



Introduction to Genetics

Introduction to Genetics

NATASHA RAMROOP SINGH

THOMPSON RIVERS UNIVERSITY
KAMLOOPS, BC



Introduction to Genetics by Natasha Ramroop Singh, Thompson Rivers University is licensed under a [Creative Commons Attribution-NonCommercial-ShareAlike 4.0 International License](#), except where otherwise noted.

© 2023 Natasha Ramroop Singh

[Introduction to Genetics](#) by Natasha Ramroop Singh was adapted from [Open Genetics Lectures \(Fall 2017\)](#) by John Locke, which is licensed under a [CC BY-NC-SA 4.0 licence](#). The following changes are by Natasha Ramroop Singh and licensed under a [CC BY-NC-SA 4.0 licence](#):

- Moved the book into Pressbooks
- Reorganized chapters
- Added learning objectives
- Adapted the chapters to remove or reword content
- Add pictures, videos, H5P activities

OPEN GENETICS (OG) – History

The first edition of this textbook, called **OPEN GENETICS**, was produced in January, 2009 as instructional material for students in Biology 207 at the University of Alberta, and was released to the public for non-commercial use under the Creative Commons License (See below). Users were encouraged to make modifications and improvements to the book. All the text in the original 2009 edition was written by Michael Deyholos, Ph.D. In subsequent editions (2010–2014), additional chapters were written by Mike Harrington, Ph.D., at the University of Alberta. Additional content and editing by John Locke, Ph.D. and Mark Wolansky, M.Sc., at the University of Alberta. Photos and some diagrams were obtained from various, non-copyrighted sources, including Flickr, Wikipedia, Public Library of Science, and Wikimedia Commons. Photo attributions are listed in the legend with each image.

Open Genetic Lectures (OGL) – Origin 2015, Updated Summer 2016, 2017, 2018, & 2019

OGL is an alternative approach to an open source textbook. Much of its content is derived from the OG textbook. The 13 chapters in OG were cut up and distributed into 41 shorter chapters that parallel the current lecture topics in BIOL 207 (Molecular Genetics and Heredity) at the University of Alberta. More text content, figures, and chapter-end questions were added in this revision. The most recent version of OG had ~76,000 words, while the Fall 2015 version of OGL had ~128,000 words, a 68% increase.

This reorganization of OG content into OGL was accomplished during the summer of 2015 by John Locke, Mike Harrington, Lindsay Canham, and Min Ku Kang. This project was funded in part by the Alberta Open Educational Resources (ABOER) Initiative, which is made possible through an investment from the Alberta government. Lindsay Canham was supported by a grant from the Alberta Open Education Initiative (OEI) through the University of Alberta. Min Ku Kang was supported by a Summer Student Scholarship from the Centre for Teaching and Learning (CTL), University of Alberta. Without these sources of financial aid this project would not have been possible. John Locke and Michael Harrington appreciate their help, as well as that of Michael Deyholos, who initiated this endeavor. Typographical errors, rewording, and additional questions were added in the summers of 2016, 2017, and 2018 (J. Locke, M. Harrington, and K. King-Jones).

Access to OGL text files through DataVerse

The final version of this work is available via a DataVerse link:

<https://dataverse.library.ualberta.ca/dvn/dv/OpenGeneticsLectures>

This includes all the .docx files for each chapter and other relevant files. This is made available for anyone to use, adapt, or improve for educational purposes. If you have edits, improvements or additions that you wish to share under the same license terms, please contact John Locke, University of Alberta.

Locke, John, 2017, ""Open Genetics Lectures" textbook for an Introduction to Molecular Genetics and Heredity (BIOL207)", <https://doi.org/10.7939/DVN/XMUPO6>, Scholars Portal Dataverse, V1

This book was produced with Pressbooks (<https://pressbooks.com>) and rendered with Prince.

Contents

Acknowledgements	xiii
Accessibility	xiv
<u>Chapter 1 - Mendel's First Law and Meiosis</u>	
1.1 Introduction	21
1.2 Dominant and Recessive Alleles	30
1.3 Meiosis	32
1.4 One Locus on a Chromosome - Segregation - Monohybrid	41
1.5 Punnett Squares - 3:1 Ratio	48
1.6 Single Locus Test Crosses	52
Chapter 1 Summary	55
Key Terms in Chapter 1	56
Chapter 1 Study Questions	58
Chapter 1 Answers	59
<u>Chapter 2 - Mendel's Second Law: Independent Assortment</u>	
2.1 Introduction	63
2.2 Two Loci on Different Chromosomes	68
2.3 Two Loci on One Chromosome	71
2.4 A Dihybrid Cross Showing Mendel's Second Law (Independent Assortment)	75
<i>Mendel's Second Law</i>	75
<i>Assumptions of the 9:3:3:1 Ratio</i>	79
<i>Deviations from the 9:3:3:1 Phenotypic Ratio</i>	79
2.5 The Dihybrid Test Cross	81
2.6 Predicting Ratios in Genetic Crosses - Rules of Probability	84
Chapter 2 Summary	86
Key Terms in Chapter 2	87
Chapter 2 Study Questions	88
Chapter 2 Answers	89
<u>Chapter 3 - The Cell Cycle and Mitosis</u>	
3.1 Introduction	93
3.2 The Typical Cell Cycle	95

3.3 Mitosis	99
3.4 Amount of DNA (c-value) and Number of Chromosomes (n-value)	104
<i>The c-Value of the Nuclear Genome</i>	106
<i>The c-Value Paradox</i>	107
<i>The Number of Chromosomes (n-Value)</i>	109
3.5 Appearance of a Typical Nuclear Chromosome During the Cell Cycle	111
3.6 Compare and Contrast Mitosis and Meiosis	114
Chapter 3 Summary	116
Key Terms in Chapter 3	117
Chapter 3 Study Questions	118
Chapter 3 Answers	119

Chapter 4 - Pedigree Analysis

4.1 Introduction	123
4.2 Symbols used in Pedigree Charts	126
4.3 Modes of Inheritance	129
<i>Autosomal Dominant (AD)</i>	130
<i>X-Linked Dominant (XD)</i>	131
<i>Autosomal Recessive (AR)</i>	132
<i>X-Linked Recessive (XR)</i>	133
<i>Y-Linked</i>	134
4.4 Sporadic and Non-Heritable Diseases	137
4.5 Calculating Probabilities Using Pedigree Charts	139
Chapter 4 Summary	141
Key Terms in Chapter 4	142
Chapter 4 Study Questions	143
Chapter 4 Answers	145

Chapter 5 - The Complementation Test

5.1 Introduction	149
5.2 Complementation Tests and Allelism	152
5.3 Complementation Groups = Groups of Allelic Mutations	157
5.4 Transformation Rescue	161
Chapter 5 Summary	166
Key Terms in Chapter 5	167
Chapter 5 Study Questions	168
Chapter 5 Answers	169

Chapter 6 - Alleles at a Single Locus

6.1 Introduction	173
6.2 Somatic vs. Germline Mutations	176
<i>Somatic Mutations</i>	176
<i>Germline Mutations</i>	176
<i>Haploid vs. Diploid Organisms</i>	177
6.3 Alleles: Hetero-, Homo-, Hemizyosity	179
6.4 Pleiotropy vs. Polygenic Inheritance	181
6.5 Types of Dominance	184
<i>Complete Dominance</i>	185
<i>Incomplete Dominance</i>	187
<i>Co-Dominance</i>	187
6.6 Biochemical Basis of Dominance	190
6.7 Classification of Mutants	192
<i>Morphological Mutants</i>	192
<i>Lethal Mutants</i>	193
<i>Biochemical Mutants</i>	193
<i>Conditional Mutants</i>	194
6.8 Muller's Morphs	197
<i>Amorph</i>	197
<i>Hypomorph</i>	198
<i>Hypermorph</i>	199
<i>Neomorph</i>	199
<i>Antimorph</i>	200
<i>Identifying Muller's Morphs</i>	200
Chapter 6 Summary	203
Key Terms in Chapter 6	204
Chapter 6 Study Questions	205
Chapter 6 Answers	206

Chapter 7 - The Central Dogma - Mutations and Biochemical Pathways

7.1 Introduction	209
7.2 The Beadle and Tatum Experiments	215
7.3 The "One Gene: One Enzyme" Hypothesis	219
7.4 Genetic Screening and Biochemical Pathways	224

7.5 Mutations Without Detectable Phenotypes	227
<i>Silent Changes</i>	227
<i>Environment and Genetic Redundancy</i>	228
<i>Essential Genes and Lethal Alleles</i>	228
<i>Naming Genes</i>	228
7.6 Cystic Fibrosis in Humans	230
Chapter 7 Summary	233
Key Terms in Chapter 7	234
Chapter 7 Study Questions	235
Chapter 7 Answers	237

Chapter 8 - Gene Interactions

8.1 Introduction	243
8.2 Recall - Mendelian Dihybrid Crosses	246
8.3 Epistasis and Other Gene Interactions	250
<i>Recessive Epistasis</i>	250
<i>Dominant Epistasis</i>	251
<i>Duplicate Gene Action</i>	253
<i>Complementary Gene Action</i>	254
<i>Genetic Suppression and Enhancement</i>	256
<i>Summary of Modifications</i>	260
8.4 Polygenic Inheritance	264
8.5 Environmental Factors	268
8.6 Factors Causing Deviation from Mendelian Phenotypic Ratios	273
Chapter 8 Summary	275
Key Terms in Chapter 8	276
Chapter 8 Study Questions	277
Chapter 8 Answers	279

Chapter 9 - Linkage and Recombination Frequency

9.1 Introduction	287
9.2 Review of Genetic Nomenclature and Symbols	290
9.3 Recombination and Recombination Frequency	292
<i>Inter- and Intrachromosomal Recombination</i>	293
<i>Inheriting Parental and Recombinant Gametes</i>	294
<i>Recombination Frequency</i>	296
9.4 Coupling and Repulsion (cis and trans) Configuration	299

9.5 Unlinked Genes vs. Partial Linkage vs. Complete Linkage	303
<i>Unlinked Genes</i>	303
<i>Complete Linkage</i>	303
<i>Partial Linkage</i>	304
9.6 Experimental Determination of Recombination Frequency	307
Chapter 9 Summary	310
Key Terms in Chapter 9	311
Chapter 9 Study Questions	312
Chapter 9 Answers	313
<u>Chapter 10 - Sex Chromosomes & Sex Linkage</u>	
10.1 Introduction	317
10.2 Autosomes and Sex Chromosomes	321
10.3 Pseudo-Autosomal Regions on the X and Y Chromosomes	324
10.4 Sex Linkage: An Exception to Mendel's First Law	327
10.5 Y-Linked Genes	331
Chapter 10 Summary	334
Key Terms in Chapter 10	335
Chapter 10 Study Questions	336
Chapter 10 Answers	337
<u>Chapter 11 - Recombination Mapping of Gene Loci</u>	
11.1 Introduction	341
11.2 Genetic Mapping	344
<i>Calculating Map Distance</i>	344
<i>Map Distance Over Long Chromosomes</i>	347
<i>Genetic Maps are an Approximation</i>	348
11.3 Two-Point and Three-Point Crosses	350
<i>Two-Point Crosses</i>	350
<i>Three-Point Crosses</i>	353
11.4 Coincidence and Interference	363
Chapter 11 Summary	366
Key Terms in Chapter 11	367
Chapter 11 Study Questions	368
Chapter 11 Answers	370
<u>Chapter 12 - Physical Mapping of Chromosomes and Genomes</u>	
12.1 Introduction	375

12.2 Genetic Maps	378
12.3 Cytogenetic Maps	384
12.4 Physical Maps	391
Chapter 12 Summary	396
Key Terms in Chapter 12	397
Chapter 12 Study Questions	398
Chapter 12 Answers	399
 <u>Chapter 13 - Genes and COVID-19 Susceptibility in Humans</u>	
13.1 Introduction	403
13.2 How Does SARS-Cov-2 Infect Humans?	406
13.3 Genes Implicated in Severe COVID-19 Infection in Humans	409
13.4 Approaches for Vaccine Development Against SARS-Cov-2	412
Chapter 13 Summary	416
Key Terms in Chapter 13	417
Appendix A: Key Milestones in Genetics and Molecular Biology Timeline	419

Acknowledgements

Many thanks goes out to:

Michael Deyholos, Mike Harrington, John Locke and Mark Wolansky – (U of A) – for their gargantuan efforts in putting together the original material from which this Open textbook is derived;

Thompson Rivers University for providing an Open Educational Resource Development Grant (OERDG) to support the modification and adaptation of this textbook for students enrolled in BIOL 2340/2341 (Introduction to Genetics) at TRU;

Brenda Smith (TRU) and Christine Miller (TRU) for championing the OER movement at TRU; and last but not least,

Danielle Collins (TRU) for unwavering expert editing and overall support and advice.

Accessibility

The web version of [Introduction to Genetics](#) has been designed to meet [Web Content Accessibility Guidelines 2.0](#), level AA. In addition, it follows all guidelines in [Appendix A: Checklist for Accessibility](#) of the [Accessibility Toolkit – 2nd Edition](#). It includes:

- **Easy navigation.** This resource has a linked table of contents and uses headings in each chapter to make navigation easy.
- **Accessible videos.** All videos in this resource have captions.
- **Accessible images.** All images in this resource that convey information have alternative text. Images that are decorative have empty alternative text.
- **Accessible links.** All links use descriptive link text.

Accessibility Checklist		
Element	Requirements	Pass?
Headings	Content is organized under headings and subheadings that are used sequentially.	Yes
Images	Images that convey information include alternative text descriptions. These descriptions are provided in the alt text field, in the surrounding text, or linked to as a long description.	Yes
Images	Images and text do not rely on colour to convey information.	Yes
Images	Images that are purely decorative or are already described in the surrounding text contain empty alternative text descriptions. (Descriptive text is unnecessary if the image doesn't convey contextual content information.)	Yes
Tables	Tables include row and/or column headers that have the correct scope assigned.	Yes
Tables	Tables include a title or caption.	Yes
Tables	Tables do not have merged or split cells.	Yes
Tables	Tables have adequate cell padding.	Yes
Links	The link text describes the destination of the link.	Yes
Links	Links do not open new windows or tabs. If they do, a textual reference is included in the link text.	Yes
Links	Links to files include the file type in the link text.	Yes
Video	All videos include high-quality (i.e., not machine generated) captions of all speech content and relevant non-speech content.	No
Video	All videos with contextual visuals (graphs, charts, etc.) are described audibly in the video.	Yes
H5P	All H5P activities have been tested for accessibility by the H5P team, and passed their testing.	Yes
H5P	All H5P activities that include images, videos, and/or audio content meet the accessibility requirements for those media types.	Yes
Font	Font size is 12 point or higher for body text.	Yes
Font	Font size is 9 point for footnotes or endnotes.	Yes
Font	Font size can be zoomed to 200% in the webbook or eBook formats.	Yes

Known Accessibility Issues and Areas for Improvement

- Tables use merged cells, but they have been structured to work properly with screen readers.
- These videos do not have edited captions:

- Chapter 1

- [History of Research on Genetics](#), by Sigma Documentaries (2017)
- [Dominant Alleles vs Recessive Alleles | Understanding Inheritance](#) by 2 Minute Classroom (2017)
- [Law of Segregation \(Mendel's First Law of Inheritance\)](#) by FL-Genetics/03 (2018)
- [Monohybrid Cross Examples – GCSE Biology](#) (9-10), by Mr. Exham Biology (2018)
- [Testcross Explained](#), by Nicole Lantz (2020)
- **Chapter 2**
 - [Law of Independent Assortment](#), by AK Lecture Series (2015)
 - [Dihybrid Cross Explained](#), by Nicole Lantz (2020)
 - [Two-Gene Test Cross Explained](#), by Nicole Lantz (2020)
- **Chapter 3**
 - [Cell Biology |Cell Cycle: Interphase & Mitosis](#), by Ninja Nerd (2018)
 - [Animation How the Cell Cycle Works](#), by Marcin Gorzycki (2018)
 - [Mitosis vs. Meiosis](#), by Beverly Biology (2014)
- **Chapter 4**
 - [Pedigree Analysis](#), by AK Lecture Series (2015)
 - [Pedigree Analysis](#), by Nicole Lantz (2016)
- **Chapter 6**
 - [2H – Somatic & germline mutations](#), presented by Professor Redfield of UBC (Useful Genetics, 2015)
 - [The Life Cycle of Yeast – Professor Rhona Borts](#), from University of Leicester (2010)
 - [Homozygous, Heterozygous, Hemizygous, Haploid](#), by Nikolay's Genetics Lessons (2015)
- **Chapter 7**
 - [Inborn Error of Metabolism: Alkaptonuria](#), by Walter Jahn (2016)
 - [Beadle and Tatum Part 1: Neurospora crassa](#), by SciencePrimer (2018)
 - [BIOL 183: Beadle & Tatum's One-Gene-One-Enzyme hypothesis](#), by Susan Bush (2020)
 - [Gene Interactions Pt. 1](#), by Michelle Stieber (2014)
 - [Genetic Screen](#), by Animated biology With arpan (2017)
 - [Genetic Systems for Detecting Mutation](#), by Alex Nieves (2020)
 - [Silent \(Synonymous\) Mutations of a Gene Explained](#), by Nikolay's Genetics Lessons (2020)
 - [Cystic Fibrosis | Molecular Mechanism & Genetics](#), by Hussain Biology (2018)
- **Chapter 8**
 - [Gene Interaction IB Biology](#), by Alex Lee (2016)
 - [Polygenic Inheritance](#), by AK Lectures (2015)
 - [Penetrance vs. Expressivity](#), by The Excel Cycle (2020)
 - [Extension of Mendelism – Phenocopy, Incomplete Penetrance, Expressivity \(BI_08\)](#), by Biology Insights (2020)
- **Chapter 9**
 - [Genetic Linkage](#), by Steve Baskauf (2015) (EN – autogenerated)
 - [Recombination Frequency and Linked Genes](#), by John Chapman (2013)
 - [Linked Genes, Crossing Over and Genetic Recombination](#), by AK Lectures (2015) on YouTube.
 - [Genetics! coupling \(cis\) vs Repulsion \(trans\)](#), by Medaphysics Repository (2015)
 - [\(AP Biology\) Linked Genes, Unlinked Genes, Incomplete Linkage, and Gene Mapping](#), by Mr. Cronin's Videos (2019)
- **Chapter 10**
 - [Sex Determination | Genetics | Biology | FuseSchool](#), presented by FuseSchool – Global Education (2017)

- [7R – Sex chromosomes in Meiosis](#), produced by Professor Redfield of UBC (Useful Genetics, 2015)
- [Sex Chromosome Abnormalities](#), part of the AK Lectures (2015)
- [Sex determination by the Y chromosome](#), by Genetics/ UC Davis (2017)
- [X-Linked Genes: Patterns of Inheritance by Oxford Academic](#) (Oxford University Press, 2017)
- **Chapter 11**
 - [Gene Mapping, Percent Recombination and Map Units](#), by AK Lectures (2015)
 - [Interference and Coincidence](#), by Catalyst University (2018)
 - [Genetics: Linkage Problem #1](#), by Chegg (2018)
- **Chapter 12**
 - [8H – Physical and Genetic Linkage and Maps](#), by Professor Redfield (Useful Genetics, 2015)
 - [Gene Mapping/ How to Decode 13q14.3](#), by Medinaz (2017)
 - [Genetics – Cytogenetic Maps Part 6 of 6](#), by SCOOTERDMU (2011)
- **Chapter 13**
 - [COVID-19 | Coronavirus: Epidemiology, Pathophysiology, Diagnostics](#), by Ninja Nerd (2020)
 - [How the Novel Coronavirus Infects a Cell: Science, Simplified](#), by Scripps Research (2020)
 - [Rare Genetic Variants May Predispose to Severe COVID-19](#), by Bionano Genomics (2021)
 - [There are Four Types of COVID-19 Vaccines: Here's How They Work](#), by Gavi, the Vaccine Alliance (2020)

Adapted from the [Accessibility Toolkit – 2nd Edition](#) by BCcampus, licensed under [CC-BY](#).

CHAPTER 1 - MENDEL'S FIRST LAW AND MEIOSIS

1.1 Introduction

Learning Objectives

- Discuss Gregor Mendel's discovery of the Principles of Heredity and comment on why he was successful.
- Establish and analyze monohybrid crosses.
- Describe how monohybrid crosses reveal the Principle of Segregation and the Concept of Dominance.
- Apply a test cross to identify genotypes in individuals expressing one dominant trait.
- Apply probability to predict genotypic and phenotypic ratios in monohybrid crosses.

Gregor Mendel's Principles of Inheritance

Gregor Mendel's principles of inheritance form the cornerstone of modern genetics. Mendel (**Figure 1.1.1**) was an Augustinian monk and plant breeder who conducted a series of simple, yet elegant, experiments in 1865. He was one of the first to take a quantitative, scientific approach to the study of heredity.



Figure 1.1.1 Gregor Johann Mendel (1822-1884). Mendel was an Augustinian Friar, who lived in Moravia (now part of the Czech Republic). He published his work in 1866 on what has become known as the laws of Mendelian Inheritance. [[Long description](#)]

Mendel started with well-characterized strains, repeated his experiments many times, and kept careful records of his observations. He used the garden pea plant (*Pisum sativum* – **Figure 1.1.2**) with which to conduct his studies.



Figure 1.1.2 Pea Plants Were Used by Gregor Mendel to Discover Fundamental Laws of Genetics [[Long description](#)]



Figure 1.1.3 Closeup of Pollen on a Cosmetic Brush for Use in Hand-Pollinating [[Long description](#)]

This garden pea plant was an excellent choice for Mendel, for the following four reasons:

1. Peas had been shown to be true-breeding (all offspring will have the same characteristic generation after generation).
2. Peas exhibit a variety of contrasting traits (purple vs. white flowers; round vs. wrinkled seeds).
3. The shape of the pea flower protected it from foreign pollen. Peas usually reproduce by self-pollination, in which pollen produced by a flower fertilizes eggs in the same flower.
4. Pea plants grow quickly and do not require much space.

The seven (7) traits that Mendel studied are as follows:

- Form of ripe seed (R) – smooth or wrinkled
- Colour of seed albumen (Y) – yellow or green
- Colour of flower (P) – purple or white
- Form of ripe pods (I) – inflated or constricted
- Colour of unripe pods (G) – green or yellow
- Position of flowers (A) – axial or terminal
- Length of stem (T) – tall or dwarf















Characteristics of pea plants Gregor Mendel used in his inheritance experiments						
Seeds		Flower colour	Pod		Stem	
form	cotyledons		form	colour	position of inflorescences	size
 round roundish	 yellow	 white	 full	 yellow	 axial	 long
 wrinkled	 green	 violett-red	 constricted between the seeds	 green	 terminal	 short

Figure 1.1.4 Characteristics of Pea Plants Gregor Mendel Used in Inheritance Experiments. These are the seven traits in garden peas that Gregor Mendel, the founder of genetics, experimented with as he was studying the principles of genetics in the 1850s & 1860s. [[Long description](#)]

After eight years of tedious experiments with these plants, Mendel proposed his foundational principles of inheritance. Mendel showed that white-flowered plants could be produced by crossing two purple-flowered plants, but only if the purple-flowered plants themselves had at least one white-flowered parent ([Figure 1.1.5](#)). This was evidence that a discrete genetic factor that produced white-flowers had not blended irreversibly with the factor for purple-flowers. Mendel's observations disproved blending inheritance and favoured an alternative concept, called **particulate inheritance**, in which heredity is the product of discrete factors that control independent traits.

Through careful study of patterns of inheritance, Mendel recognized that a single trait could exist in different versions, or **alleles**, even within an individual plant or animal. For example, he found two allelic forms of a gene for seed colour: one allele gave green seeds, and the other gave yellow seeds. Mendel also observed that although different alleles could influence a single trait, they remained indivisible and could be inherited separately. This is the basis of **Mendel's First Law**, also called **The Law of Equal Segregation**, which states that, during gamete formation the two alleles at a gene locus segregate from each other, and each gamete has an equal probability of containing either allele.

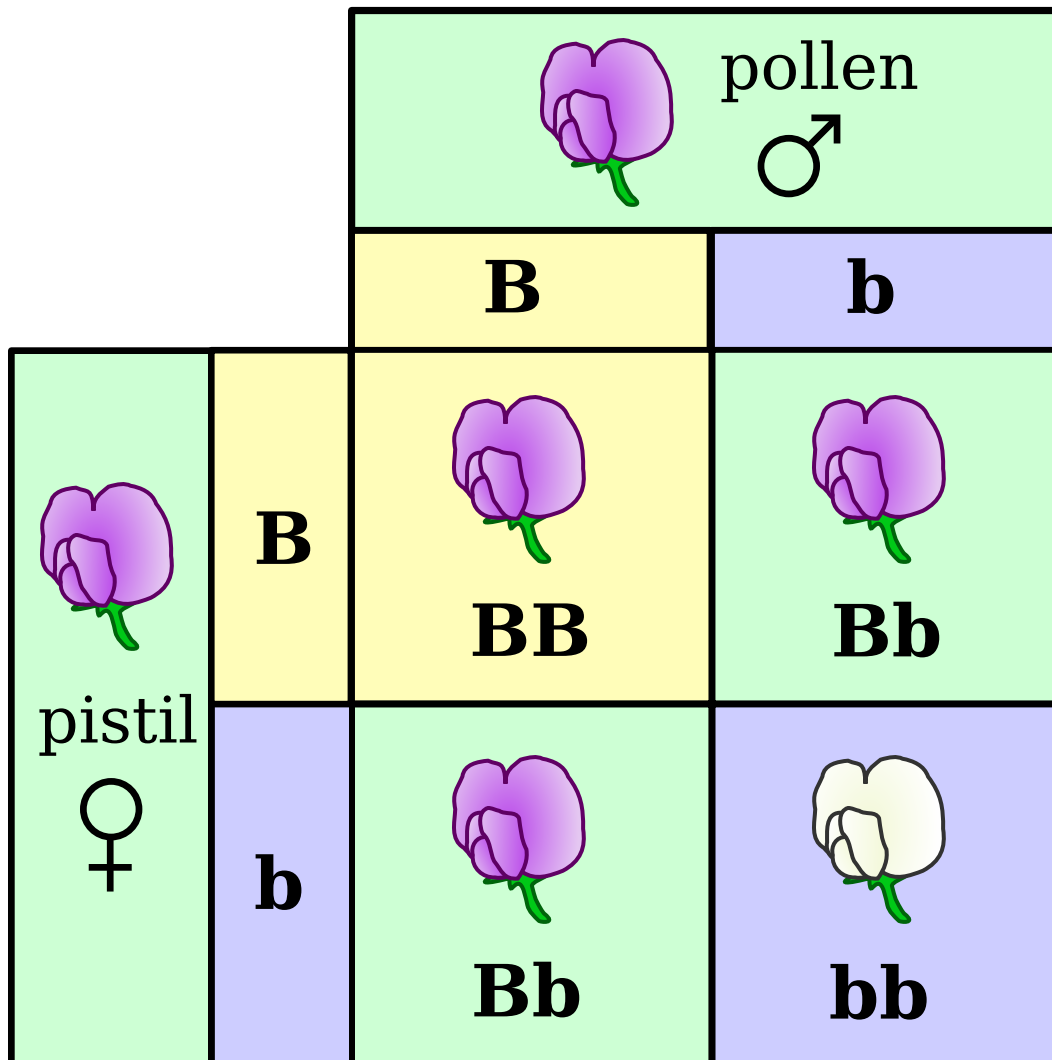

Figure 1.15 Punnett Square Demonstrating Mendel's Cross Between Purple and White Flowers. This Punnett Square illustrates a 3:1 ratio of purple: white flowers in the offspring (F1 generation). [[Long description](#)]

Genes

Mendel first made his discoveries of inheritance in the 1850s. In his 1866 publication, [Experiments on Plant Hybridization](#), he didn't use the word "gene" as the fundamental unit of heredity because it wasn't coined until 1909 by Danish botanist [Wilhelm Johannsen](#). [Thomas Hunt Morgan](#) proposed that genes resided on chromosomes in 1910, and occupied distinct regions on those chromosomes. DNA as a substance was discovered in the 1860s, but it took until the 1940s to realize that DNA was the molecule that contained the genetic information. Then in the 1950s Watson and Crick discovered the structure of DNA. Take a look at the video, "A History of Research on Genetics" by Sigma Documentaries on YouTube, which summarizes some of these landmark studies.

Watch this video, *History of Research on Genetics*, by Sigma Documentaries (2017) on YouTube.



A YouTube element has been excluded from this version of the text. You can view it online here:

<https://opengenetics.pressbooks.tru.ca/?p=190>

Key Milestones in Genetics and Molecular Biology



An interactive or media element has been excluded from this version of the text. You can view it online here:

<https://opengenetics.pressbooks.tru.ca/?p=190>

Note: If you are not using the online version of this guide, you can find the timeline in [Appendix A:Key Milestones in Genetics and Molecular Biology Timeline](#)

Media Attributions

- **Figure 1.1.1** [Portrait of Mendel in Oval](#), by Hugo Iltis/Wellcome, [CC BY 4.0](#), via Wikipedia
- **Figure 1.1.2** [File:Peultjes peultjes Pisum sativum mange-tout](#) by [Rasbak](#), [CC BY-SA 3.0](#) via Wikimedia Commons
- **Figure 1.1.3** [closeup of Ka'ū silversword pollen](#) by Wei/ Hawai'i Volcanoes NPS (2017), is [CC PDM 1.0](#) (public domain mark), via Flickr
- **Figure 1.1.4** [Gregor Mendel, Characteristics of Pea Plants](#) (reworked by [Sciencia58](#)), [LadyofHats](#), [CC0](#), via

Wikimedia Commons

- **Figure 1.1.5 Punnett square Mendel flowers** by [Madprime](#) is licensed under [CC BY-SA 3.0](#), via Wikimedia Commons

References

- A&E Television Networks. (2009, November 24). James D. Watson and Francis H.C. Crick (image). *Chemical structure of DNA discovered*. History.com. <https://www.history.com/this-day-in-history/watson-and-crick-discover-chemical-structure-of-dna>.
- Hurmerinta S. (2014, August). Day 227/366 [image]. Flickr. <https://www.flickr.com/photos/explodingfish/8156844439/in/photolist-dqMXEX>
- Hugo Iltis/Wellcome. (2020, September 9). File:Portrait of Mendel in oval. Wellcome M0014816.jpg [image]. *Wikimedia Commons*. https://commons.wikimedia.org/w/index.php?title=File:Portrait_of_Mendel_in_oval._Wellcome_M0014816.jpg&oldid=453284612.
- John Murray (Publisher). (2020, November 24). File:Origin of Species title page [digital image]. *Wikimedia Commons*. https://commons.wikimedia.org/w/index.php?title=File:Origin_of_Species_title_page.jpg&oldid=514806088.
- Madprime. (2020, September 15). File:Punnett square mendel flowers.svg [image]. *Wikimedia Commons*. https://commons.wikimedia.org/w/index.php?title=File:Punnett_square_mendel_flowers.svg&oldid=460082081.
- Maramorosch, K. (1953). Martha Chase and Alfred D. Hershey [photograph]. *Linus Pauling and the Race for DNA: A Documentary History*. Special Collections & Archives Research Center, Oregon State University Libraries. <http://scarc.library.oregonstate.edu/coll/pauling/dna/pictures/portrait-hersheychase.html>
- Ruiz Villarreal, M. [user: ladyofhats]. (2018, October 9). File:Gregor Mendel – characteristics of pea plants – english [digital image – reworked by user: Scienza58]. *Wikimedia Commons*. https://commons.wikimedia.org/wiki/File:Gregor_Mendel_-_characteristics_of_pea_plants_-_english.png
- Rasbak. (2020, October 13). File:Peultjes peultjes Pisum sativum mange-tout.jpg. *Wikimedia Commons*. https://commons.wikimedia.org/w/index.php?title=File:Peultjes_peultjes_Pisum_sativum_mange-tout.jpg&oldid=488730288.
- Rye, C., Wise, R., Jurukovski, V., DeSaix, J., Choi, J., Yael Avissar, Y. (2016, October 21). Figure 13.3 Inheritance patterns of unlinked and linked genes [digital image]. In *Biology*. OpenStax. <https://openstax.org/books/biology/pages/13-1-chromosomal-theory-and-genetic-linkage>. Access for free at <https://openstax.org/books/biology/pages/1-introduction>
- Scienza58. (2021, January 4). File:Gregor Mendel – characteristics of pea plants – english.png (image). *Wikimedia Commons*. https://commons.wikimedia.org/w/index.php?title=File:Gregor_Mendel_-_characteristics_of_pea_plants_-_english.png&oldid=524031116 (Original by Mariana Ruiz Villarreal/ LadyofHats)
- Sigma Documentaries. (2017, January 29). A History of Research on Genetics (video). YouTube. <https://www.youtube.com/watch?v=LMEy9uiu-Wk&feature=youtu.be>.
- Wei, J./Hawaii Volcanoes National Park. (2017). Closeup of Ka'ū silversword pollen on a cosmetic brush for use in hand-pollinating (NPS photo). Flickr. <https://www.flickr.com/photos/144356245@N06/35215975004>

Wikipedia contributors. (2021, February 16). Thomas Hunt Morgan. *Wikipedia*. https://en.wikipedia.org/w/index.php?title=Thomas_Hunt_Morgan&oldid=1007173283

Wikipedia contributors. (2020, December 10). Wilhelm Johannsen. *Wikipedia*. https://en.wikipedia.org/w/index.php?title=Wilhelm_Johannsen&oldid=993478431

Long Descriptions

- **Figure 1.1.1** Headshot of Gregor Mendel, the Augustinian monk, pictured with a receding hairline, wearing a black robe, spectacles and a cross around his neck. [Back to [Figure 1.1.1](#)]
- **Figure 1.1.2** Garden peas appear with many green leaves, tall green stems, green pea pods, and a few white flowers. [Back to [Figure 1.1.2](#)]
- **Figure 1.1.3** A medium bristled paint brush with yellow pollen dust on the tip of the brush is used for hand-pollination. [Back to [Figure 1.1.3](#)]
- **Figure 1.1.4** The seven traits in garden peas Mendel experimented with are: 1) round and wrinkled seeds; 2) yellow and green seeds; 3) white and purple flowers; 4) full and constricted pods; 5) yellow and green pods; 6) axial and terminal stems; and 7) long and short stems. [Back to [Figure 1.1.4](#)]
- **Figure 1.1.5** A Punnett square illustrates the segregation of alleles in male and female parents in a monohybrid cross, to produce four offspring in a 3:1 phenotypic ratio. A purple flowered male is crossed with a purple flowered female. Both parents are heterozygous (Bb). Offspring are 1 homozygous dominant (BB), 2 heterozygous (Bb) and 1 homozygous recessive (bb). [Back to [Figure 1.1.5](#)]

1.2 Dominant and Recessive Alleles

What is the Phenotype of a Heterozygote?

The dominant/recessive character is a relationship between two alleles and must be determined by observation of the heterozygous phenotype.

An example of a simple phenotype is the flower colour in Mendel's peas. One allele as a homozygote produces purple flowers, while the other allele as a homozygote produces white flowers. But what about a heterozygous individual that has one purple allele and one white allele? What is the phenotype of a heterozygote?

This can only be determined by experimental observation. We know from observation that individuals heterozygous for the purple and white alleles of the flower colour gene have purple flowers. Thus, the allele associated with purple color is therefore said to be **dominant** to the allele that produces the white colour. The white allele, whose phenotype is masked by the purple allele in a heterozygote, is **recessive** to the purple allele.

Look at the video, *Dominant Alleles vs Recessive Alleles | Understanding Inheritance* by 2 Minute Classroom (2017) on YouTube, which gives an overview of dominant and recessive alleles.

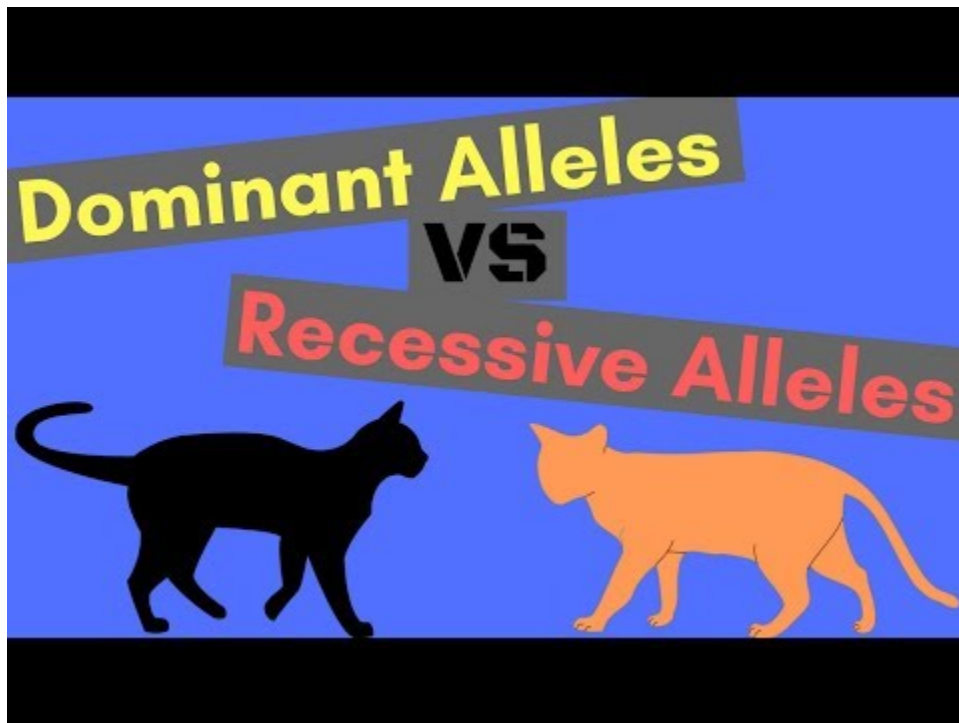

A YouTube element has been excluded from this version of the text. You can view it online here:

<https://opengenetics.pressbooks.tru.ca/?p=200>

Remember, alleles are different versions of a gene. The relationship of different alleles of a gene can be described

as complete dominance, incomplete dominance, or co-dominance. The traits Mendel studied with his peas were all completely dominant, and therefore will only be briefly reviewed here.

In a diploid organism, if an allele is **dominant**, only one copy of that allele is necessary to express the dominant phenotype. If an allele is **recessive**, then the gene needs to have two copies (or be homozygous) to express the recessive phenotype. If an organism is a heterozygote, or has one copy of each allele type, then it will show the dominant phenotype. When representing these in written form, a dominant allele is written as a capital letter (e.g., A), while a recessive allele will be written in lower case (e.g., a). If these are alleles of the same gene, they should be written with the same letter. This is the most common way of writing genotypes (**Table 1.2.1**), but there are many different systems that often deviate from these general rules. Note that genes and alleles are usually written in *italics* and chromosomes and proteins are not. Proteins are often written in all capitals. For example, the *white* gene (*w*) in *Drosophila melanogaster* on the X chromosome encodes a protein called WHITE.

Table 1.2.1 Examples of Symbols Used to Represent Genes and Alleles

Alleles	Meanings
A and a	Uppercase letters represent dominant alleles and lowercase letters indicate recessive alleles. Mendel invented this system but it is not commonly used because not all alleles show complete dominance and many genes have more than two alleles.
a ⁺ and a ¹	Superscripts or subscripts are used to indicate alleles. For wild type alleles the symbol is a superscript +.
AA or A/A	Sometimes a forward slash is used to indicate that the two symbols are alleles of the same gene, but on homologous chromosomes.

References

2 Minute Classroom. (2017, February 4). *Dominant Alleles vs Recessive Alleles | Understanding Inheritance* [Video file]. YouTube. https://www.youtube.com/watch?v=G-_fwABa2BU&feature=youtu.be

1.3 Meiosis

Stages of Meiosis

Most eukaryotes reproduce sexually – a cell from one individual joins with a cell from another to create offspring. To be successful, the cells that fuse must contain half the number of chromosomes as in the adult organism. Otherwise, the number of chromosomes would double with each generation, which would be unsustainable. The chromosome number is reduced through the process of **meiosis**. Meiosis is similar in many ways to mitosis, as the chromosomes are lined up along the metaphase plate and divided to the poles using microtubules. It also differs in many significant ways from mitosis.

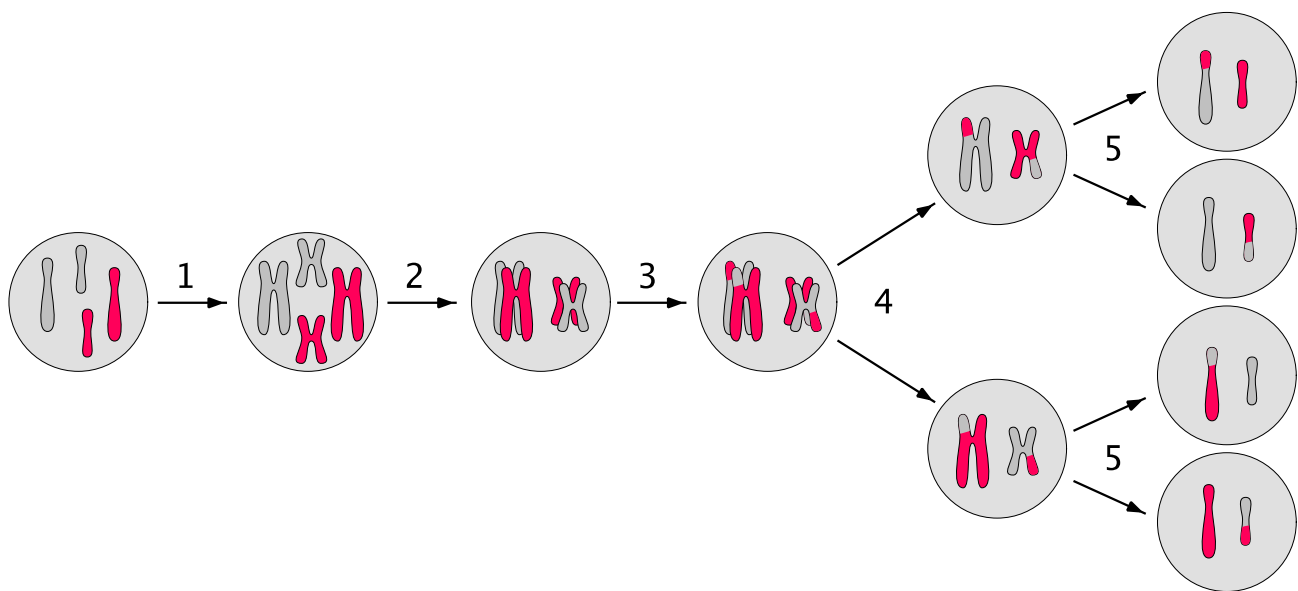

Figure 1.3.1 Simplified Stages of Meiosis [\[Long description\]](#)

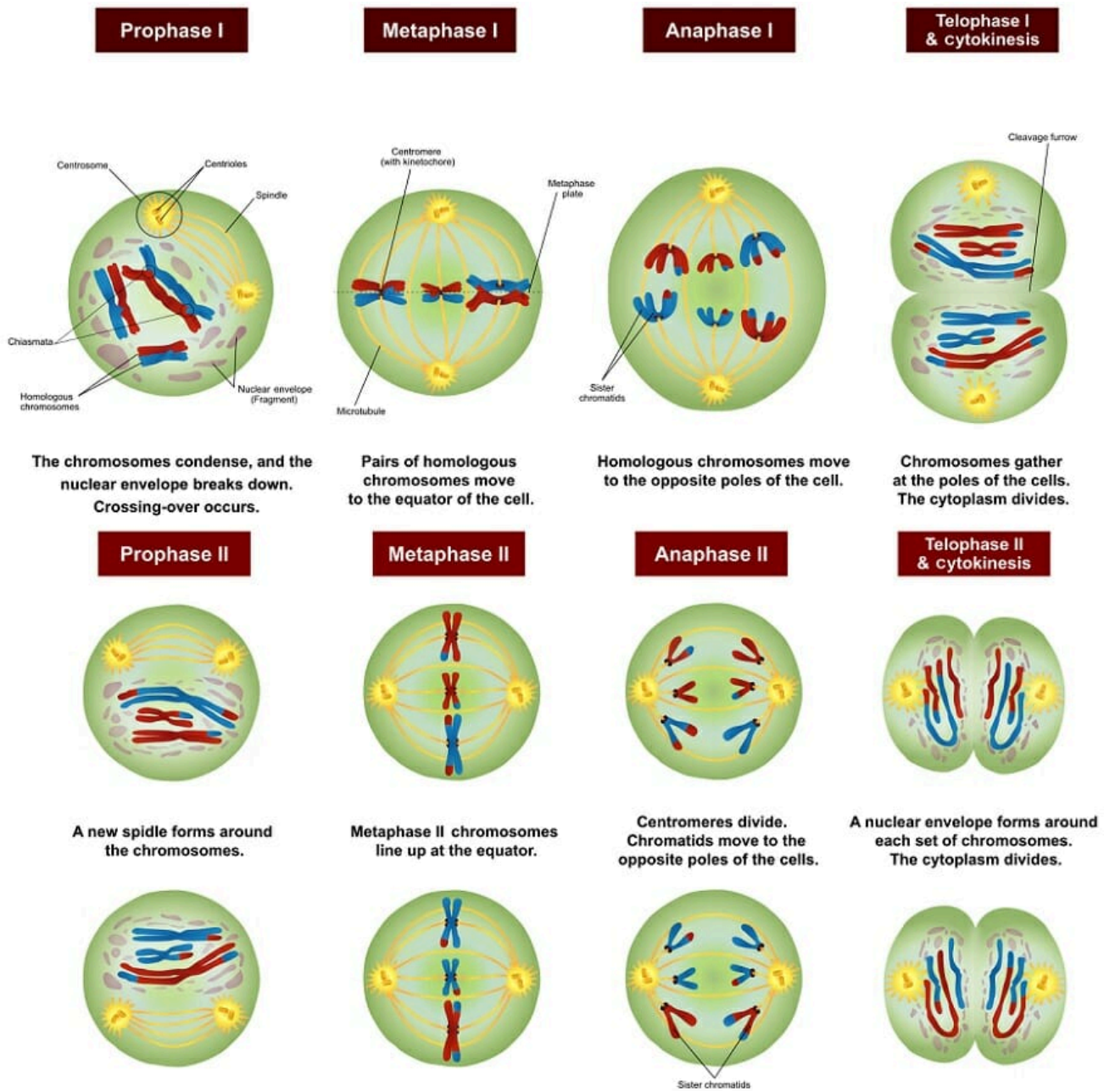

Figure 1.3.2 Detailed Stages of Meiosis [Long description]

Meiosis I and Meiosis II

Meiosis has two main stages, designated by the roman numerals I and II. In **Meiosis I** homologous chromosomes segregate, while in **Meiosis II** sister chromatids segregate (Figure 1.3.2). Most multicellular organisms use meiosis to produce **gametes**, the cells that fuse to make offspring. Some single celled eukaryotes such as yeast also use meiosis to enter the haploid part of their life cycle. Cells that will undergo meiosis are called **meiocytes** and are diploid ($2N$) (Figure 1.3.3 and Figure 1.3.4). You will hear of cells that have not yet undergone meiosis to become egg or sperm cells called oocytes or spermatocytes respectively.

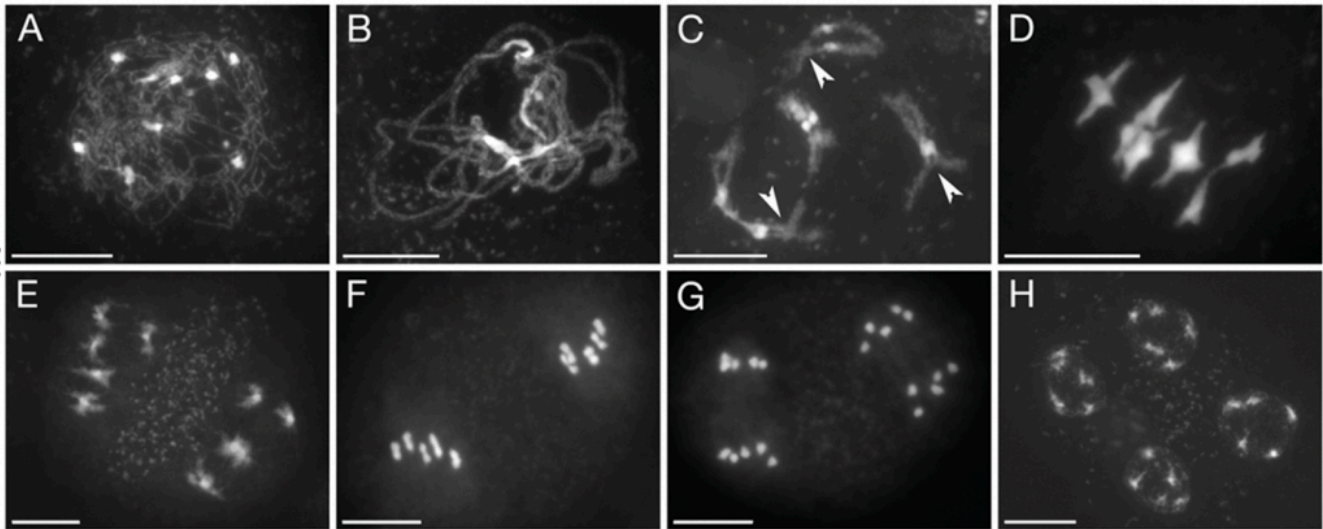

Figure 1.3.3 Meiosis in *Arabidopsis* ($n=5$). Note. Panels A-C show different stages of prophase I, each with an increasing degree of chromosome condensation. Subsequent phases are shown: metaphase I (D), telophase I (E), metaphase II (F), anaphase II (G), and telophase II (H). [[Long description](#)]

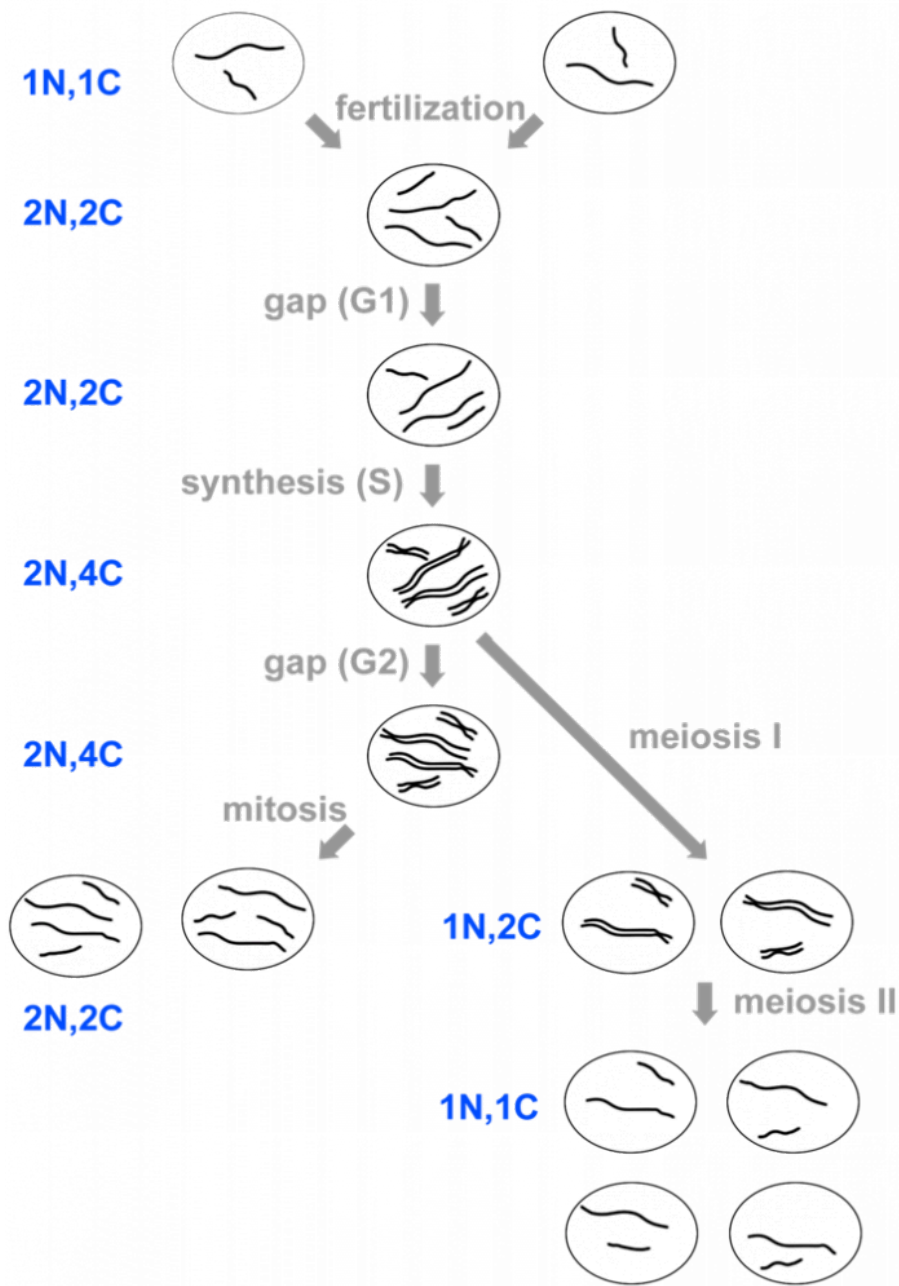

Figure 13.4 Changes in DNA and Chromosome Content During the Cell Cycle. Note: For simplicity, nuclear membranes are not shown, and all chromosomes are represented in a similar stage of condensation. [\[Long description\]](#)

Meiosis begins similarly to mitosis in that a cell has grown large enough to divide and has replicated its chromosomes. However, Meiosis requires two rounds of division. In the first, known as Meiosis I, the replicated, homologous chromosomes segregate. During Meiosis II the sister chromatids segregate. Note how Meiosis I and II are both divided into prophase, metaphase, anaphase, and telophase, since those stages have similar features to mitosis. After two rounds of cytokinesis, four cells will be produced, each with a single copy of each chromosome in the set.

Meiosis I

Meiosis I is called a **reductional** division, because it reduces the number of chromosomes inherited in each of the daughter cells – the parent cell is $2N$ while the two daughter cells are each $1N$. Meiosis I is further divided into Prophase I, Metaphase I, Anaphase I, and Telophase I, which are roughly similar to the corresponding stages of mitosis, except that in Prophase I and Metaphase I, homologous chromosomes **pair up** with each other, or **synapse**, and are called **bivalents** (Figure 1.3.5), in contrast with mitosis where the chromosomes line up individually during metaphase. This is an important difference between mitosis and meiosis, because it affects the segregation of alleles, and also allows for recombination to occur through crossing-over, which will be described later. During Anaphase I, one member of each pair of homologous chromosomes migrates to each daughter cell ($1N$) (Figure 1.3.4).

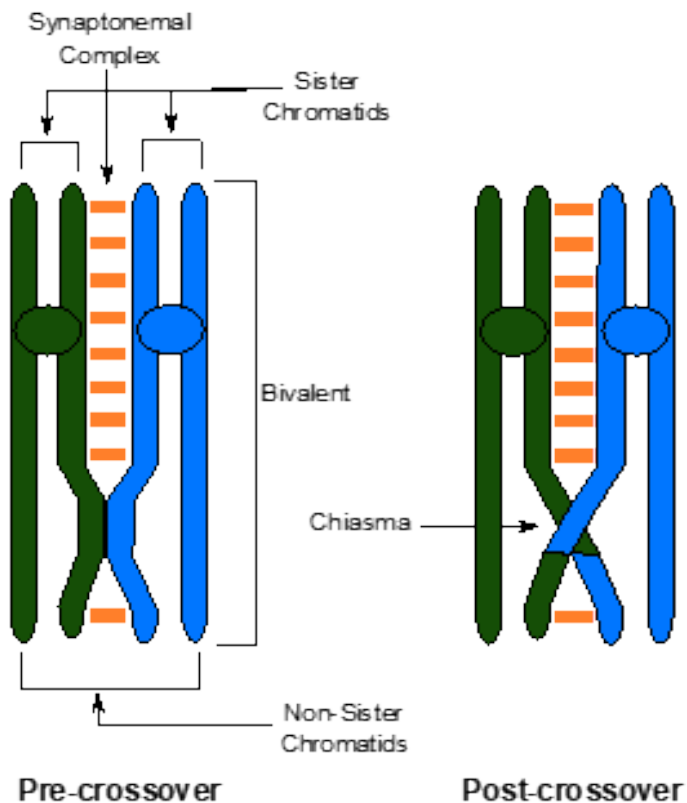

Figure 1.3.5 Diagram of a Pair of Homologous Chromosomes During Prophase I [[Long description](#)]

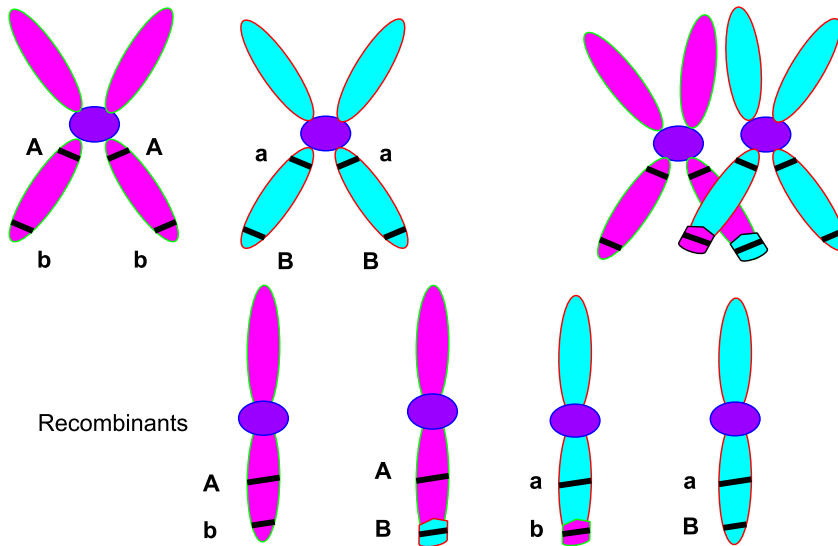

Figure 13.6 Recombinant Chromosomes Produced via Crossing Over [[Long description](#)]

During Prophase I, the homologous chromosomes pair together and form a synaptonemal complex. **Crossing over** occurs within the synaptonemal complex. A crossover is a place where DNA repair enzymes break the DNA of two non-sister chromatids in similar locations and then covalently reattach non-sister chromatids together to create a crossover between non-sister chromatids. This reorganization of chromatids will persist for the remainder of meiosis and result in recombination of alleles in the gametes. Crossover events can be seen as **Chiasmata** on the synapsed chromosomes in late Meiosis I. Crossovers function to hold homologous chromosomes together during meiosis I so they orient correctly and segregate successfully. Crossing over also reshuffles the allele combinations along a chromosome resulting in genetic diversity, that can be selected in a population over time (evolution).

In Meiosis I, homologous chromosomes pair up, or synapse, during prophase I, line up in the middle of the cell during Metaphase I, and separate during Anaphase I. For this to happen, the homologous chromosomes need to be brought together while they condense during Prophase I. During synapsis, proteins bind to both homologous chromosomes along their entire length and form the **synaptonemal complex** (synapse means junction). These proteins hold the chromosomes in the transient structure of a bivalent (**Figure 13.5**). The proteins are released when the cell enters Anaphase I.

Summary of the Stages of Meiosis I

Meiosis I – A Reductional Division

Prophase I – Initially, chromosomes condense and become visible and centrosomes begin to migrate to opposite poles of the cell; Homologous chromosomes enter synapsis and the synaptonemal complex forms; Crossing over occurs resulting in an exchange of genetic material between non-sister chromatids of a homologous chromosome pair; Following this, the synaptonemal complex disappears and tetrads are visible; crossover points appear as chiasmata which hold non-sister chromatids together; finally, chromatids thicken and shorten, the nuclear membrane dissolves and spindle fibers begin forming.

Metaphase I – Tetrads line up on the equator or the metaphase plate and each chromosome of a homologous pair attaches to spindle fibers from opposite ends of the poles – sister chromatids attach to fibers from the same pole.

Anaphase I – Chiasmata dissolve; homologous chromosomes move to opposite poles; note: centromeres do not separate here.

Telophase I – The nuclear envelope reforms and the resulting cells have half the number of chromosomes, each consisting of two sister chromatids.

Interkinesis/Cytokinesis – Similar to interphase except no chromosome duplication occurs. Daughter nuclei become enclosed into separate daughter cells.

Meiosis II

At the completion of Meiosis I, there are two cells, each with one, replicated copy of each chromosome (1N). Because the number of chromosomes per cell has decreased (2→1), Meiosis I is called a **reductional cell division**. Meiosis II resembles mitosis, with one sister chromatid from each chromosome separating to produce two daughter cells. Because Meiosis II, like mitosis, results in the segregation of sister chromatids, Meiosis II is called an **equational division** (**Figure 1.3.4**).

Summary of the Stages of Meiosis II

Meiosis II – An Equational Division

Prophase II – Chromosomes condense, centrioles move towards the poles and the nuclear envelope disintegrates.

Metaphase II – Chromosomes align at the equator or the metaphase plate and sister chromatids attach to spindle fibres from opposite poles.

Anaphase II – Centromeres divide and sister chromatids move to opposite poles.

Telophase II – Chromosomes begin to uncoil; nuclear envelope and nucleoli begin to reform.

Cytokinesis – Division of the cytoplasm occurs, resulting in four new daughter cells, each containing haploid number of chromosomes.

Gamete Maturation

In animals and plants, the cells produced by meiosis need to mature before they become functional gametes. In male animals, the four products of meiosis are called spermatids. They grow structures, like tails, and become functional sperm cells. In female animals, the gametes are eggs. For each egg to contain the maximum amount of nutrients, typically only one of the four products of meiosis becomes an egg. The other three cells end up as tiny disposable cells called **polar bodies** (**Figure 1.3.7**). In plants, the products of meiosis reproduce a few times using mitosis as they develop into functional male or female gametes.

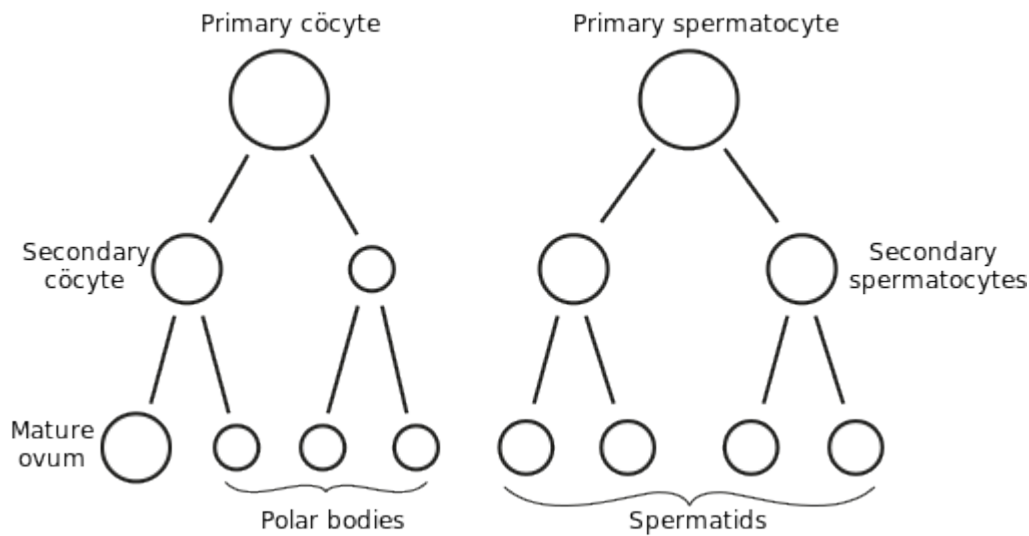

Figure 1.3.7 Polar Body Formation During Gamete Maturation [[Long description](#)]

Media Attributions

- **Figure 1.3.1** [Meiosis main steps](#) by [Peter Coxhead](#), via Wikimedia Commons, [CC0 1.0](#) Universal Public Domain Dedication
- **Figure 1.3.2** [Meiosis Stages](#) by [Ali Zifan](#), via Wikimedia Commons [CC BY-SA 4.0](#)
- **Figure 1.3.3** [Meiotic phenotype of blap75 mutants](#), Chelysheva et al. (2008), PLoS Genetics [CC BY 4.0](#)
- **Figure 1.3.4** [Original](#) by Deyholos (2017), [CC BY-NC 3.0](#), via Open Genetics
- **Figure 1.3.5** [Original](#) by L. Canham (2017), [CC BY-NC 3.0](#), via Open Genetics
- **Figure 1.3.6** [Chromosomal Crossover](#) by [Abbyprovenzano](#), [CC BY-SA 3.0](#), via Wikimedia Commons
- **Figure 1.3.7** [Gray's 7 \(ovum maturation\)](#) by [Fred the Oyster](#), [public domain](#), via Wikimedia Commons

References

- Canham, L. (2017). Figure 7. Diagram of a pair of homologous chromosomes during Prophase I [digital image]. In Locke, J., Harrington, M., Canham, L. and Min Ku Kang (Eds.), *Open Genetics Lectures, Fall 2017* (Chapter 16, p. 6). Dataverse/BCcampus. http://solr.bccampus.ca:8001/bcc/file/7a7b00f9-fb56-4c49-81a9-cfa3ad80e6d8/1/OpenGeneticsLectures_Fall2017.pdf
- Chelysheva, L. et al. (2008) Figure 4. Meiotic phenotype of blap75 mutants [digital image], in The Arabidopsis BLAP75/Rml1 Homologue plays crucial roles in meiotic double-strand break repair. *PLoS Genetics*, 4(12): e1000309. <https://doi.org/10.1371/journal.pgen.1000309>
- Deyholos, M. (2017). Figure 6. Changes in DNA and Chromosome Content During the Cell Cycle [digital image]. In Locke, J., Harrington, M., Canham, L. and Min Ku Kang (Eds.), *Open Genetics Lectures, Fall 2017* (Chapter 16, p. 5). Dataverse/BCcampus. http://solr.bccampus.ca:8001/bcc/file/7a7b00f9-fb56-4c49-81a9-cfa3ad80e6d8/1/OpenGeneticsLectures_Fall2017.pdf
- Fred the Oyster. (2020, October 30). File:Gray's 7 (ovum maturation).svg [digital image]. *Wikimedia Commons*. [https://commons.wikimedia.org/w/index.php?title=File:Gray%27s_7_\(ovum_maturation\).svg&oldid=507847250](https://commons.wikimedia.org/w/index.php?title=File:Gray%27s_7_(ovum_maturation).svg&oldid=507847250)

Provenzano, A. (2013, 23 May). Chromosomal crossover [digital image]. *Wikimedia Commons*.
https://commons.wikimedia.org/wiki/File:Chromosomal_Crossover.svg

Long Descriptions

- **Figure 1.3.1** The stages of meiosis are numbered from 1 to 5. Cells initially contain a diploid number of 4 (2 grey and 2 pink indication homologous pairs). Step 1 shows DNA replication; step 2 shows pairing of homologous chromosomes; step 3 shows crossing over of non-sister chromatids; Step 4 shows production of 2 cells after Telophase I; Step 5 shows production of four daughter cells with haploid number after Telophase 2. [Back to [Figure 1.3.1](#)]
- **Figure 1.3.2** The various stages of meiosis in a cell containing 3 pairs of homologous chromosomes are as follows: Prophase I is shown as chromosomes condense, the nuclear envelope breaks down and crossing over occurs; Metaphase I is shown where pairs of homologous chromosomes line up at the equator of the cell; Anaphase I is shown where chromosomes migrate to opposite poles of the cell; Telophase I and cytokinesis is shown where cytoplasm divides; Prophase II is shown where spindle fibres form; Metaphase II is shown where chromosomes line up at the equator; Anaphase II is shown where centromeres divide and chromatids move to opposite poles of the cell, and finally Telophase II and cytokinesis is shown where nuclear envelope reforms and four daughter cells with a haploid number results. [Back to [Figure 1.3.2](#)]
- **Figure 1.3.3** Eight microscope images, labelled A to H, show the various steps of meiosis in Arabidopsis cells with a haploid number of five. Panels A-C show different stages of prophase I, each with an increasing degree of chromosome condensation. The subsequent phases are metaphase I (D), telophase I (E), metaphase II (F), anaphase II (G), and telophase II (H). [Back to [Figure 1.3.3](#)]
- **Figure 1.3.4** A schematic diagram: DNA, represented by simple lines, outlining the changes in the chromosome number during various stages of the cell cycle, starting with gametes (haploid number), moving through fertilization (diploid number), followed by DNA replication during the S phase (synthesis phase), and showing two possibilities for cell division, with mitosis ending up with two diploid number daughter cells and mitosis ending up with four haploid number cells. [Back to [Figure 1.3.4](#)]
- **Figure 1.3.5** A pair of homologous chromosomes, one coloured green and the other coloured blue, form a synaptonemal complex, and show the crossing over of non-sister chromatids to produce recombinant chromosomes post-crossover. [Back to [Figure 1.3.5](#)]
- **Figure 1.3.6** Three parts: 1) a pair of homologous chromosomes, which have already been duplicated, one coloured pink and the other coloured blue; 2) The two chromosomes associate and cross over non-sister chromatids; 3) There are four resulting chromatids – two are non-recombinant and two are recombinant. [Back to [Figure 1.3.6](#)]
- **Figure 1.3.7** The primary oocyte (one cell) results in the secondary oocyte (two cells) and these form polar bodies (three cells) and a mature ovum (one cell); the primary spermatocyte (one cell) forms the secondary spermatocytes (two cells), and these form the spermatids (four cells). All cells are represented by simple circles. [Back to [Figure 1.3.7](#)]

1.4 One Locus on a Chromosome - Segregation - Monohybrid

Not only did Mendel solve the mystery of inheritance as units (genes), he also invented several testing and analysis techniques still used today. **Classical genetics** is the science of examining biological questions using controlled matings of model organisms. It began with Mendel in 1865, but did not attain widespread usage until Mendel's work was rediscovered in 1903 by four researchers (E. von Tschermak, H. de Vries, C. Correns, and W. J. Spillman). Then Thomas Morgan began working with fruit flies in 1908 and used this work. Later, starting with Watson and Crick's structure of DNA in 1953, classical genetics was joined by **molecular genetics**, the science of solving biological problems using DNA, RNA, and proteins. The genetics of **DNA cloning** began in 1970 with the discovery of restriction enzymes and plasmids as cloning vectors.

Knowing what we now know about the process of meiosis, we can better understand the mechanisms underlying Mendel's First Law. The Law of Segregation states that every individual contains a pair of alleles for each gene, which segregate during the formation of gametes, and so for every gene pair, each parent passes on a random allele to its offspring. The series of experiments that led to the formulation of Mendel's First Law were based on the process of **Monohybrid crosses**, which we will discuss.

Take a look at the following video on the *Law of Segregation (Mendel's First Law of Inheritance)* by FL-Genetics/03 (2018).

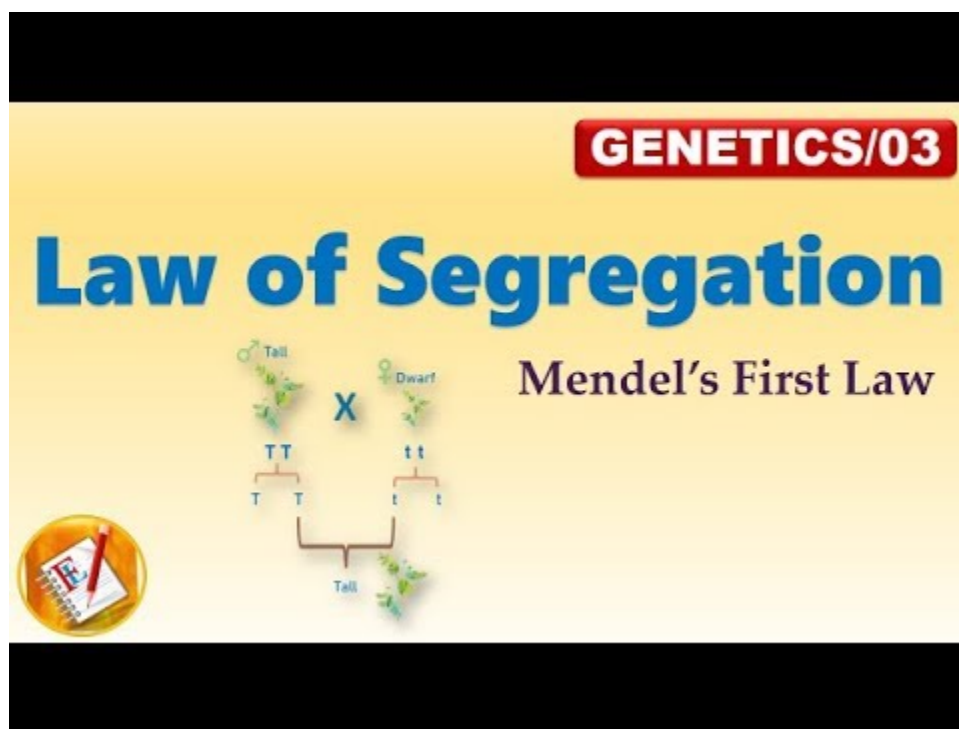

A YouTube element has been excluded from this version of the text. You can view it online here:

<https://opengenetics.pressbooks.tru.ca/?p=224>

Terminology

A specific position, region, or segment along a chromosome is called a **locus**. Each gene occupies a specific locus (so the terms locus and gene are often used interchangeably). Each locus will have an allelic form (allele). The complete set of alleles (at all loci of interest) in an individual is its **genotype**. Typically, when writing out a genotype, only the alleles at the locus (loci) of interest are considered – all the others are present and assumed to be wild type but are normally not written in the genotype. The observable or detectable effect of these alleles on the structure or function of that individual is called its **phenotype**. The phenotype studied in any particular genetic experiment may range from simple, visible traits such as hair color, to more complex phenotypes including disease susceptibility or behavior. If two alleles are present in an individual, then various interactions between them may influence their expression in the phenotype.

True-Breeding Lines

Geneticists make use of **true-breeding lines** just as Mendel did (**Figure 14.1**). These are in-bred populations of plants or animals in which all parents and their offspring (over many generations) have the same phenotypes with respect to a particular trait. True-breeding lines are useful, because they are typically assumed to be homozygous for the alleles that affect the trait of interest.

When two individuals that are homozygous for the same alleles are crossed, all of their offspring will all also be homozygous. The continuation of such crosses constitutes a true breeding line or strain. A large variety of different strains, each with a different, true breeding character, can be collected and maintained for genetic research.

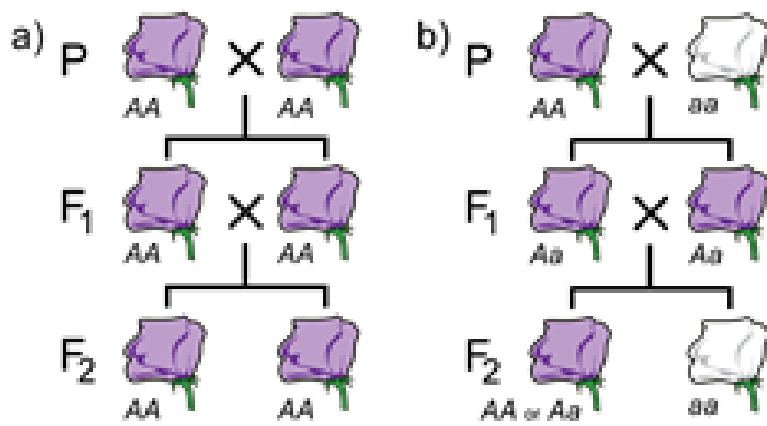

Figure 1.4.1: (a) A True-Breeding Line (b) A Monohybrid Cross Produced by Mating Two Different Pure-Breeding Lines. [[Long description](#)]

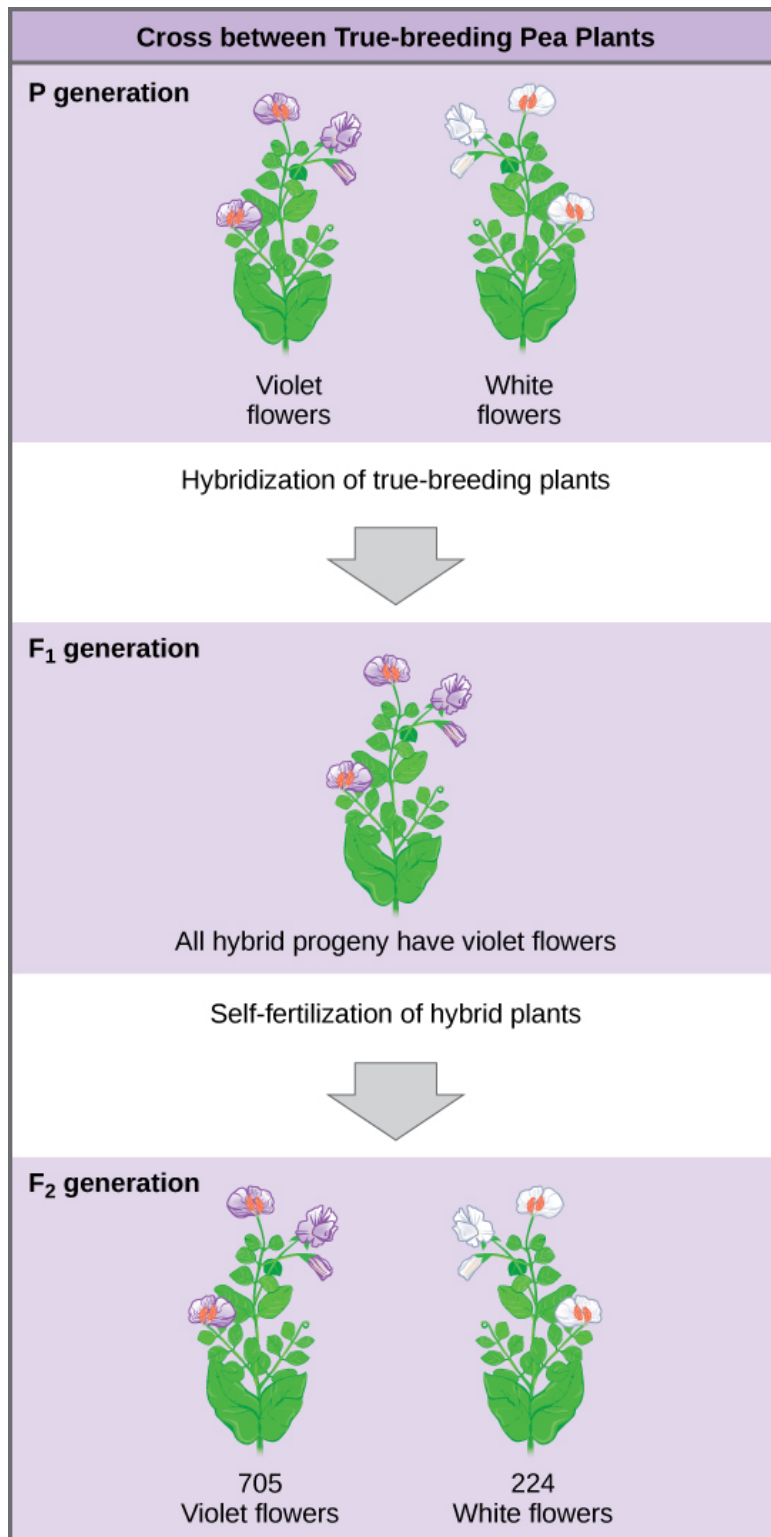

Figure 1.4.2 Experimental Cross Between Two True Breeding Plants [[Long description](#)]

Monohybrid Crosses

A **monohybrid cross** is one in which both parents are heterozygous (or a hybrid) for a single (mono) trait. The trait might be petal colour in pea plants (**Figures 1.4.1 and 1.4.2**). Recall that the generations in a cross are named P (parental), F₁ (first filial), F₂ (second filial), and so on.

By using monohybrid crosses, Mendel discovered that genes were discrete units that separated in the creation of offspring. Previous ideas of blending inheritance would mean that a cross between a white flower and a purple flower would create a 'blended' phenotype. Instead what Mendel saw was distinct parental colours in the hybrids, that when crossed would produce in specific ratios the purple and white seen in the parents. These traits were not blended when the true-breeding lines were crossed, but instead those parental alleles were carried on through the offspring. Through the monohybrid cross he was able to discern the **dominant** and **recessive** alleles of each gene he studied in the pea plants. In further crosses (F₃, F₄, etc.), these traits were continuously transmitted and not lost, though they may be hidden as seen in the F₁ generation. **Figure 1.4.3** demonstrates a monohybrid cross and progeny produced.

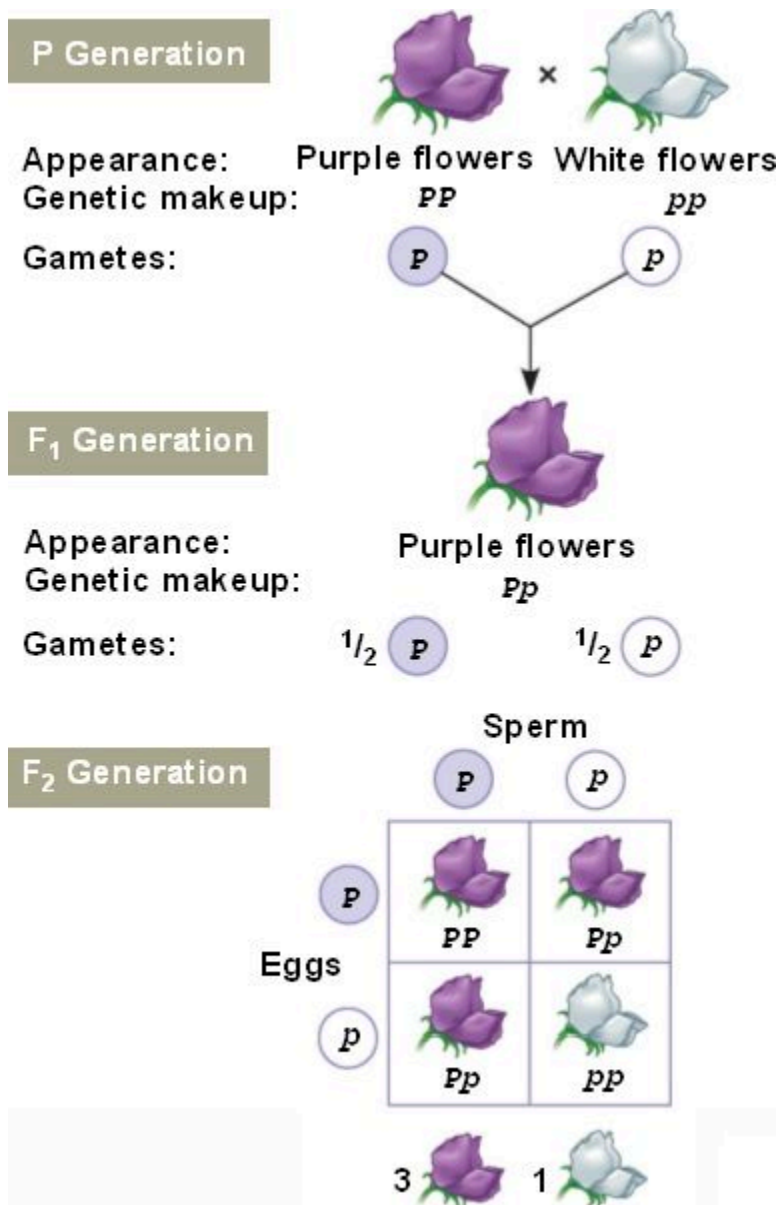

Figure 1.4.3 A Monohybrid Cross Showing Parental, F₁ and F₂ Generations [[Long description](#)]

Media Attributions

- **Figure 1.4.1** [Original](#) by Deyholos (2017), [CC BY-NC 3.0](#), Open Genetics Lectures
- **Figure 1.4.2** [Figure 12.01.02](#) by [CNX OpenStax Biology](#) (2016), [CC BY 4.0](#), via Wikimedia Commons
- **Figure 1.4.3** [Law of Segregation](#) by [Ashinkaaa](#), [CC BY-SA 4.0](#), via Wikimedia Commons

References

Deyholos, M. (2017). Figure 8. (a) A true-breeding line (b) A monohybrid cross produced...[digital file]. In Locke, J., Harrington, M., Canham, L. and Min Ku Kang (Eds.), *Open Genetics Lectures, Fall 2017* (Chapter 16, p. 8). Dataverse/BCcampus. http://solr.bccampus.ca:8001/bcc/file/7a7b00f9-fb56-4c49-81a9-cfa3ad80e6d8/1/OpenGeneticsLectures_Fall2017.pdf

Frank Lectures. (2018, May 12). Law of segregation (Mendel's First Law of Inheritance) (FL-Genetics/03) [Video file]. YouTube. <https://www.youtube.com/watch?v=4tVgmYIHPVM>

Rye, C., Wise, R., Jurukovski, V., DeSaix, J., Choi, J. & Avissar, Y. (2016, October 21). Figure 12.3. In one of his experiments... [digital file]. CNX OpenStax Biology (Chapter 12). <https://openstax.org/books/biology/pages/12-1-mendels-experiments-and-the-laws-of-probability>

Long Descriptions

- **Figure 1.4.1** Two parts, showing purple and white flowers. The resulting F1 and F2 generations after breeding two pure line purple flowers (genotype AA) are: all offspring in the F1 and F2 contain purple flowers (all have genotype AA). The resulting F1 and F2 generations after breeding a pure line purple flower (AA) and a pure line white flower (aa) are: the F1 contains all purple flowers, but are heterozygous (Aa) and the F2 contains both purple (homozygous and heterozygous) as well as white flowers. [Back to [Figure 1.4.1](#)]
- **Figure 1.4.2** Plants containing either white or violet coloured flowers: Parental (P) and F1 and F2 generations, result from the breeding of a pure line violet flowered plant and a pure line white flowered plant. The F1 generation are hybrids, all containing violet flowered plants and the F2 generation produce a mixture of violet flowered plants and white flowered plants in a 3:1 ratio. [Back to [Figure 1.4.2](#)]
- **Figure 1.4.3** The parental pure breeding lines are represented by purple flowers of genotype PP and white flowers of genotype pp. Gamete formation is shown to produce the F1 generation, all of which are purple flowers of the heterozygous genotype, Pp. A punnett square outlines the production of the F2 generation from self-fertilization of the F1; three purple flowers are produced, with one white. The typical monohybrid ratio of 3:1 in the F2 generation is shown. [Back to [Figure 1.4.3](#)]

1.5 Punnett Squares - 3:1 Ratio

The specific ratios seen in the monohybrid cross can be described using a **Punnett square**, named after R.C. Punnett who devised this approach.

Given the genotypes of any two parents, we can predict all of the possible genotypes of the offspring. Furthermore, if we also know the dominance relationships for all alleles, we can predict the phenotypes of the offspring. This provides a convenient method for calculating the expected genotypic and phenotypic ratios from a cross.

A Punnett square is a matrix in which all of the possible gametes produced by one parent are listed along one axis, and the gametes from the other parent are listed along the other axis. Each possible combination of gametes is listed at the intersection of each row and column, since we know through the process of meiosis that the alleles on each chromosome separate to form the gametes.

The F_1 cross would be drawn as in **Figure 1.5.1**. As you can see, in a Monohybrid cross, the offspring ratios will be 3:1 of dominant phenotype (purple): recessive phenotype (white). Punnett squares can also be used to calculate the frequency of offspring. The frequency of each offspring is the frequency of the male gametes multiplied by the frequency of the female gamete.



	A	a
	A	a
	AA	Aa
	Aa	aa

Figure 1.5.1 A Punnett Square Showing a Monohybrid Cross. The purple boxes represent the purple colour of the dominant (A) allele, while the white box represents the recessive (aa) allele homozygote. [[Long description](#)]

Generation 1 Cross:

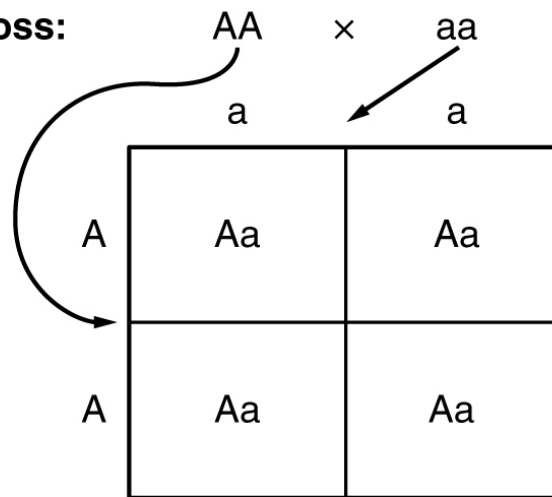

Generation 2:
100% of offspring
are AA (dominant)

Generation 2 Cross:

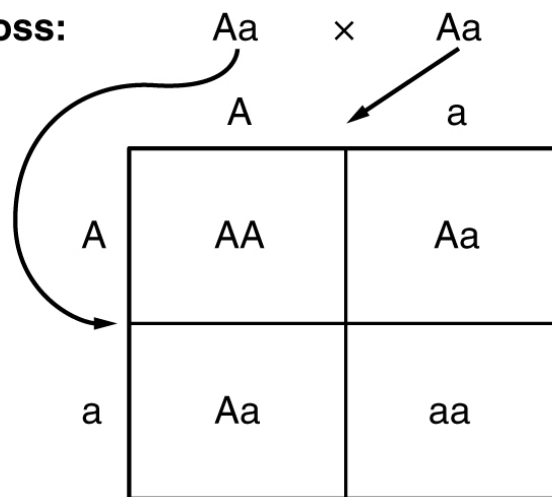

Generation 3:
75% AA or Aa
(dominant)
25% aa recessive

Figure 1.5.2 General Example of a Monohybrid Cross Showing Expected Progeny and Ratios in the F1 and F2 Generations. [[Long description](#)]

View the video, *Monohybrid Cross Examples - GCSE Biology (9-10)*, by Mr Exham Biology (2018), and watch for some worked examples on Monohybrid crosses.

MONOHYBRID CROSS

for brown eyes, what percentage of their children will have blue eyes?

Parents Phenotype: Brown x Brown

Parents Genotype: Bb x Bb

Parents gametes: B b B b

Punnett Square:

	B	b
B	BB	Bb
b	Bb	bb

The allele for brown is dominant and blue is recessive.



MrExham.com • Making Sense Of Biology

KS4 • IGCSE • GCSE • MYP • HIGH SCHOOL BIOLOGY

A YouTube element has been excluded from this version of the text. You can view it online here:

<https://opengenetics.pressbooks.tru.ca/?p=228>

Media Attributions

- **Figure 1.5.1** [Original](#) by L. Canham (2017), [CC BY-NC 3.0](#), via Online Open Genetics
- **Figure 1.5.2** [2924 Mendelian Pea Plant Cross](#), by Betts et al (2013), [OpenStax College](#), [CC BY 3.0](#), via Wikimedia Commons

References

- Betts, J. G., Young, K. A., Wise, J. A., Johnson, E., Poe, B., Kruse, D. H., Korol, O., Johnson, J. E., Womble, M., & DeSaix, P. (2013, Apr 25). Figure 28.25 Random segregation [digital image]. *Anatomy and Physiology*. CNX OpenStax. <https://openstax.org/books/anatomy-and-physiology/pages/28-7-patterns-of-inheritance>
- Canham, L. (2017). Figure 9. A Punnett square showing a monohybrid cross [diagram]. In Locke, J., Harrington, M., Canham, L. and Min Ku Kang (Eds.), *Open Genetics Lectures, Fall 2017* (Chapter 16, p. 9). Dataverse/ BCcampus. http://solr.bccampus.ca:8001/bcc/file/7a7b00f9-fb56-4c49-81a9-cfa3ad80e6d8/1/OpenGeneticsLectures_Fall2017.pdf
- Mr Exham Biology. (2018, Dec 31). Monohybrid cross examples – GCSE Biology (9-10) [Video file]. YouTube. <https://www.youtube.com/watch?v=Xld3-Fr9oUU>

Long Descriptions

- **Figure 1.5.1** A simple Punnett square, represented by a square divided into nine smaller squares: The top row shows the alleles or gametes (A and a) derived from the female parent, and the left column shows the alleles or gametes derived from the male parent (A and a). The resulting offspring are shown with their accompanying genotypes of AA: Aa: aa in the ratio 1:2:1. [Back to [Figure 1.5.1](#)]
- **Figure 1.5.2** Two parts: 1) A simple Punnett square consisting of four squares shows the production of offspring from the mating of a homozygous dominant parent and a homozygous recessive parent to produce 100% heterozygous progeny; 2) A Punnett square consisting of four squares shows the production of offspring from the mating of two heterozygous parents to produce the typical 3:1 monohybrid ratio of dominant to recessive phenotypes. [Back to [Figure 1.5.2](#)]

1.6 Single Locus Test Crosses

Knowing the genotypes of an individual is an important part of a genetic experiment. However, genotypes cannot be observed directly; they must be inferred based on phenotypes. Because of dominance, it is often not possible to distinguish between a heterozygote and a homozygote based on phenotype alone (e.g., see the purple-flowered F_2 plants). To determine the genotype of a specific individual, a **test cross** can be performed in which the individual with an unknown genotype is crossed with an individual that is homozygous recessive for all of the loci being tested.

For example, if you were given a pea plant with purple flowers it might be a homozygote (AA) or a heterozygote (Aa). You could cross this purple-flowered plant to a white-flowered plant as a **tester**, since you know the genotype of the tester is aa . Depending on the genotype of the purple-flowered parent (**Figure 1.6.1**), you will observe one of two phenotypic ratios in the F_1 generation. If the purple-flowered parent was a homozygote AA , all of the F_1 progeny will be purple. If the purple-flowered parent was a heterozygote Aa , the F_1 progeny should segregate purple-flowered and white-flowered plants in a 1:1 ratio.

$\begin{array}{c} \text{♀} \\ \diagdown \\ \text{♂} \end{array}$	A	A
a	Aa	Aa
a	Aa	Aa

$\begin{array}{c} \text{♀} \\ \diagdown \\ \text{♂} \end{array}$	A	a
a	Aa	aa
a	Aa	aa

Figure 1.6.1 Punnett Squares Showing the Two Possible Outcomes of a Single Locus Test Cross [[Long description](#)]

Take a look at the video, *Testcross Explained*, by Nicole Lantz (2020) on YouTube, which outlines monohybrid test crosses.

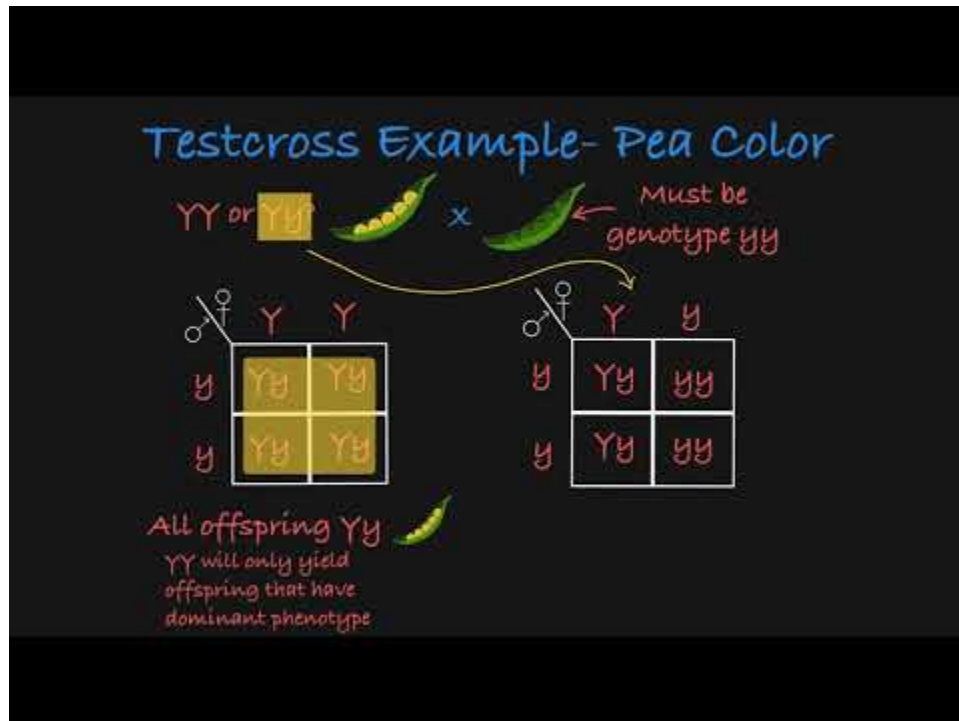

A YouTube element has been excluded from this version of the text. You can view it online here:

<https://opengenetics.pressbooks.tru.ca/?p=234>

Media Attribution

- **Figure 1.6.1** [Original](#) by L. Canham (2017), [CC BY-NC 3.0](#), Online Open Genetics

References

- Canham, L. (2017). Figure 10. Punnett squares showing the two possible outcomes of a single locus test cross [diagram]. In Locke, J., Harrington, M., Canham, L. and Min Ku Kang (Eds.), *Open Genetics Lectures, Fall 2017* (Chapter 16, p. 9). Dataverse/ BCcampus. http://solr.bccampus.ca:8001/bcc/file/7a7b00f9-fb56-4c49-81a9-cfa3ad80e6d8/1/OpenGeneticsLectures_Fall2017.pdf
- Nicole Lantz. (2020, April 14). Testcross explained [Video file]. YouTube. https://www.youtube.com/watch?v=8y_SLtToUOA&feature=youtu.be.

Long Description

- **Figure 1.6.1** Two Punnett squares are shown, each as a square containing nine smaller squares. One Punnett square

shows the production of alleles from a homozygous dominant parent (AA) and a homozygous recessive parent (aa), to produce four offspring which are all heterozygous (Aa). The other Punnett square shows the production of alleles from a heterozygous parent (Aa) and a homozygous recessive parent (aa) to produce offspring in a 1:1 ratio between heterozygous (Aa) and homozygous recessive (aa). [[Back to Figure 1.6.1](#)]

Chapter 1 Summary

The topics covered in this chapter can be summarized as follows:

- Mendel demonstrated that heredity involved discrete, heritable factors that affected specific traits.
- A gene can be defined operationally as a unit of inheritance.
- Homologous chromosomes contain the same series of genes along their length, but not necessarily the same alleles. Sister chromatids initially contain the same alleles.
- Homologous chromosomes pair (synapse) with each other during meiosis, but not mitosis.
- A diploid organism can have up to two different alleles at a single locus. The alleles segregate equally between gametes during meiosis.
- Phenotype depends on the alleles that are present, their dominance relationships, and sometimes interactions with the environment and other factors.
- Classical geneticists make use of true breeding lines, monohybrid crosses, Punnett squares, test crosses, and reciprocal crosses.

Key Terms in Chapter 1

The following video, *Genetics & Cell Division Keyword Definitions | Genetics | Biology*, by FuseSchool – Global Education (2016) summarizes some key terms and definitions commonly used in genetics.



A YouTube element has been excluded from this version of the text. You can view it online here:

<https://opengenetics.pressbooks.tru.ca/?p=246>

Key Terms – Mendel's First Law and Meiosis

- alleles
- Anaphase I
- Anaphase II
- bivalent
- blending inheritance
- chiasma / chiasmata
- classical genetics
- crossing over
- diakinesis
- diplotene
- DNA cloning
- dominant
- equational
- gametes
- genotype
- Gregor Mendel
- interkinesis
- leptotene
- locus
- meiocytes
- Meiosis I
- Meiosis II
- Mendel's First Law
- Metaphase I
- Metaphase II
- molecular genetics
- monohybrid cross
- pachytene

- pair up
- particulate inheritance
- phenotype
- polar bodies
- Prophase II
- Punnett square
- recessive
- reductional
- synapse
- synaptonemal complex
- Telophase I
- Telophase II
- test cross
- tester
- The Law of Equal Segregation
- true-breeding lines
- zygotene

Reference

FuseSchool – Global Education. (2016, September 12). Genetics & cell division keyword definitions | genetics | biology | FuseSchool [Video file]. YouTube. <https://www.youtube.com/watch?v=4oQAMpLxo5k&feature=youtu.be>.

Chapter 1 Study Questions

1. How would the results of the cross in [Figure 1.1.5](#) have been different if heredity worked through blending inheritance rather than particulate inheritance?
2. What is the maximum number of alleles at a given autosomal locus in a normal gamete from a diploid individual? In the whole population of a species?
3. Wiry hair (W) is dominant to smooth hair (w) in dogs.
 - a. If you cross a homozygous, wiry-haired dog with a smooth-haired dog, what will be the genotype and phenotype of the F1 generation?
 - b. If two dogs from the F1 generation mated, what would be the most likely ratio of hair phenotypes among their progeny?
 - c. When two wiry-haired Ww dogs actually mated, they had a litter of three puppies, which all had smooth hair. How do you explain this observation?
 - d. Someone left a wiry-haired dog on your doorstep. Without extracting DNA, what would be the easiest way to determine the genotype of this dog?
 - e. Based on the information provided in Question 1, can you tell which, if either, of the alleles is wild-type?
4. An important part of Mendel's experiments was the use of homozygous lines as parents for his crosses. How did he know they were homozygous, and why was the use of the lines important?
5. Does equal segregation of alleles into daughter cells happen during mitosis, meiosis, or both?

Chapter 1 Answers

1. If genetic factors blended together like paint then they could not be separated again. The white-flowered phenotype would therefore not reappear in the F₂ generation, and all the flowers would be purple or maybe light purple, not white.
2. There is a maximum of two alleles for a normal autosomal locus from a diploid individual. In the whole population, there can be essentially an unlimited number of different alleles; the limit being determined by the population size.
3.
 - a. In the F₁ generation, the genotype of all individuals will be Ww and all of the dogs will have wiry hair.
 - b. In the F₂ generation, there would be an expected 3:1 ratio of wiry-haired to smooth-haired dogs.
 - c. Although it is expected that only one out of every four dogs in the F₂ generation would have smooth hair, large deviations from this ratio are possible, especially with small sample sizes. These deviations are due to the random nature in which gametes combine to produce offspring. Another example of this would be the fairly common observation that in some human families, all of the offspring are either girls, or boys, even though the expected ratio of the sexes is essentially 1:1.
 - d. You could do a test cross, i.e., cross the wiry-haired dog to a homozygous recessive dog (ww). Based on the phenotypes among the offspring, you might be able to infer the genotype of the wiry-haired parent.
 - e. From the information provided, we cannot be certain which, if either, allele is wild-type. Generally, dominant alleles are wild-type, and abnormal or mutant alleles are recessive.
4. Even before the idea of a homozygous genotype had really been formulated, Mendel was still able to assume that he was working with parental lines that contained the genetic material for only one variant of a trait (e.g., EITHER green seeds or yellow seeds), because these lines were pure-breeding. Pure-breeding means that the phenotype doesn't change over several generations of self-pollination. If the parental lines had not been pure-breeding, it would have been very hard to make certain key inferences, such as that the F₁ generation could contain the genetic information for two variants of a trait, although only one variant was expressed. This inference led eventually to Mendel's First Law.
5. Equal segregation of alleles occurs only in meiosis. Although mitosis does produce daughter cells that are genetically equal, there is no segregation (i.e., separation) of alleles during mitosis; each daughter cell contains both of the alleles that were originally present in the parent cell.

CHAPTER 2 - MENDEL'S SECOND LAW: INDEPENDENT ASSORTMENT

2.1 Introduction

Learning Objectives

- Describe Mendel's Principle of Independent Assortment.
- Analyze parental and offspring phenotypes to determine patterns of inheritance for two traits.
- Apply probability and branch diagrams to determine genotypic and phenotypic ratios in dihybrid and trihybrid crosses.
- Apply a test cross to identify genotypes in individuals expressing two dominant traits.
- Apply proper use of modern genetic terminology.
- Outline the concept of Linkage (resulting in distortion of the ratios expected from independent assortment).

Having determined from monohybrid crosses that genes are inherited according to the Law of Segregation, Mendel looked at the simultaneous inheritance of two or more unrelated traits. He considered how two pairs of alleles would segregate into a dihybrid individual (i.e., a plant that is heterozygous for two genes). Mendel's Law of Independent Assortment states that during gamete formation, alleles at separate loci segregate independently, and this produces characteristic genotypic and phenotypic ratios. As such, the principles of genetic analysis that we have described for a single locus in [Chapter 1](#) will be extended to the study of alleles at two loci in this chapter. The analysis of two loci in the same cross provides information for genetic mapping and testing gene interactions.

Take a look at the following YouTube video, *Law of Independent Assortment*, by AK Lecture Series (2015) on YouTube.

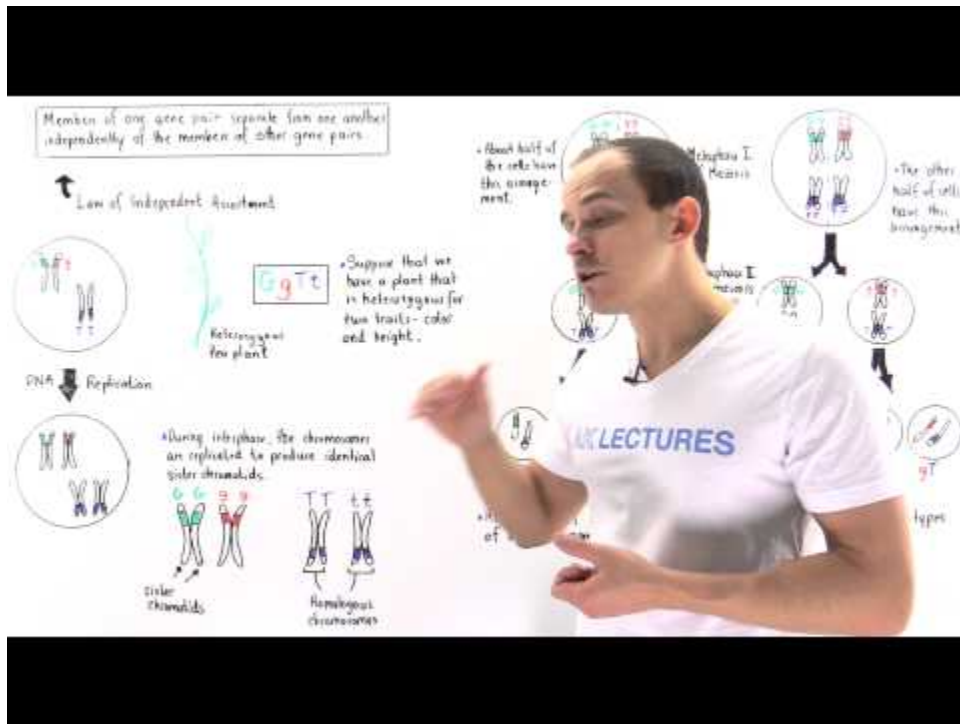

A YouTube element has been excluded from this version of the text. You can view it online here:

<https://opengenetics.pressbooks.tru.ca/?p=296>

Before Mendel's 1865 publication, **blended inheritance** was the accepted model to explain the transmission of traits. It was Mendel's work that established that **heritable traits** were controlled by discrete factors, which we now call alleles, in a **particulate inheritance** model. At the time, it was an important question as to whether heritable traits, controlled by discrete factors, were inherited independently of each other? To answer this, Mendel took two apparently unrelated traits, such as seed shape and seed colour, and studied their inheritance together in one individual. For example, he studied two variants of each trait: seed colour was either green or yellow, and seed shape was either round or wrinkled. (He studied seven traits in all, each on a different chromosome.) When either of these traits was studied individually, the phenotypes segregated in the classical 3:1 ratio among the progeny of a monohybrid cross (**Figure 2.1.1**), with $\frac{3}{4}$ of the seeds green and $\frac{1}{4}$ yellow in one cross, and $\frac{3}{4}$ round and $\frac{1}{4}$ wrinkled in the other cross. Would this be true when both hybrids were in the same individual?

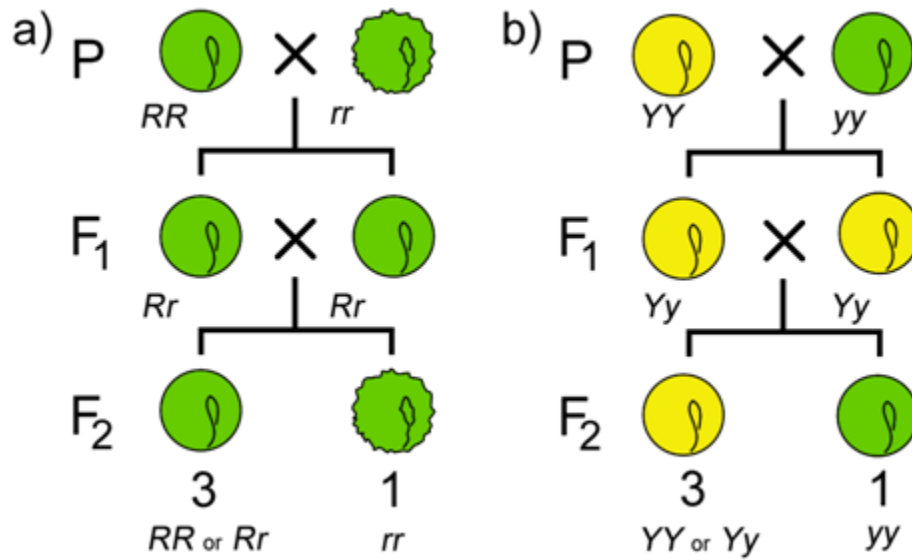

Figure 2.1.1 Monohybrid Crosses Involving Two Distinct Traits in Peas. a) is R/r and b) is Y/y. [\[Long description\]](#)

Like in the previous [Chapter 1](#), we will first walk through how a dihybrid cross works on at the DNA level, and then we will explain the results that Mendel saw that led him to his law, the Law of Independent Assortment.

When dealing with alleles at two different loci, we have to use nomenclature that makes the arrangement clear. There are three possible arrangements: Both loci are on the same chromosome (AB/ab), different chromosomes (A/a; B/b) as shown for example in **Figure 2.2**, or unknown (AaBb).

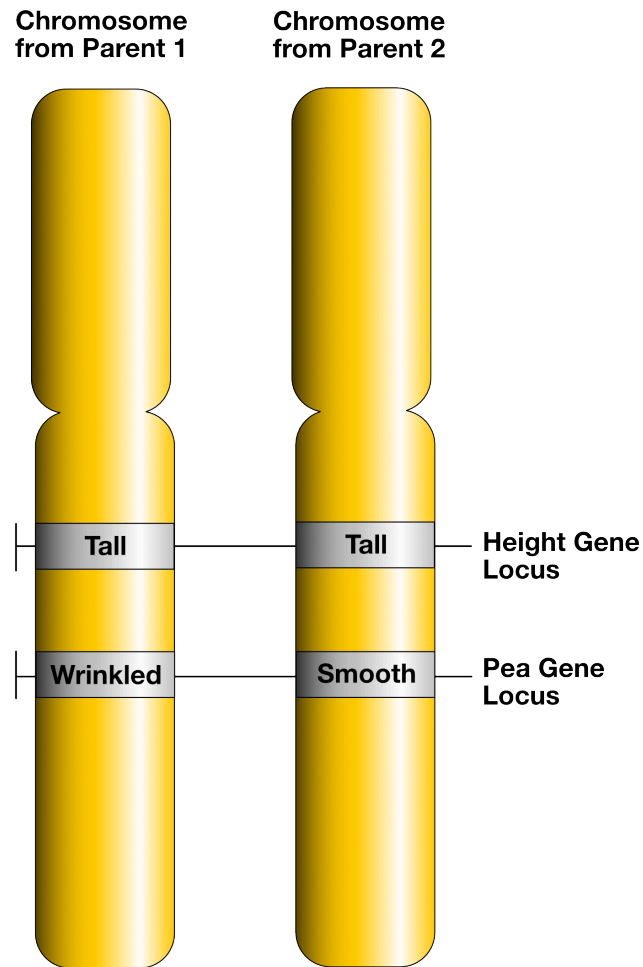

Figure 2.1.2 Gene Loci on Two Different Chromosomes [[Long description](#)]

Media Attributions

- **Figure 2.1.1** [Original](#) by Deyholos (2017), [CC BY-NC 3.0](#), via Biology Libretexts
- **Figure 2.1.2** [Gene Loci and Alleles](#) by Keith Chan, [CC BY-SA 4.0](#), via Wikimedia Commons

References

AK Lectures. (2015, January 2). Law of independent assortment [Video file]. YouTube. <https://www.youtube.com/watch?v=VjPjyLwcYYQ>

Deyholos, M. (2017). Figure 2. Monohybrid crosses involving two distinct traits in peas [digital image]. In Locke, J., Harrington, M., Canham, L. and Min Ku Kang (Eds.), *Open Genetics Lectures, Fall 2017* (Chapter 17, p. 1). Dataverse/

BCcampus. http://solr.bccampus.ca:8001/bcc/file/7a7b00f9-fb56-4c49-81a9-cfa3ad80e6d8/1/OpenGeneticsLectures_Fall2017.pdf

Keith Chan. (2015, July 23). Gene Loci and Alleles [digital image]. Wikimedia Commons. https://commons.wikimedia.org/wiki/File:Gene_Loci_and_Alleles.png

Long Descriptions

- **Figure 2.1.1** Two sets of genetic crosses, using green- and yellow-colored seeds. The first genetic cross shows the production of F1 and F2 generations from parental pure lines. In this cross, one pure breeding round seeded parent is crossed with one pure breeding wrinkled seeded parent. The F1 generation is produced, and all have round seeds and are heterozygous for this trait. The subsequent F2 generation produces round and wrinkled seeds in the typical 3:1 monohybrid ratio. The other genetic cross shows the same type of cross, except this time for yellow and green seeds, with yellow as the dominant trait, and green as the recessive trait. [Back to [Figure 2.1.1](#)]
- **Figure 2.1.2** Two homologous chromosomes colored in yellow with two gene loci shown on these chromosomes – one for plant height and the other for pea shape. Both chromosomes contain the allele for tall height, but the first has the allele for wrinkled seeds, and the other has the allele for round seeds. [Back to [Figure 2.1.2](#)]

2.2 Two Loci on Different Chromosomes

The separation of gametes through the process of meiosis has already been introduced. But what does that mean when you are taking multiple, different genes (or loci) into account?

Remember the main stages of meiosis. The homologous pairs align during Metaphase I, and complete one round of cell division. Then, during Metaphase II, the replicated chromosomes in those two cells align individually and the sister chromatid separate. So when complete, you have two daughter cells. Let's say one chromosome has gene A on it, and another chromosome has gene B on it, and the individual is heterozygous at each gene (a.k.a. has the genotype $A/a ; B/b$). There are a variety of ways that the homologous pairs can align themselves during metaphase I. The orientation of that alignment will affect the alleles each gamete receives at the end of telophase II (**Figure 2.2.1**).

Because the alignment at Metaphase I is always random, you will see a random, equal distribution of alleles in all the gametes produced. This means that one allele doesn't affect the distribution of another allele, or in other words, each allele assort independently (**Independent Assortment**).

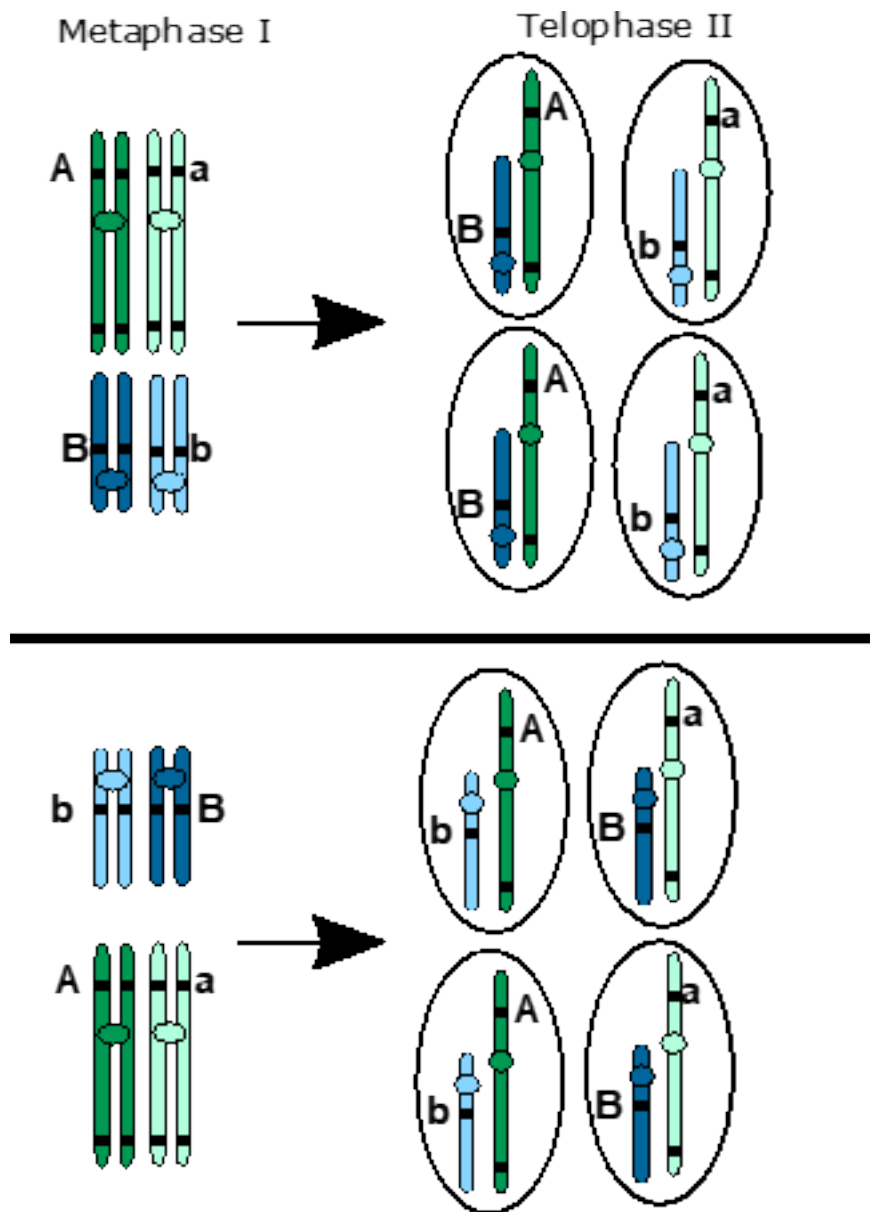

Figure 2.2.1 Independent Assortment as Seen on Two Different Chromosomes. Gene A is found on the short chromosome and Gene B is found on the long chromosome, and both genes are heterozygotes for the dominant (A and B) and recessive (a and b) alleles. The orientation that the chromosomes align themselves during metaphase I affects the alleles found in the 4 gametes produced after telophase II. These are just two of many orientations the chromosomes can arrange themselves in at metaphase I. The full stages of meiosis were removed for simplicity. Refer to [Chapter 1](#) to understand the divisions that lead to the 4 gametes seen in Telophase II. [[Long description](#)]

Media Attribution

- **Figure 2.2.1** [Original](#) by L. Canham (2017), [CC BY-NC 3.0](#), via Open Genetics Lectures

Reference

Canham, L. (2017). Figure 3. Independent assortment as seen on two different chromosomes [digital image]. In Locke, J., Harrington, M., Canham, L. and Min Ku Kang (Eds.), *Open Genetics Lectures, Fall 2017* (Chapter 17, p. 2). Dataverse/BCcampus. http://solr.bccampus.ca:8001/bcc/file/7a7b00f9-fb56-4c49-81a9-cfa3ad80e6d8/1/OpenGeneticsLectures_Fall2017.pdf

Long Description

- **Figure 2.2.1** Independent assortment is shown with two pairs of homologous chromosomes to demonstrate: one pair is colored in two shades of green and the other pair is colored in two shades of blue. One orientation of the two pairs is shown during Metaphase I, and the resulting gametes after Telophase II. A different orientation of the two pairs of homologous chromosomes is also shown, with resulting gametes, and the differences in gamete composition also exemplified depending on the independent assortment of chromosomes during Metaphase I of meiosis. [Back to [Figure 2.2.1](#)]

2.3 Two Loci on One Chromosome

Based on the description in the last section, it would be expected that if the genes were on the same chromosome the alleles would travel together through meiosis (**Figure 2.3.1** top). However, when tested this is not always the case. The recombination of alleles can be explained through the phenomenon of **crossing over**, which occurs during prophase I.

Crossing over is an exchange between non-sister chromatids that can occur at any position along the entire chromosome. If the two loci that are being considered are sufficiently separated from each other on the chromosome, crossover events can occur between the two loci.

This coupled with the random orientation that the chromosomes align during metaphase I, will allow the other combination of alleles in the gametes (**Figure 2.3.1** bottom).

While not shown in **Figure 2.3.1**, if the two loci are very far apart, multiple crossover events can also take place, further increasing the shuffling of alleles.

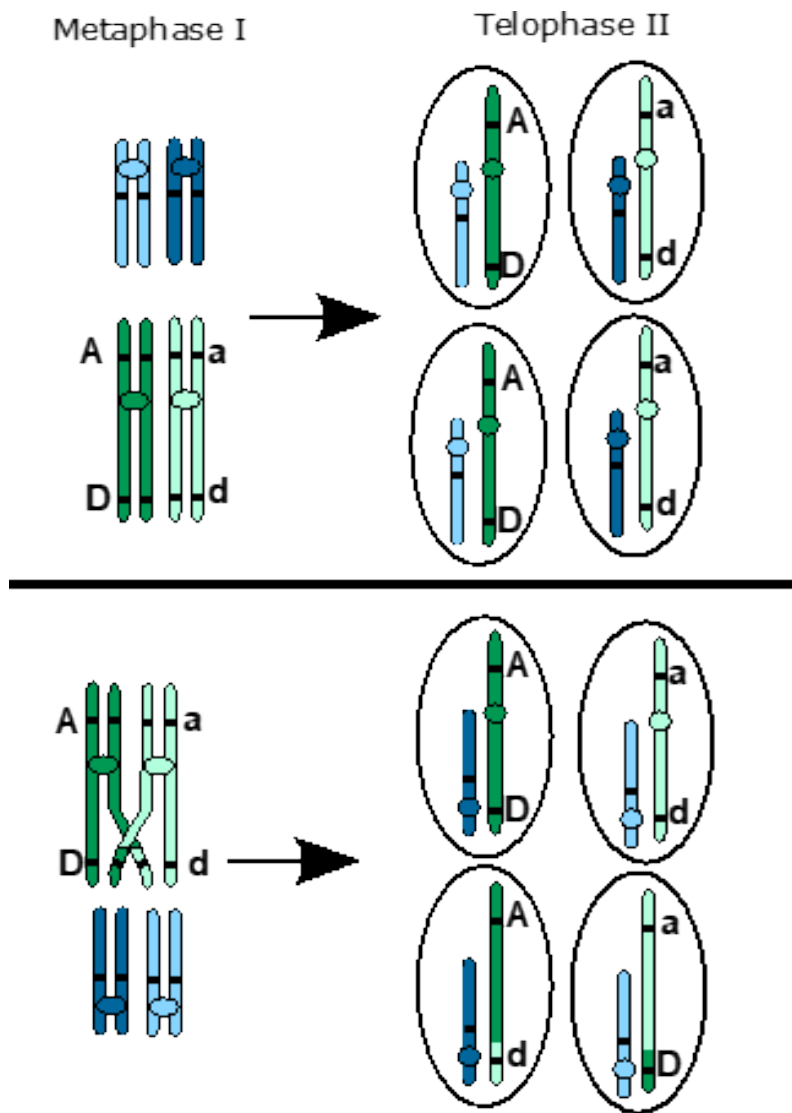

Figure 2.3.1 Independent Assortment as Seen on the Same Chromosome. On the top is an example of what would happen if crossovers do not occur. The dominant alleles of gene A and gene D would travel together, not leading to independent assortment. Crossovers do occur in most situations though, like in the bottom half of the figure. If a crossover occurs between the two genes, then the alleles will transfer to the other non-sister chromatid, thus rearranging alleles. This allows for independent assortment, despite being on the same chromosome. This is just one of the many arrangements or crossover events that could occur during meiosis, with every meocyte arranging themselves differently with different crossovers. [[Long description](#)]

The farther apart on the chromosome the more crossover events (**Figure 2.3.2**) will take place between the two loci. Ultimately, this will result in similar allele combinations to those observed in independent assortment shown above, even if they are on the same chromosome.

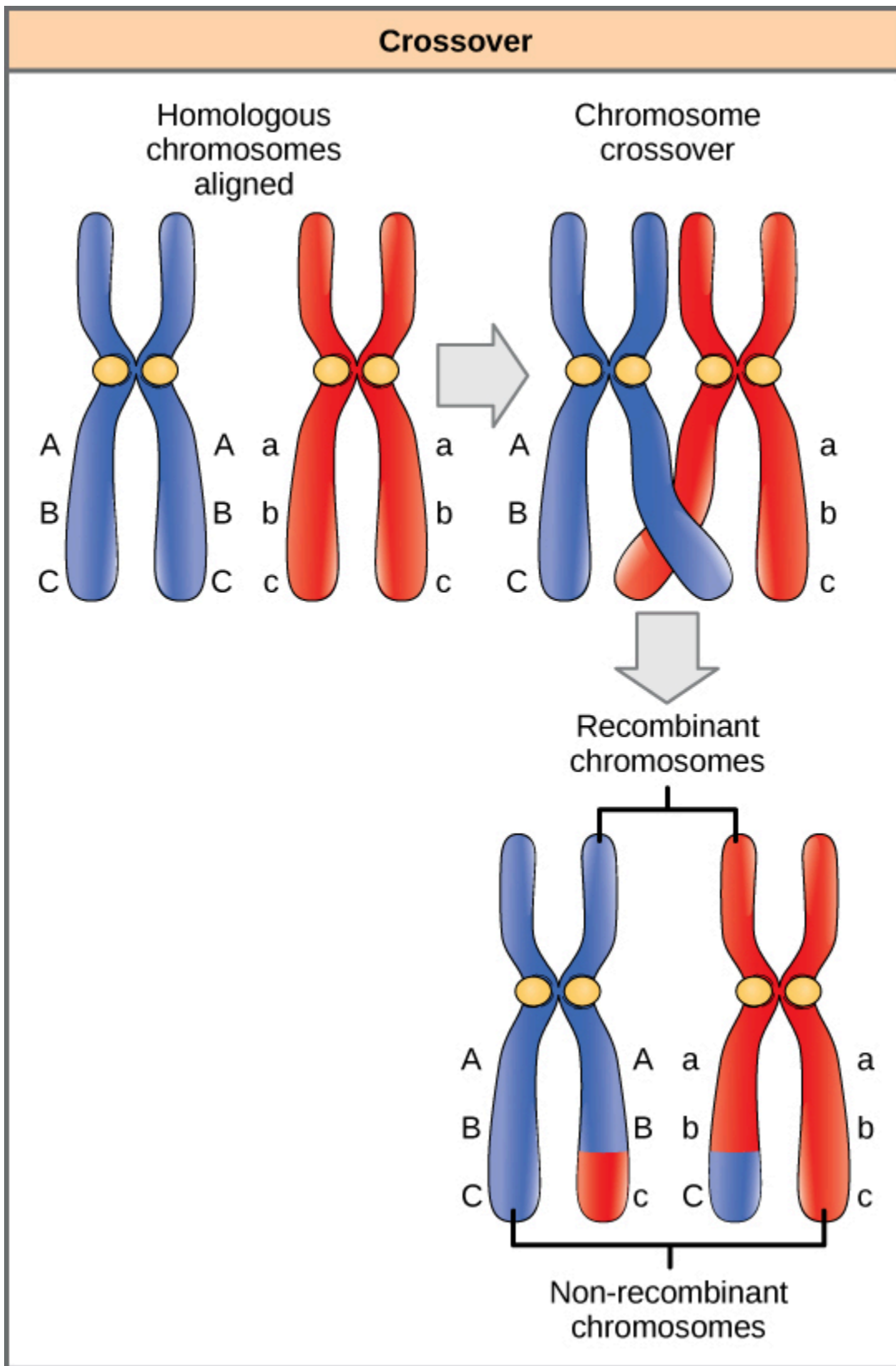

Figure 2.3.2 Crossover of Genetic Material During Prophase I of Meiosis [[Long description](#)]

If the loci are very close together on the same chromosome, fewer crossovers are likely occur between them. We will not discuss this situation in here, but will do so later on.

Media Attributions

- **Figure 2.3.1 Original** by L. Canham (2017), [CC BY-NC 3.0](#), Open Genetics Lectures
- **Figure 2.3.2 Figure 12 03 04** by Rye et al. (2016), [CNX OpenStax](#), [CC BY 4.0](#), via Wikimedia Commons

References

Canham, L. (2017). Figure 4. Independent assortment as seen on the same chromosome. [digital image]. In Locke, J., Harrington, M., Canham, L. and Min Ku Kang (Eds.), *Open Genetics Lectures, Fall 2017* (Chapter 17, p. 2). Dataverse/BCcampus. http://solr.bccampus.ca:8001/bcc/file/7a7b00f9-fb56-4c49-81a9-cfa3ad80e6d8/1/OpenGeneticsLectures_Fall2017.pdf

Rye, C., Wise, R., Jurukovski, V., DeSaix, J., Choi, J., & Avissar, Y. (2016, October 21). Figure 11.3 Crossover occurs between non-sister chromatids of homologous chromosomes [digital image]. CNX *OpenStax Biology* (Chapter 11). <https://openstax.org/books/biology/pages/11-1-the-process-of-meiosis>

Long Descriptions

- **Figure 2.3.1** Crossing over shown using two pairs of homologous chromosomes to demonstrate: one pair colored in two shades of green and the other pair colored in two shades of blue. The positioning of the two pairs of homologous chromosomes is shown during Metaphase I, but without crossing over occurring. The resulting gametes are shown without any recombination. The other pair of homologous chromosomes crossing over is shown to be occurring between non-sister chromatids of a pair of the homologous chromosomes, resulting in recombinant gametes. [Back to [Figure 2.3.1](#)]
- **Figure 2.3.2** A pair of homologous chromosomes, one colored blue and one colored red are shown crossing over between non-sister chromatids, resulting in recombinant chromosomes alongside non-recombinant chromosomes. [Back to [Figure 2.3.2](#)]

2.4 A Dihybrid Cross Showing Mendel's Second Law (Independent Assortment)

Mendel found that each locus had two alleles that segregated themselves during the creation of gametes. He wondered whether dealing with multiple traits at a time would affect this segregation, so he created a **dihybrid cross**. The distribution of offspring from his experiments led him to formulate **Mendel's Second Law**, the **Law of Independent Assortment**, which states that the segregation of alleles at one locus will not influence the segregation of alleles at another locus during gamete formation – the alleles segregate independently. Next, we will discuss how he came to this understanding, given that independent assortment occurs.

Mendel's Second Law

To analyze the simultaneous segregation of two traits at the same time in the same individual, he crossed a pure-breeding line of green, wrinkled peas with a pure-breeding line of yellow, round peas. This produced F₁ progeny that had all yellow and round peas. They were called **dihybrids** because they carried two alleles at each of the two loci (**Figure 2.4.1**).

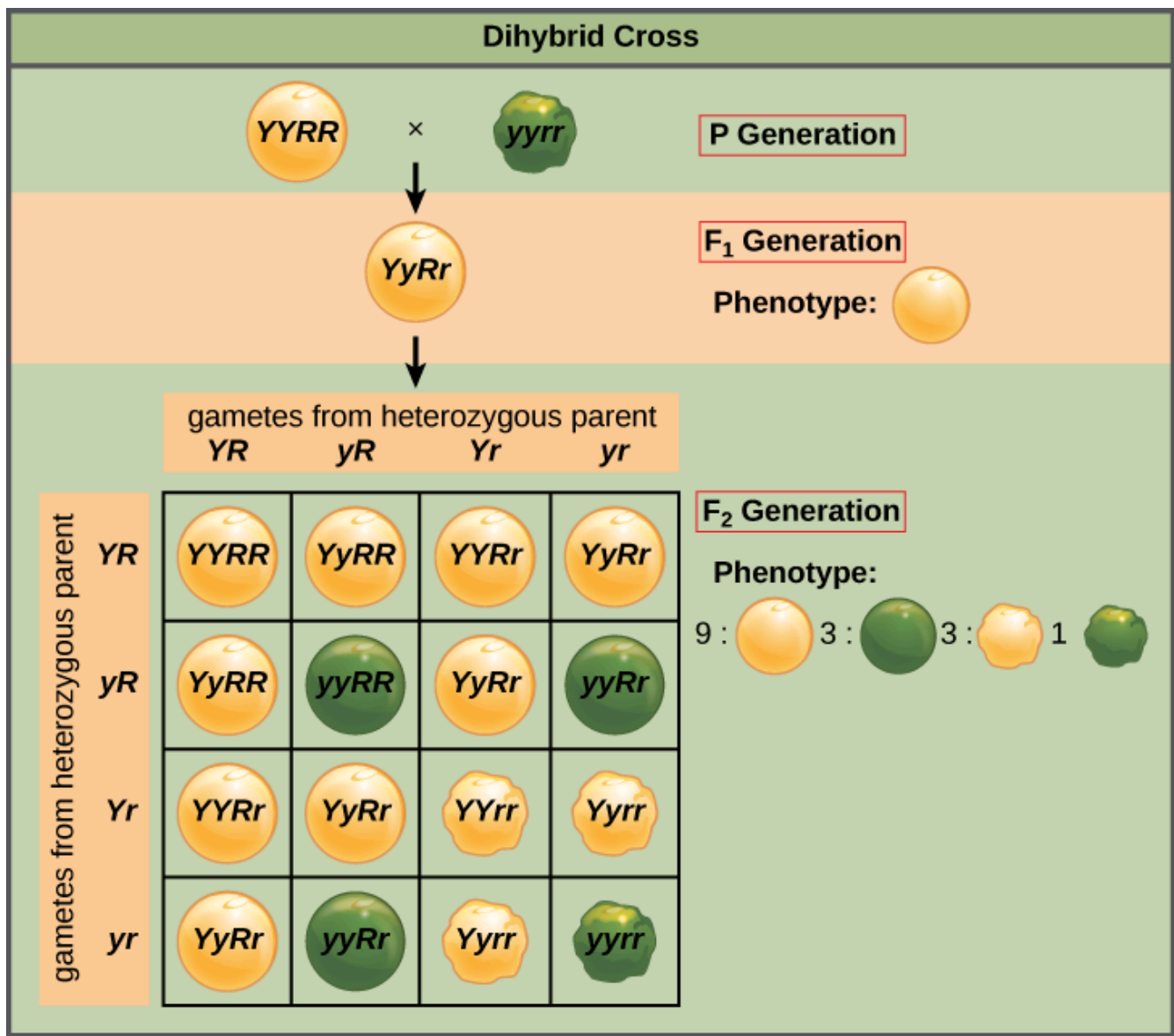

Figure 2.4.1 Two Pure-Breeding Lines are Crossed to Produce Dihybrids in the F₁ Generation. These F₁ are crossed to produce four phenotypic classes, which appear in a 9:3:3:1 ratio. [[Long description](#)]

From **Figure 2.4.1**, we know that yellow and round are dominant, and green and wrinkled are recessive. If the inheritance of seed colour was truly independent of seed shape, then when the F₁ dihybrids were crossed to each other, a 3:1 ratio of one trait should be observed within each phenotypic class of the other trait (**Figure 2.4.1**). Using the product law, we would therefore predict that if $\frac{3}{4}$ of the progeny were yellow, and $\frac{3}{4}$ of the progeny were round, then $\frac{3}{4} \times \frac{3}{4} = \frac{9}{16}$ of the progeny would be both round and yellow (**Table 2.4.1**).

Likewise, $\frac{3}{4} \times \frac{1}{4} = \frac{3}{16}$ of the progeny would be both round and green. And $\frac{3}{4} \times \frac{1}{4} = \frac{3}{16}$ of the progeny would be both wrinkled and yellow. And $\frac{1}{4} \times \frac{1}{4} = \frac{1}{16}$ of the progeny would be both wrinkled and green. So by applying the product rule to all of these combinations of phenotypes, we can predict that if the two loci assort independently in a **9:3:3:1** phenotypic ratio among the progeny of this dihybrid cross, if certain conditions are met (see section below). Indeed,

9:3:3:1 is very close to the ratio Mendel observed in his studies of dihybrid crosses, leading him to formulate his Second Law, the **Law of Independent Assortment**.

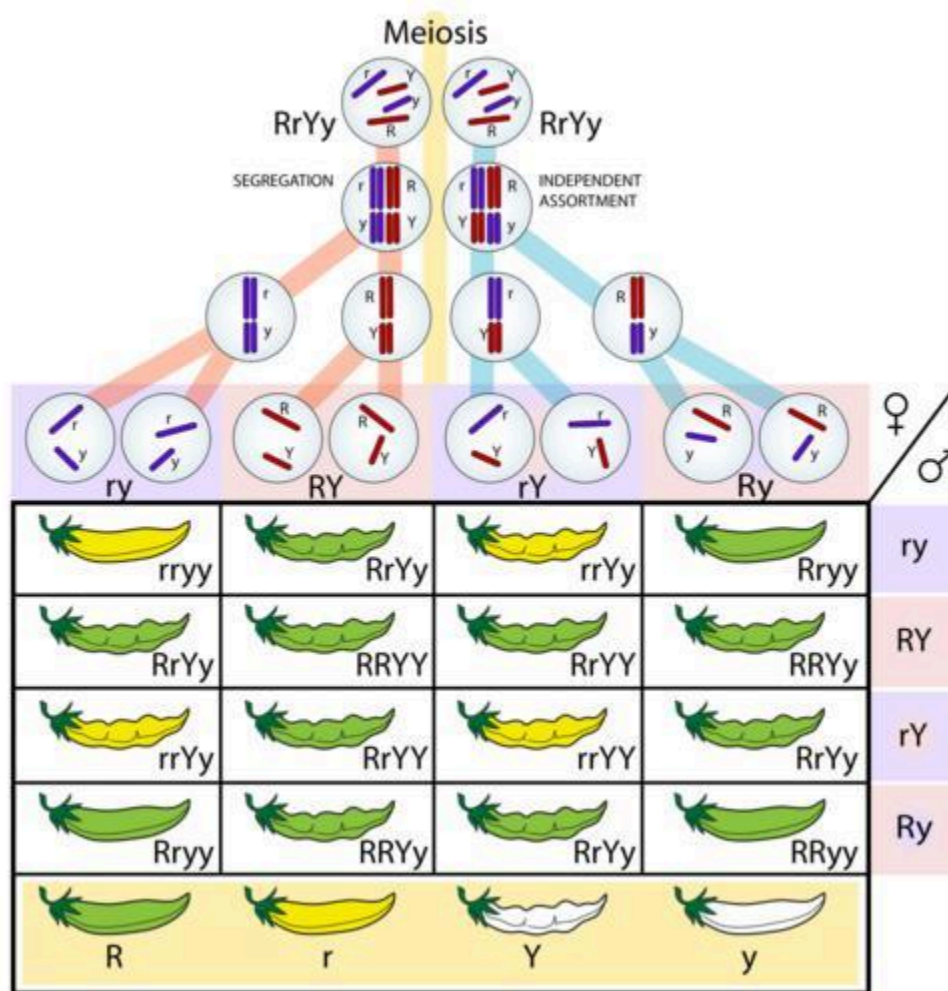

Figure 2.4.2 Demonstration of Mendel's Two Laws – Segregation and Independent Assortment [[Long description](#)]

Table 2.4.1 Phenotypic Classes Expected in Monohybrid and Dihybrid Crosses for Two Seed Traits in Peas

Frequency of Phenotypic Crosses Within Separate Monohybrid Crosses

- Seed shape: $\frac{3}{4}$ round, $\frac{1}{4}$ wrinkled
- Seed colour: $\frac{3}{4}$ yellow, $\frac{1}{4}$ green

Frequency of Phenotypic Crosses Within a Dihybrid Cross

$\frac{3}{4}$ round & $\frac{3}{4}$ yellow = $\frac{9}{16}$ round & yellow
 $\frac{3}{4}$ round & $\frac{1}{4}$ green = $\frac{3}{16}$ round & green
 $\frac{1}{4}$ wrinkled & $\frac{3}{4}$ yellow = $\frac{3}{16}$ wrinkled & yellow
 $\frac{1}{4}$ wrinkled & $\frac{1}{4}$ green = $\frac{1}{16}$ wrinkled & green

The 9:3:3:1 phenotypic ratio that we calculated using the product rule could also be obtained using Punnett Square (Figure 2.4.2). First, we list the genotypes of the possible gametes along each axis of the Punnett Square. In a diploid with two heterozygous genes of interest, there are up to four combinations of alleles in the gametes of each parent. The gametes from the respective rows and column are then combined in the each cell of the array. When working with two loci, genotypes are written with the symbols for both alleles of one locus, followed by both alleles of the next locus (e.g., AaBb, not ABab). Note that the order in which the loci are written does not imply anything about the actual position of the loci on the chromosomes.

To calculate the expected phenotypic ratios, we assign a phenotype to each of the 16 genotypes in the Punnett Square, based on our knowledge of the alleles and their dominance relationships.

In the case of Mendel's seeds, any genotype with at least one R allele and one Y allele will be round and yellow. We can represent all of four of the different genotypes shown in these cells with the notation (R_Y_), where the blank line (__) means "any allele". The three genotypic classes that have at least one R allele and are homozygous recessive for y (i.e., R_yy) will have a round, green phenotype. Conversely, the three classes that are homozygous recessive r, but have at least one Y allele (rrY_) will have wrinkled, yellow seeds. Finally, the rarest phenotypic class of wrinkled, green seeds is produced by the doubly homozygous recessive genotype, rryy, which is expected to occur in only one of the sixteen possible offspring represented in the square.

Take a look at the following video, *Dihybrid Cross Explained*, by Nicole Lantz (2020) on YouTube, on some worked examples of Dihybrid crosses.



A YouTube element has been excluded from this version of the text. You can view it online here:

<https://opengenetics.pressbooks.tru.ca/?p=392>

Assumptions of the 9:3:3:1 Ratio

Both the product rule and the Punnett Square approaches showed that a 9:3:3:1 phenotypic ratio is expected among the progeny of a dihybrid cross such as Mendel's $RrYy \times RrYy$. In making these calculations, we assumed that:

1. Alleles at each locus segregate independently of the alleles at the other;
2. One allele at each locus is completely dominant (the other recessive); and
3. Each of four possible phenotypes can be distinguished unambiguously, with no interactions between the two genes that would interfere with determining the genotype correctly.

For simplicity, most student examples involve easily scored phenotypes, such as pigmentation or other changes in visible structures. However, keep in mind that the analysis of segregation ratios of any two marker loci can provide insight into their relative positions on chromosomes.

Deviations from the 9:3:3:1 Phenotypic Ratio

There can be deviations from the 9:3:3:1 phenotypic ratio. These situations may indicate that one or more of the above conditions has not been met. Modified ratios in the progeny of a dihybrid cross can, therefore, reveal useful information about the genes involved. One such example is linkage.

Linkage is one of the most important reasons for distortion of the ratios expected from independent assortment. Two loci show linkage if they are located close together on the same chromosome. This close proximity alters the frequency of allele combinations in the gametes. We will return to the concept of linkage later on. Deviations from 9:3:3:1 ratios can also be due to interactions between genes, such as epistasis, duplicate gene action and complementary gene action.

Media Attributions

- **Figure 2.4.1** [Figure 12 03 02](#) by Rye et al. (2016), [CNX OpenStax](#), [CC BY 4.0](#), via Wikimedia Commons
- **Figure 2.4.2** [Independent Assortment & Segregation](#) by [Giac83](#) (derivative) from [original work](#) by Mariana Ruiz Villarreal ([LadyofHats](#)), [public domain](#), via Wikimedia Commons

References

Rye, C., Wise, R., Jurukovski, V., DeSaix, J., Choi, J., & Avissar, Y. (2016, October 21). Figure 12.5 A test cross can be performed to... [digital image]. *CNX OpenStax Biology* (Chapter 12). <https://openstax.org/books/biology/pages/12-2-characteristics-and-traits>

Giac83. (2009, February 14). Independent assortment & segregation [digital image]. Wikimedia Commons. https://commons.wikimedia.org/wiki/File:Independent_assortment_&_segregation-it.svg (original by Ladyofhats)

Nicole Lantz. (2020, April 17). Dihybrid cross explained [Video file]. YouTube. <https://www.youtube.com/watch?v=fe5kSSs83qc>

Long Description

- **Figure 2.4.1** A Punnett square represents a dihybrid cross, using green and yellow seeds which are either round or wrinkled to demonstrate. The parental genotypes are pure bred lines, YYRR and yyrr, which are yellow round seeds and green wrinkled seeds respectively. The F1 generation is all heterozygous for both traits. The F2 generation is shown, with the production of sixteen offspring, being produced in the typical dihybrid ratio of 9:3:3:1. [Back to [Figure 2.4.1](#)]
- **Figure 2.4.2** Details of segregation and independent assortment are illustrated by green and yellow pods, which are either smooth or constricted to represent the variety of phenotypes appearing in the F2 generation of a dihybrid cross. These occur in the typical 9:3:3:1 phenotypic ratio. [Back to [Figure 2.4.2](#)]

2.5 The Dihybrid Test Cross

While the cross of an $F_1 \times F_1$ gives a ratio of 9:3:3:1, there is a better, easier cross to test for independent assortment: the dihybrid test cross. In a dihybrid test cross, independent assortment is seen as a ratio of 1:1:1:1, which is easier to score than the 9:3:3:1 ratio. This test cross will also be easier to use when testing for linkage.

Like in monohybrid crosses ([Chapter 1](#)), you can do test crosses with dihybrids to determine the genotype of an individual with dominant phenotypes, to see if they are heterozygous or homozygous dominant. This type of cross is set up in the same fashion; an individual with an unknown genotype in two loci is crossed to an individual that is homozygous recessive for both loci.

♀	♂	R;Y	R;Y	R;Y	R;Y
r;y	R/r	R/r	R/r	R/r	R/r
r;y	Y/y	Y/y	Y/y	Y/y	Y/y
R;Y	R/r	R/r	R/r	R/r	R/r
R;Y	Y/y	Y/y	Y/y	Y/y	Y/y
r;y	R/r	R/r	R/r	R/r	R/r
r;y	Y/y	Y/y	Y/y	Y/y	Y/y

♀	♂	R;Y	R;y	R;Y	R;y
r;y	R/r	R/r	R/r	R/r	R/r
r;y	Y/y	y/y	Y/y	y/y	y/y
R;Y	R/r	R/r	R/r	R/r	R/r
R;Y	Y/y	y/y	Y/y	y/y	y/y
r;y	R/r	R/r	R/r	R/r	R/r
r;y	Y/y	y/y	Y/y	y/y	y/y

Figure 2.5.1 Punnett Square for a Test Cross. The tester in both cases is the male with the genotype $r/r ; y/y$. On the left, the unknown has a genotype of $R/R ; Y/Y$. On the right, the unknown has the genotype $R/R ; Y/y$. [[Long description](#)]

Take a look at the video, *Two-Gene Test Cross Explained*, by Nicole Lantz (2020) on YouTube, for some worked examples.

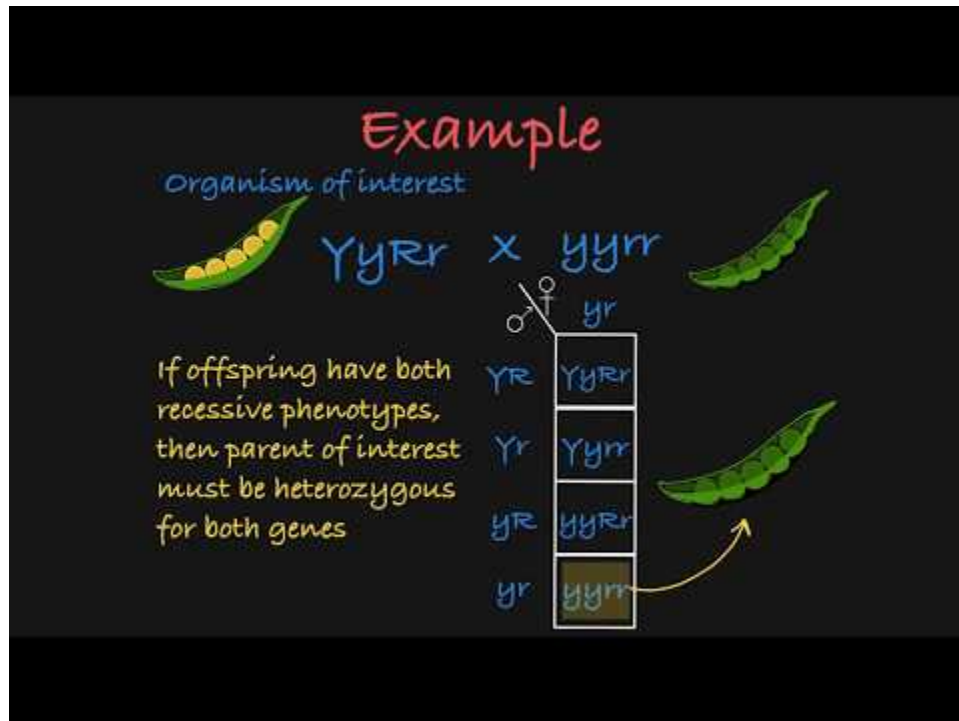

A YouTube element has been excluded from this version of the text. You can view it online here:

<https://opengenetics.pressbooks.tru.ca/?p=395>

Punnett squares should be done ahead of the crosses, so you know what to expect for any of the possible outcomes. Using the example from the rest of this chapter, you cross a double homozygous recessive pea plant (r/r ; y/y . green and wrinkled) to an unknown individual that has two dominant phenotypes ($R/_$; $Y/_$. yellow and round). There are four possible genotypes the unknown individual could be: R/R ; Y/Y or R/R ; Y/y or R/r ; Y/Y or R/r ; Y/y . The Punnett squares for the first two are shown in **Figure 2.5.1**. Notice on the left, you only get the dominant phenotype for both, so you know both genes in the unknown are homozygous dominant. On the right, you get only the dominant phenotype for round peas – but you get 50% yellow and 50% green peas, showing that the unknown is homozygous for round, but heterozygous for colour of the peas. **Figure 2.5.2** is blank for you to fill in the other two gamete and genotype possibilities.

♀	♂				
	r;y				
	r;y				
	r;y				
	r;y				

♀	♂				
	r;Y				
	r;Y				
	r;Y				
	r;Y				

Figure 2.5.2 Blank Punnett Squares to Fill in the Other Two Possibilities of the Test Cross. [\[Long description\]](#)

Media Attributions

- **Figure 2.5.1**, [Original](#) by L.Canham (2017), [CC BY-NC 3.0](#)
- **Figure 2.5.2**, [Original](#) by L.Canham (2017), [CC BY-NC 3.0](#)

References

Canham, L. (2017). Figures: 7. Punnett square for a test cross; 8. Blank Punnett squares to fill in the other two possibilities of the test cross [digital images]. In Locke, J., Harrington, M., Canham, L. and Min Ku Kang (Eds.), *Open Genetics Lectures, Fall 2017* (Chapter 17, p. 6-7). Dataverse/ BCcampus. http://solr.bccampus.ca:8001/bcc/file/7a7b00f9-fb56-4c49-81a9-cfa3ad80e6d8/1/OpenGeneticsLectures_Fall2017.pdf

Nicole Lantz. (2020, May 5). Two-gene test cross explained [Video file]. YouTube. <https://youtu.be/GM0by2axiLM>

Long Descriptions

- **Figure 2.5.1** Two Punnett squares: The first is a testcross between a dihybrid homozygous dominant organism (RRYY) and the tester, which is a dihybrid homozygous recessive organism (rryy). The offspring and their genotypes in this test cross are shown, with all possessing the heterozygous condition for both traits (RrYy). The second is a testcross between a dihybrid heterozygous organism (RrYy) and the tester, which is a dihybrid homozygous recessive organism (rryy). The offspring and their genotypes in this test cross are shown, with half possessing the heterozygous condition for both traits (RrYy) and the other half expressing the genotype Rryy. [Back to [Figure 2.5.1](#)]
- **Figure 2.5.2** A blank Punnett square can be used for practice, and to fill in the other two gamete and genotype possibilities for the question in the text directly preceding this figure. [Back to [Figure 2.5.2](#)]

2.6 Predicting Ratios in Genetic Crosses - Rules of Probability

So far, in our discussion of Mendel's Laws, we have mentioned various (predicted) ratios in offspring produced from monohybrid and dihybrid crosses. A predicted ratio simply indicates the probability of a particular outcome (genotype or phenotype) we should expect in a genetic cross. As such, Mendel's results have been shown to reflect the basic rules of Probability. In genetics, we use **Probability** (the likelihood of the occurrence of a particular event) to predict the outcome of a genetic cross. The following two rules of Probability are very useful in conducting genetic crosses:

1. Multiplication or Product rule: The product rule of probability can be applied to the phenomenon of the independent transmission of traits. It states that the probability of two independent events occurring together can be calculated by multiplying the individual probabilities of each event occurring alone.

For example, the Probability of event A occurring **AND** event B occurring is $= P(A \text{ and } B) = P(A) \times P(B)$

The word "and" indicates you should apply the product rule.

2. Addition or sum rule: The sum rule is applied when considering two mutually-exclusive outcomes that can result from more than one pathway. It states that the probability of the occurrence of one event or the other, of two mutually-exclusive events, is the sum of their individual probabilities.

For example, the Probability of event A occurring **OR** event B occurring is $= P(A \text{ or } B) = P(A) + P(B)$

The word "or" indicates that you should apply the sum rule.

Try the following question to test your understanding!



An interactive or media element has been excluded from this version of the text. You can view it online here:

<https://opengenetics.pressbooks.tru.ca/?p=1270>

Take a look at the video, *Probability in Genetics: Multiplication and Addition Rules*, by Bozeman Science (2011) on YouTube, which explains these two rules of probability further.



A YouTube element has been excluded from this version of the text. You can view it online here:

<https://opengenetics.pressbooks.tru.ca/?p=1270>

Reference

Bozeman Science. (2011, December 13). Genetics: Multiplication and addition rules [Video file]. YouTube. https://www.youtube.com/watch?v=y4Ne9DXk_Jc

Chapter 2 Summary

The topics covered in this chapter can be summarized as follows:

- The alleles of loci in different chromosomes are inherited independently of each other.
- The expected phenotypic ratio of a dihybrid cross is 9:3:3:1.
- The 9:3:3:1 ratio can be modified if the loci are not simple dominant/recessive to each other, if there are gene interactions, or if the two loci are linked.
- A test cross gives a ratio of 1:1:1:1 for loci that assort independently.

Take a look at this video, *Mendelian Genetics and Punnett Squares*, from Professor Dave Explains (2017), which gives a great summary of what we have covered so far!

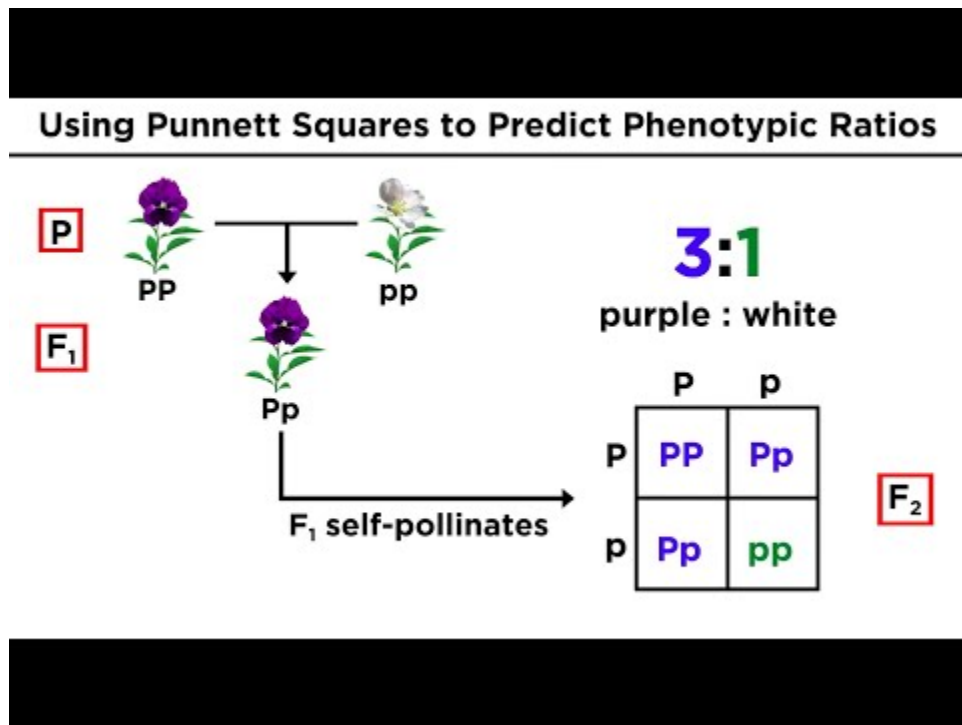

A YouTube element has been excluded from this version of the text. You can view it online here:

<https://opengenetics.pressbooks.tru.ca/?p=398>

Reference

Professor Dave Explains. (2017). Mendelian genetics and Punnett squares [Video file]. YouTube.

https://www.youtube.com/watch?v=3f_eisNPpnc

Key Terms in Chapter 2

Key Terms – Mendel's Second Law: Independent Assortment

- 9:3:3:1
- blended inheritance
- crossing over
- dihybrid cross
- dihybrid
- heritable traits
- Independent Assortment (IA)
- Law of Independent Assortment
- Linkage
- Mendel's Second Law
- particulate inheritance

Chapter 2 Study Questions

1. [Figure 2.5.1](#) shows Punnett squares for two of the four possible test crosses. Fill in the Punnett squares in [Figure 2.5.2](#) for the other two possible genotypes of the unknown that aren't shown.
2. Based on meiosis, when dealing with two loci, there will always be four distinct gamete types. But if the organism is homozygous, like the tester, all those gametes will look the same. In this situation, when writing a Punnett square, is it necessary to write out the four similar gametes? How would you re-draw the Punnett square on the right in **Figure 2.5.1**?
3. If two loci assort independently, then the $AABB \times aabb$ cross will result in dihybrid progeny, which when crossed together will give ratios of 9:3:3:1 in the F_2 , assuming "A" and "B" are dominant to "a" and "b", respectively. Now, assume that locus "A" and "B" are not assorting independently but are linked with a RF of 20%. That is the "AB" and "ab" combinations are more likely. How will this affect the 9:3:3:1 ratio? What if the combinations are "Ab" and "aB"?c
4. Perform the same first cross as in Question 3, but make the second cross a test cross ($\times aabb$), with expectation of a 1:1:1:1 ratio. How would the ratio be changed if the two loci were not assorting independently but are somewhat linked?

Chapter 2 Answers

1. ◦

♀ ♂	R;Y	R;Y	r;Y	r;Y
r;y	R/r Y/y	R/r Y/y	r/r Y/y	r/r Y/y
r;y	R/r Y/y	R/r Y/y	r/r Y/y	r/r Y/y
r;y	R/r Y/y	R/r Y/y	r/r Y/y	r/r Y/y
r;y	R/r Y/y	R/r Y/y	r/r Y/y	r/r Y/y

◦

♀ ♂	R;Y	R;y	r;Y	r;y
r;y	R/r Y/y	R/r y/y	r/r Y/y	r/r y/y
r;y	R/r Y/y	R/r y/y	r/r Y/y	r/r y/y
r;y	R/r Y/y	R/r y/y	r/r Y/y	r/r y/y
r;y	R/r Y/y	R/r y/y	r/r Y/y	r/r y/y

2. No, it's not necessary to write out a Punnett square in a true square 2x2 or 4x4, etc. For simplicity you can remove the duplicate gametes, and you will still get the same ratio. It isn't incorrect to write it out fully though. For the

♀ ♂	R;Y	R;y
r;y	R/r Y/y	R/r y/y

Punnett square on the right, you can simplify it as:

3. The 9:3:3:1 ratio would change, depending on whether the two mutants were in coupling or repulsion.
 If in coupling (AB/ab), the 9 and 1 would go up and the 3s would go down (10.6: 1.44: 1.44: 2.56).
 If in repulsion (Ab/aB), the 9 and 1 would go down and the 3s up. (8.16: 3.84: 3.85: 0.16)
4. Two classes (the parentals) would increase, while two classes would decrease (the recombinants).

CHAPTER 3 - THE CELL CYCLE AND MITOSIS

3.1 Introduction

Learning Objectives

- Describe the various steps of the Cell Cycle and Mitosis.
- State the significance of mitosis in maintaining genetic stability.
- Describe the phases of meiosis and the physical occurrences which occur in sex-cells to produce gametes.
- Outline the importance of sexual reproduction to produce genetic variation.
- Compare and contrast mitosis and meiosis.

Cell division is the process by which a parent cell divides into two or more daughter cells. Cell division usually occurs as part of a larger process, called the **Cell Cycle**, which we will look at in detail in this chapter. In eukaryotes, there are two distinct types of cell division; a vegetative division, whereby each daughter cell is genetically identical to the parent cell (mitosis) and a reproductive cell division, whereby the number of chromosomes in the daughter cells is reduced by half to produce haploid gametes (meiosis). We have already looked at the process of Meiosis in [Chapter 1](#) and [Chapter 2](#), as the events in meiosis tie in strongly with Mendel's Laws. Here, we will look closely at **Mitosis**. Cell growth and division is essential to asexual reproduction and the development of multicellular organisms, and the transmission of genetic information is accomplished in the cellular process of mitosis. This process ensures that a cell division occurs, with each daughter cell inheriting identical genetic material, (i.e., exactly one copy of each chromosome present in the parental cell).

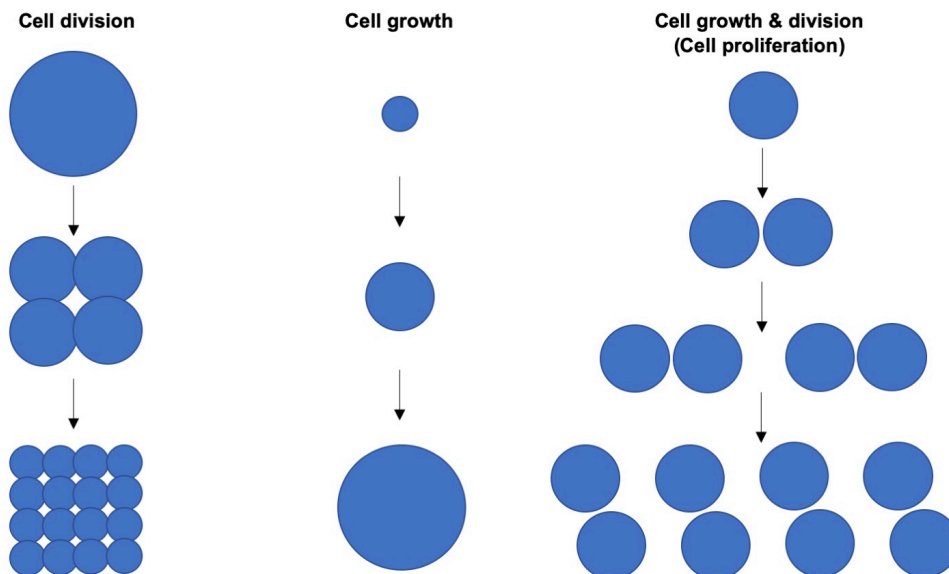

Figure 3.1.1 Generalized Image of Cell Growth and Cell Division [[Long description](#)]

Media Attribution

- **Figure 3.1.1** [Cell Proliferation](#) by [Drosophila07](#) (2020), [CC BY-SA 4.0](#), via Wikimedia Commons

Reference

Drosophila01. (2020, July 27). Cell proliferation [digital image]. Wikimedia Commons. https://commons.wikimedia.org/wiki/File:Cell_proliferation.jpg

Long Description

- **Figure 3.1.1** Blue circles (cells) demonstrating the various stages of cell division: A large blue circle is seen dividing into four, then sixteen circles to represent *cell division*. Next, a small blue circle is shown to become progressively bigger, to exemplify *cell growth*. And finally, multiple blue circles are used to show both cell growth and cell division occurring at the same time, which is known as *cell proliferation*. [Back to [Figure 3.1.1](#)]

3.2 The Typical Cell Cycle

The Cell Cycle is the repeating pattern of cell growth (increase in size), followed by nuclear and then cytoplasmic division (splitting of one cell to produce identical daughter cells in mitosis, or to produce unique gametes in meiosis). The cycle is divided into four (4) main stages or phases: Gap 1 (**G₁**), Synthesis (**S**), Gap 2 (**G₂**), and either Mitosis or Meiosis (**M**). G₁, S and G₂ are collectively called **Interphase (Figure 3.2.1)**.

The first stage of interphase is a lag period, and is called Gap 1 (G₁). It is the first part of interphase. This is where the cell does its normal cellular functions and grows in size – particularly after mitosis when the daughters are half the size of the mother cell. This stage ends with the onset of the DNA synthesis (S) phase, during which each chromosome is replicated. Though the chromosomes are not condensed yet, because S phase is still part of interphase, they are replicated as two sister chromatids attached at the centromere (**Figure 3.2.2**). Still in interphase and following replication, there is another lag phase, called Gap 2 (G₂). In G₂, the cell continues to grow and acquire the proteins necessary for cell division. There are various checkpoint stages, as shown in Figure 1, which are controlled by cyclins. Cyclins are a family of proteins that control the progression of a cell through the cell cycle by activating cyclin-dependent kinase enzymes, or group of enzymes, required for synthesis of cell cycle. If there are any problems with replication or acquiring the needed proteins, the cell cycle will arrest, until it can fix itself or die. The final stage is mitosis (M), where the cell undergoes cell division.

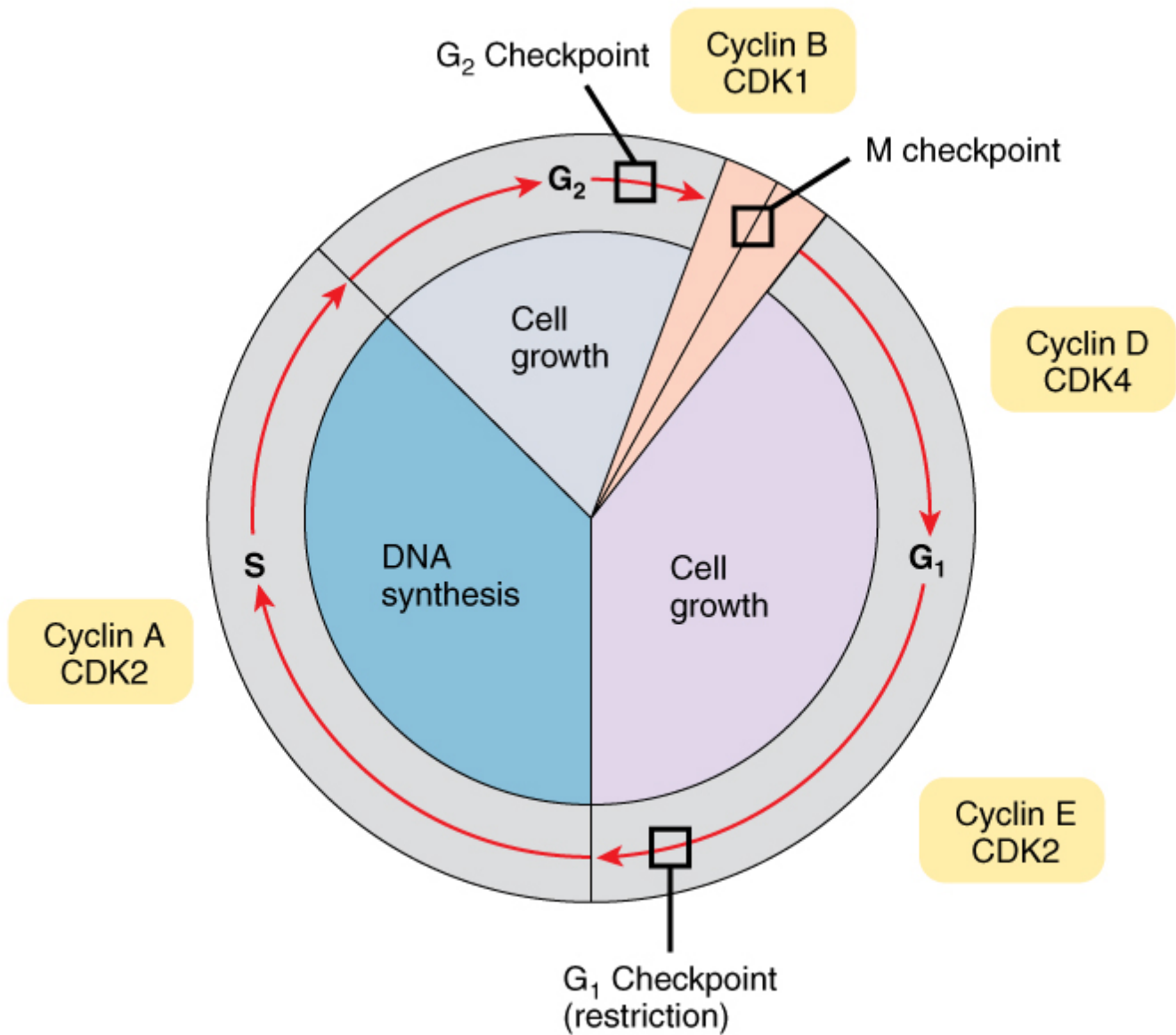

Figure 3.2.1 A Typical Cell Cycle with Cyclins and Checkpoints Shown [[Long description](#)]

Many variants of this generalized cell cycle also exist. Cells undergoing meiosis do not usually have a G₂ phase. Cells, like hematopoietic stem cells, which are found in the bone marrow and produce all the other blood cells, will consistently go through these phases as they are constantly replicating. Other cells, as in the nervous system, will no longer divide. These cells never leave G₁ phase, and are said to enter a permanent, non-dividing stage called G₀. On the other hand, some cells, like the larval tissues in *Drosophila*, undergo many rounds of DNA synthesis (S) without any mitosis or cell division, leading to endoreduplication. Understanding the control of the cell cycle is an active area of research, particularly because of the relationship between cell division and cancer.

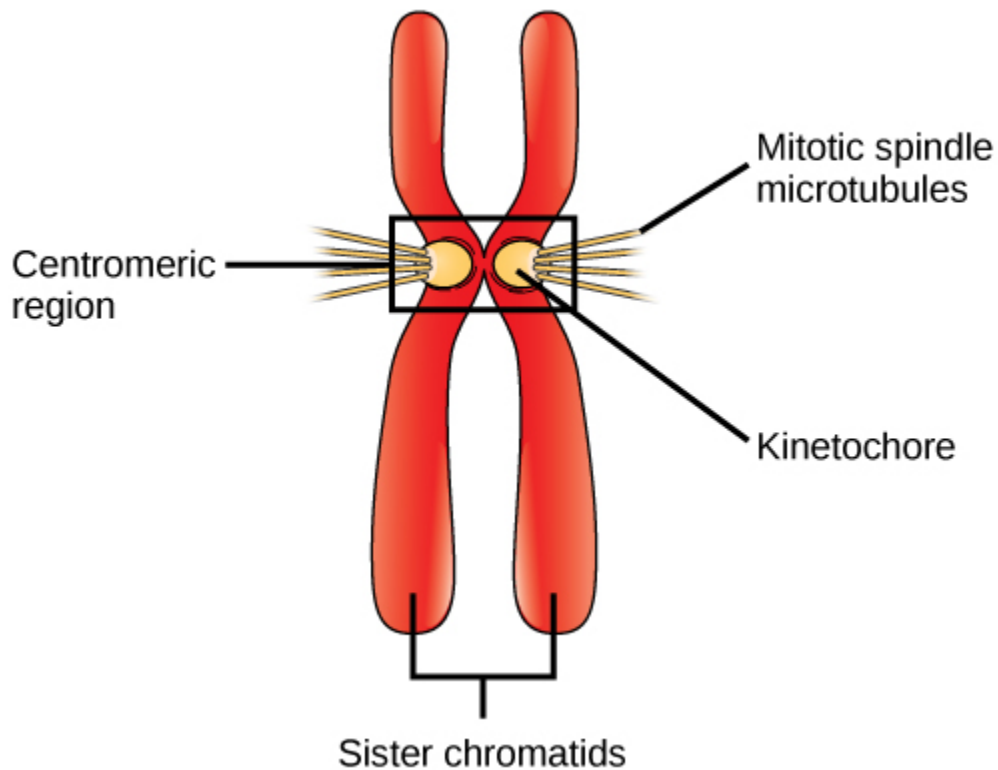

Figure 3.2.2 A Replicated Chromosome (Sister Chromatids) [[Long description](#)]

Media Attributions

- **Figure 3.2.1** [Cell Cycle with Cyclins and Checkpoints](#), by Betts et al. (2013), [OpenStax](#), [CC BY 4.0](#), via Wikimedia Commons
- **Figure 3.2.2** [Sister Chromatids](#) by Rye et al. (2016), [CNX OpenStax](#), [CC BY 4.0](#), via Wikimedia Commons

References

Betts, et al. (2013, Apr 25). Figure 3.33 Control of the cell cycle [digital image]. *Anatomy and Physiology*. OpenStax. <https://openstax.org/books/anatomy-and-physiology/pages/3-5-cell-growth-and-division>

Rye et al. (2016, October 21). Figure 10.7 During prometaphase ... [digital image]. *Biology*. OpenStax. <https://openstax.org/books/biology/pages/10-2-the-cell-cycle>

Long Descriptions

- **Figure 3.2.1** The stages of the cell cycle are similar to a pie chart representation. A large circle is drawn, with sectors of the circle identified to correspond to various stages of the cell cycle, such as the G1 (cell growth), S

(synthesis) and G2 (cell growth) stages. The size of this sector of the circle corresponds to the relative length of time of each stage. Various checkpoints which occur during the cell cycle are also identified where appropriate, along with the cyclin molecules which control the progression through the stages. [Back to [Figure 3.2.1](#)]

- **Figure 3.2.2** A replicated chromosome (sister chromatids) shows the centromeric regions and the mitotic spindle fiber microtubules coming from the kinetochore regions during mitosis. [Back to [Figure 3.2.2](#)]

3.3 Mitosis

During the S-phase of interphase the chromosomes replicate so that each chromosome has two sister **chromatids** attached at the centromere. After S-phase and G₂, the cell enters Mitosis. The first step in mitosis is **prophase**, where the nucleus dissolves and the replicated chromosomes condense into the visible structures we associate with chromosomes. Next is **metaphase**, where the **microtubules** attach to the **kinetochore** and the chromosomes align along the middle of the dividing cell, known as the **metaphase plate**. The kinetochore is the region on the chromosome where the microtubules attach. It contains the centromere and proteins that help the microtubules bind. Then in **anaphase**, each of the sister chromatids from each chromosome gets pulled towards opposite poles of the dividing cell. Finally in **telophase**, identical sets of **unreplicated chromosomes** (single chromatids) are completely separated from each other into the two daughter cells, and the nucleus re-forms around each of the two sets of chromosomes. Following this is the partitioning of the cytoplasm (**cytokinesis**) to complete the process and to make two identical daughter cells. An acronym to remember the main stages of mitosis is iPMAT, where the little (lowercase) i stands for interphase.



An interactive or media element has been excluded from this version of the text. You can view it online here:

<https://opengenetics.pressbooks.tru.ca/?p=513>

Prophase	Prometaphase	Metaphase	Anaphase	Telophase	Cytokinesis
					
<ul style="list-style-type: none"> Chromosomes condense and become visible Spindle fibers emerge from the centrosomes Nuclear envelope breaks down Centrosomes move toward opposite poles 	<ul style="list-style-type: none"> Chromosomes continue to condense Kinetochores appear at the centromeres Mitotic spindle microtubules attach to kinetochores 	<ul style="list-style-type: none"> Chromosomes are lined up at the metaphase plate Each sister chromatid is attached to a spindle fiber originating from opposite poles 	<ul style="list-style-type: none"> Centromeres split in two Sister chromatids (now called chromosomes) are pulled toward opposite poles Certain spindle fibers begin to elongate the cell 	<ul style="list-style-type: none"> Chromosomes arrive at opposite poles and begin to decondense Nuclear envelope material surrounds each set of chromosomes The mitotic spindle breaks down Spindle fibers continue to push poles apart 	<ul style="list-style-type: none"> Animal cells: a cleavage furrow separates the daughter cells Plant cells: a cell plate, the precursor to a new cell wall, separates the daughter cells
					
<p>MITOSIS</p>					

Figure 3.3.1 Summarizing the Various Stages of Mitosis [Long description]

Take a look at the following video, *Cell Biology | Cell Cycle: Interphase & Mitosis*, by Ninja Nerd (2018) on YouTube, which discusses the various stages of the Cell Cycle.

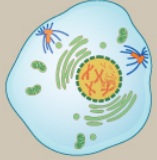
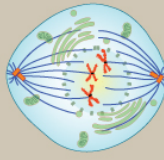
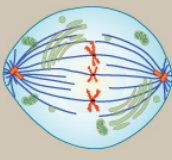
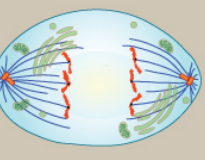
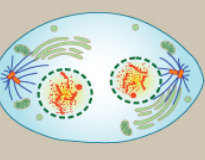
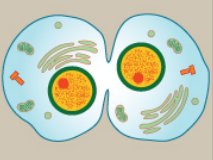
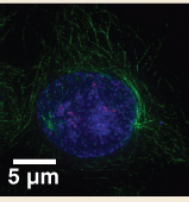
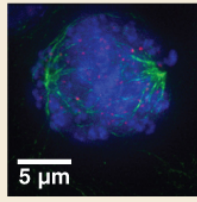
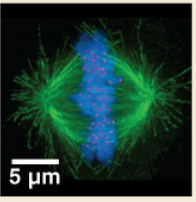
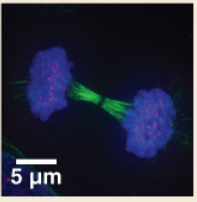
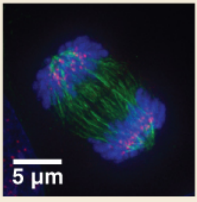
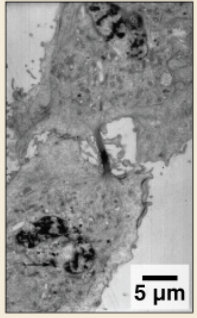
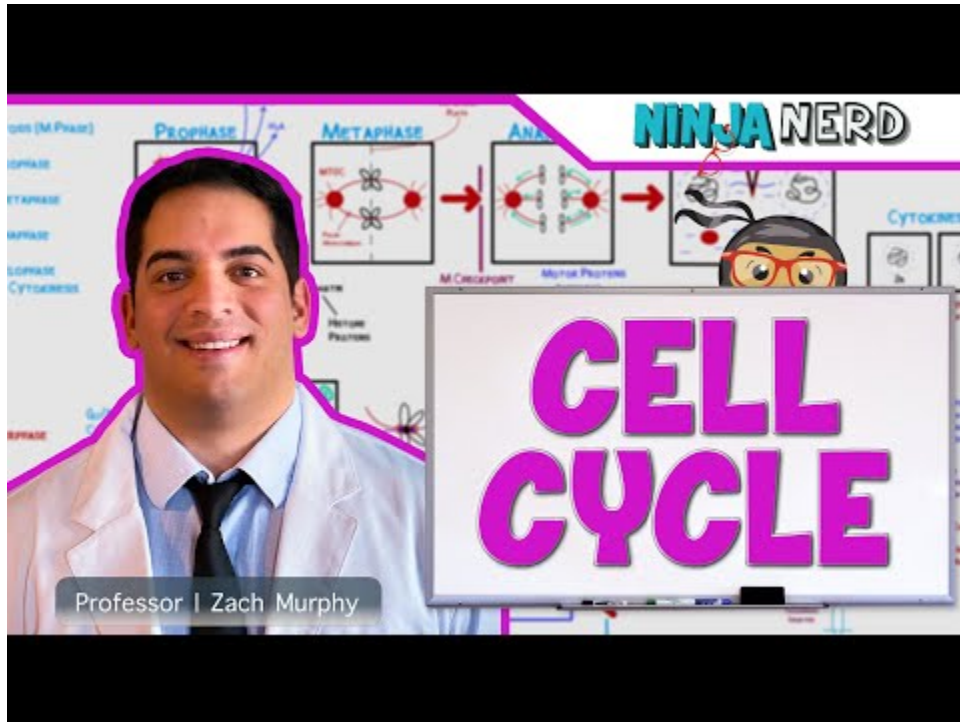

A YouTube element has been excluded from this version of the text. You can view it online here:

<https://opengenetics.pressbooks.tru.ca/?p=513>

You should note that this is a dynamic and ongoing process, and cells don't just jump from one stage to the next.

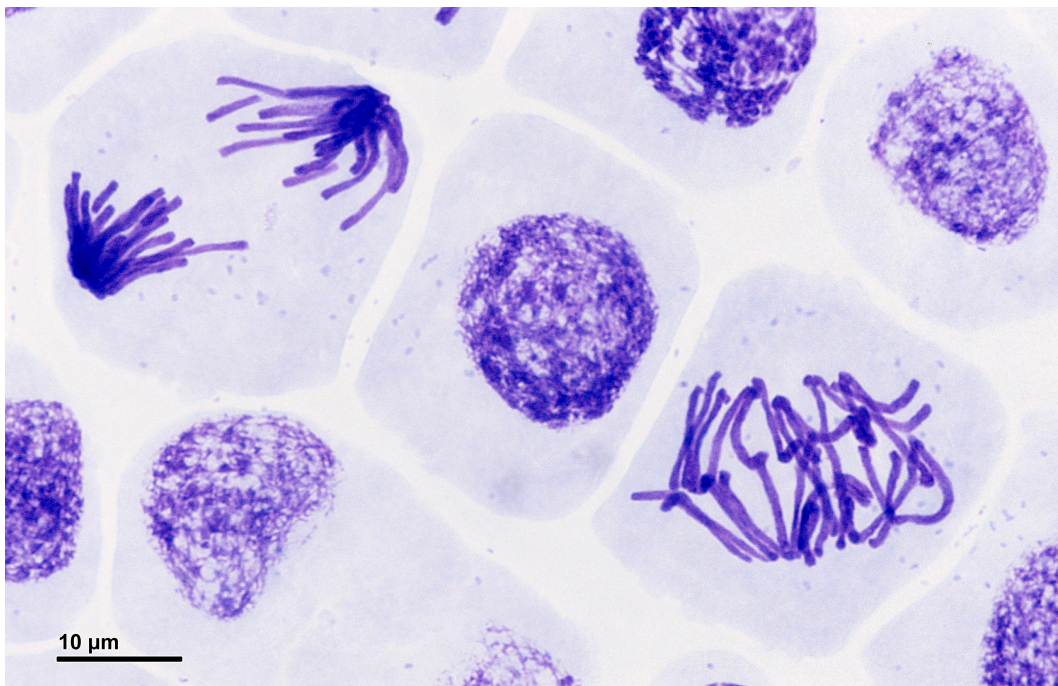

Figure 3.3.2 Root Meristem of *Vicia faba* (Cells in Anaphase, Prophase) [[Long description](#)]

Keep in mind the following points that outline the importance and significance of mitosis:

- Keeps chromosome number constant
- Maintains genetic stability in daughter cells
- Helps in growth and development of the zygote
- Helps in repair and regeneration
- Restores nucleo-plasmic ratio
- Checks cell size and maintains a favourable surface area/volume ratio.

How Mitosis Helps to Maintain Genetic Stability

Mitosis results in the splitting of replicated chromosomes during cell division and facilitates the generation of two new identical daughter cells. Given that chromosomes form from parent chromosomes by making exact copies of their DNA, mitosis helps in preserving and maintaining the genetic stability of a particular population.

Watch the video, *Animation How the Cell Cycle Works*, by Marcin Gorzycki (2018) on YouTube, which discusses the various stages of Mitosis.

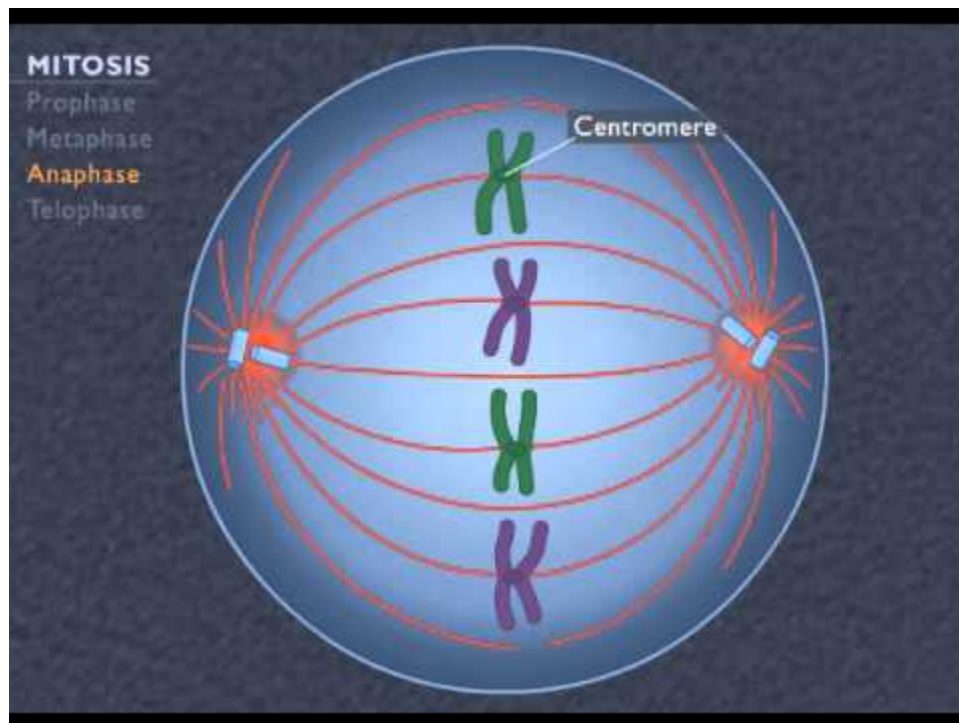

A YouTube element has been excluded from this version of the text. You can view it online here:

<https://opengenetics.pressbooks.tru.ca/?p=513>

Media Attributions

- **Figure 3.3.1** [0331 Stages of Mitosis and Cytokinesis](#) by Betts et al. (2016), [OpenStax](#), [CC BY 4.0](#), via Wikimedia Commons
- **Figure 3.3.2** [Pressed root meristem...](#) by Doc. RNDr. Josef Reischig, CSc. (2014), [Author archives/ Mantis](#), [CC BY-SA 3.0](#), via Wikimedia Commons

References

- Betts et al. (2016, October 21). Figure 3.32 Cell division: Mitosis followed by cytokinesis [digital image]. *Anatomy and Physiology*. OpenStax. <https://openstax.org/books/anatomy-and-physiology/pages/3-5-cell-growth-and-division>
- Marcin Gorzycki. (2013, March 14). Animation how the cell works (video file). YouTube. <https://youtu.be/g7iAVCLZWuM>
- Ninja Nerd. (2018, January 7). Cell biology | Cell cycle: Interphase & mitosis (video file). YouTube. <https://youtu.be/LUDws4Jrlil>
- Reischig, J. (2014). Mitosis: pressure; root meristem; Vicia faba, A, P, 1500x [digital micrographic image]. Mantis. https://www.mantis.cz/mikrofotografie/pages/261_10.html

Long Descriptions

- **Figure 3.3.1** The various stages of mitosis are shown, which include the prophase, prometaphase, metaphase, anaphase, telophase, and cytokinesis. Please refer to the text for details of each stage, and pay special attention to the description of the movement of chromosomes and their occurrences during mitosis. [Back to [Figure 3.3.1](#)]
- **Figure 3.3.2** A vivid slide presents purple-colored stained chromosomes in root cells, which all exemplify various stages of mitosis. In some cells, chromosomes are diffuse; in other cells, chromosomes are lined up at the equator; and in other cells, chromosomes are shown being pulled apart to opposite poles of the cell. [Back to [Figure 3.3.2](#)]

3.4 Amount of DNA (c-value) and Number of Chromosomes (n-value)

The amount of DNA within a cell changes during the following events: fertilization, DNA synthesis and mitosis (**Figure 3.4.1**). We use “c” (or C) to represent the DNA content in a cell, and “n” (or N) to represent the number of complete sets of chromosomes. In a haploid gamete (i.e., sperm or egg), the amount of DNA is 1c, and the number of chromosomes is 1n. Upon fertilization, both the DNA content and the number of chromosomes in the diploid zygote doubles to 2c and 2n, respectively. Following DNA replication, the DNA content doubles again to 4c, but each pair of sister chromatids are still attached by the centromere, and so is still counted as a single chromosome (a **replicated chromosome**), so the number of chromosomes remains unchanged at 2n. If the cell undergoes mitosis, each daughter cell will return to 2c and 2n, because it will receive half of the DNA, and one of each pair of sister chromatids.

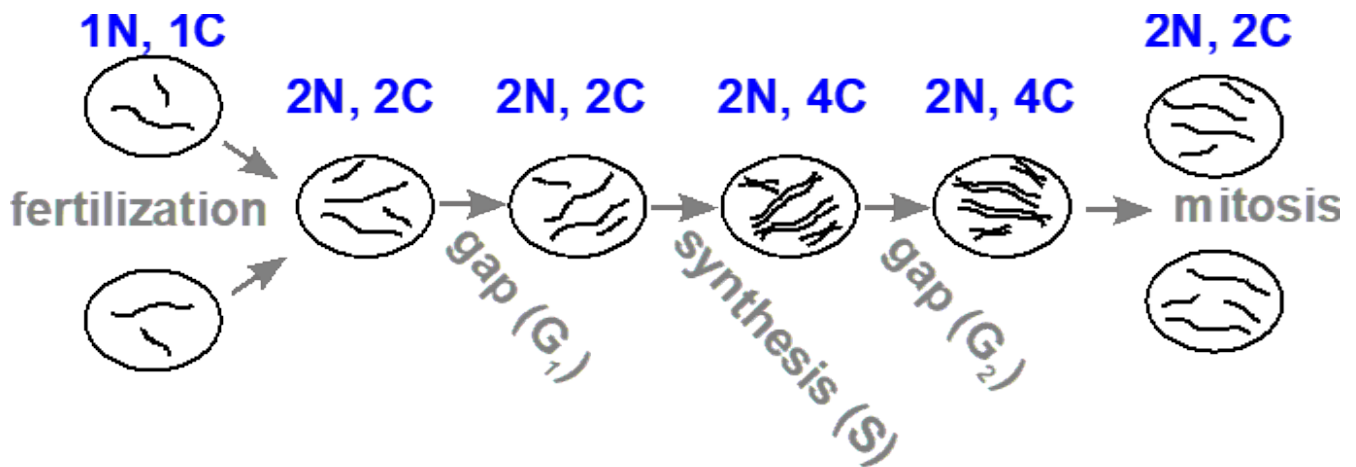

Figure 3.4.1 Changes in DNA and Chromosome Content During the Cell Cycle and Mitosis. For simplicity, nuclear membranes are not shown, and all chromosomes are represented in a similar stage of condensation. [\[Long description\]](#)

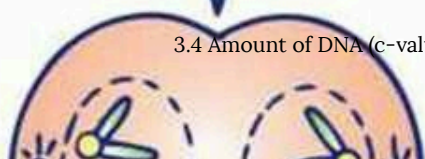
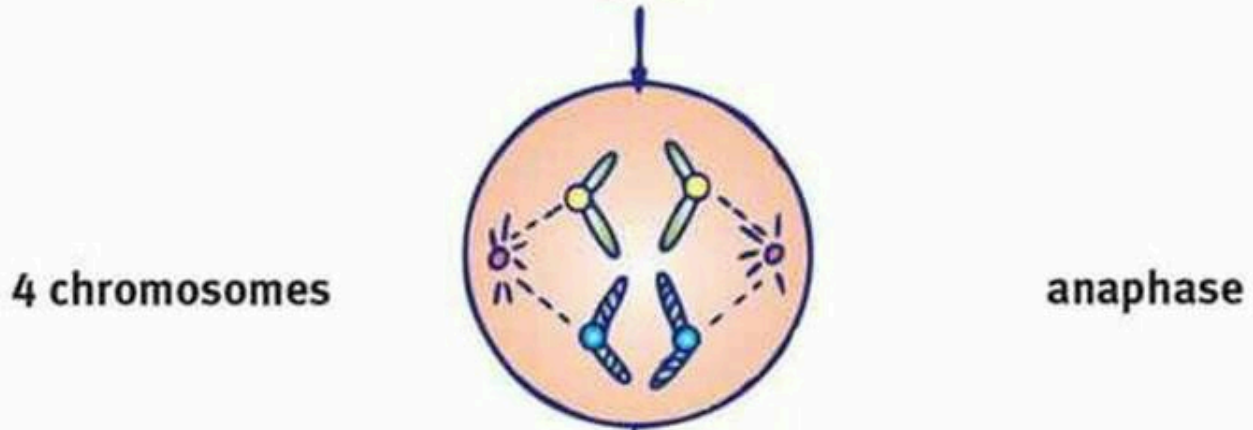
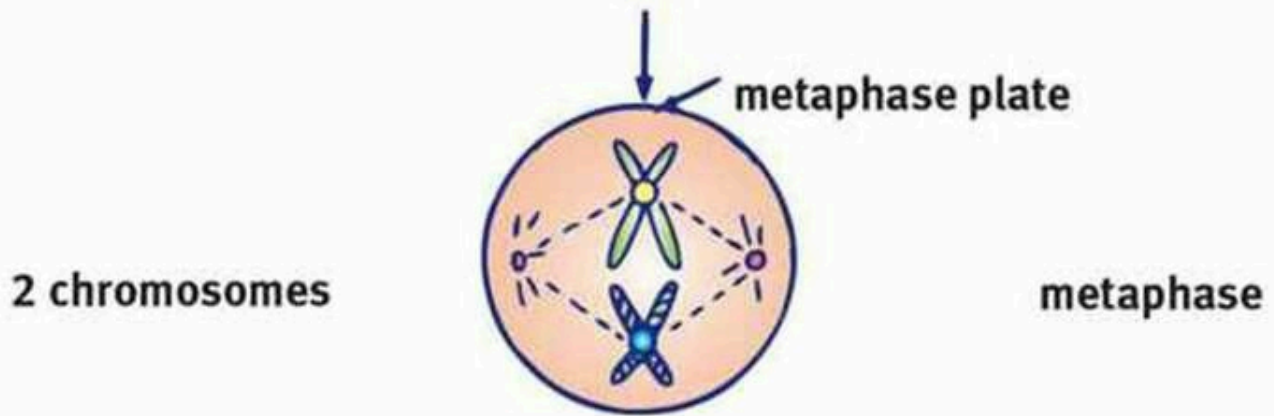
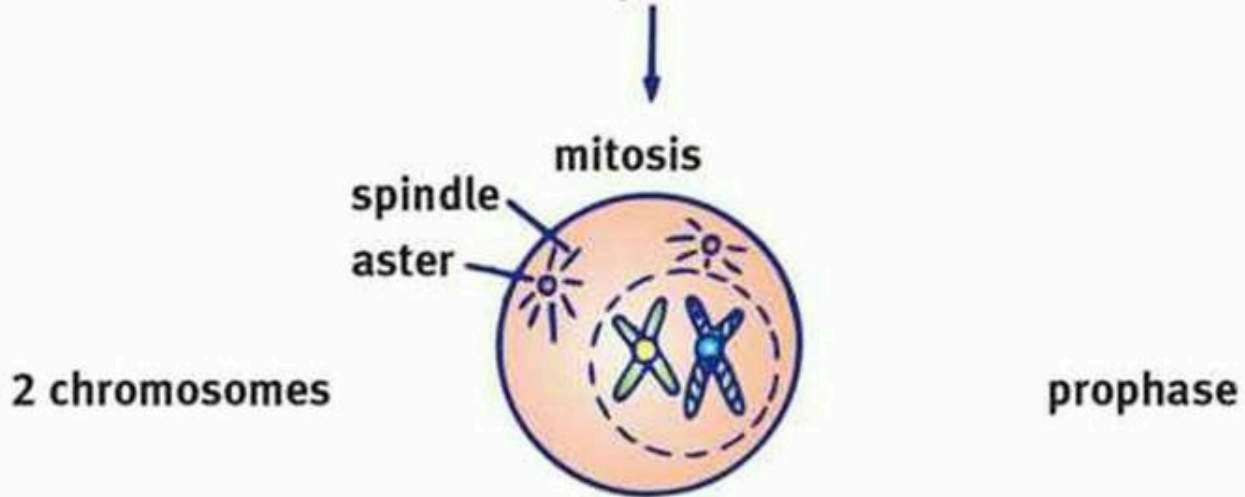
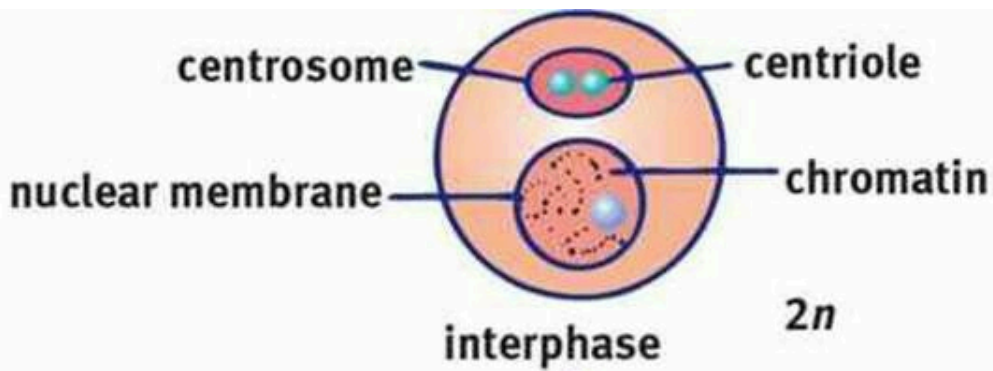

Figure 3.4.2 Chromosomes and Mitosis. [[Long description](#)]

The c-Value of the Nuclear Genome

The complete set of DNA within the nucleus of any organism is called its **nuclear genome** and is measured as the **c-value** in units of either the number of base pairs or picograms of DNA. There is a general correlation between the nuclear DNA content of a genome (i.e., the C-value) and the physical size or complexity of an organism. Compare the size of *E. coli* and humans, for example, in the **Table 3.4.1** There are, however, many exceptions to this generalization, such as the human genome contains only $\{3.2\} \times \{10^9\}$ DNA bases, while the wheat genome contains $\{17\} \times \{10^9\}$ DNA bases – almost 6 times as much. The Marbled Lungfish (*Protopterus aethiopicus* – **Figure 3.4.3**) contains $\sim\{133\} \times \{10^9\}$ DNA bases, (~ 45 times as much as a human) and a fresh water amoeboid, *Polychaos dubium*, has as much as $\{670\} \times \{10^9\}$ bases ($\{200\} \times$ a human).



Figure 3.4.3 Marbled Lungfish (*Protopterus aethiopicus*) has a genome of $\sim 133 \times 10^9$ base pairs, which is $\sim 45X$ that of a human. It is an example of the C-value paradox.

Table 3.4.1 Measures of genome size in selected organisms. The DNA content (1C) is shown in millions of base pairs (Mb). For eukaryotes, the chromosome number is the chromosomes counted in a gamete (1N) from each organism. The average gene density is the mean number of non-coding bases (in bp) between genes in the genome.

Organism	DNA Content (Mb, 1C)	Estimated Gene Number	Average Gene Density	Chromosome Number (1N)
<i>Homo sapiens</i>	3,200	25,000	100,000	23
<i>Mus musculus</i>	2,600	25,000	100,000	20
<i>Drosophila melanogaster</i>	140	13,000	9,000	4
<i>Arabidopsis thaliana</i>	130	25,000	4,000	5
<i>Caenorhabditis elegans</i>	100	19,000	5,000	6
<i>Saccharomyces cerevisiae</i>	12	6,000	2,000	16
<i>Escherichia coli</i>	5	3,200	1,400	1

The c-Value Paradox

This apparent paradox (called the **C-value paradox**) can be explained by the fact that not all nuclear DNA encodes genes – much of the DNA in larger genomes is non-gene coding. In fact, in many organisms, genes are separated from each other by long stretches of DNA that do not code for genes or any other genetic information. Much of this “non-gene” DNA consists of transposable elements of various types, which are an interesting class of self-replicating DNA elements. Other non-gene DNA includes short, highly repetitive sequences of various types. Together, this non-functional DNA is often referred to as “Junk DNA”.

The “Onion Test”

This “test” deals with any proposed explanation for the function(s) of non-coding (junk) DNA. For any proposed function for the excess of DNA in eukaryote genomes (c-value paradox), can it “explain why an onion needs about five times more non-coding DNA for this function than a human?” The onion, *Allium cepa*, has a haploid genome size of ~17 pg, while humans have only ~3.5 pg. Why? Also, onion species range from 7 to 31.5 pg, so why is there this range of genome size in organisms of similar complexity?

The term “onion test” was first coined in April 2007 by T. Ryan Gregory, the Canadian evolutionary biologist and genome biologist. For an interesting alternative view of the onion test, see Jonathan McLatchie’s (2011) article, [“Why the ‘Onion Test’ Fails as an Argument for ‘Junk DNA’”](#) on the Evolution News website.

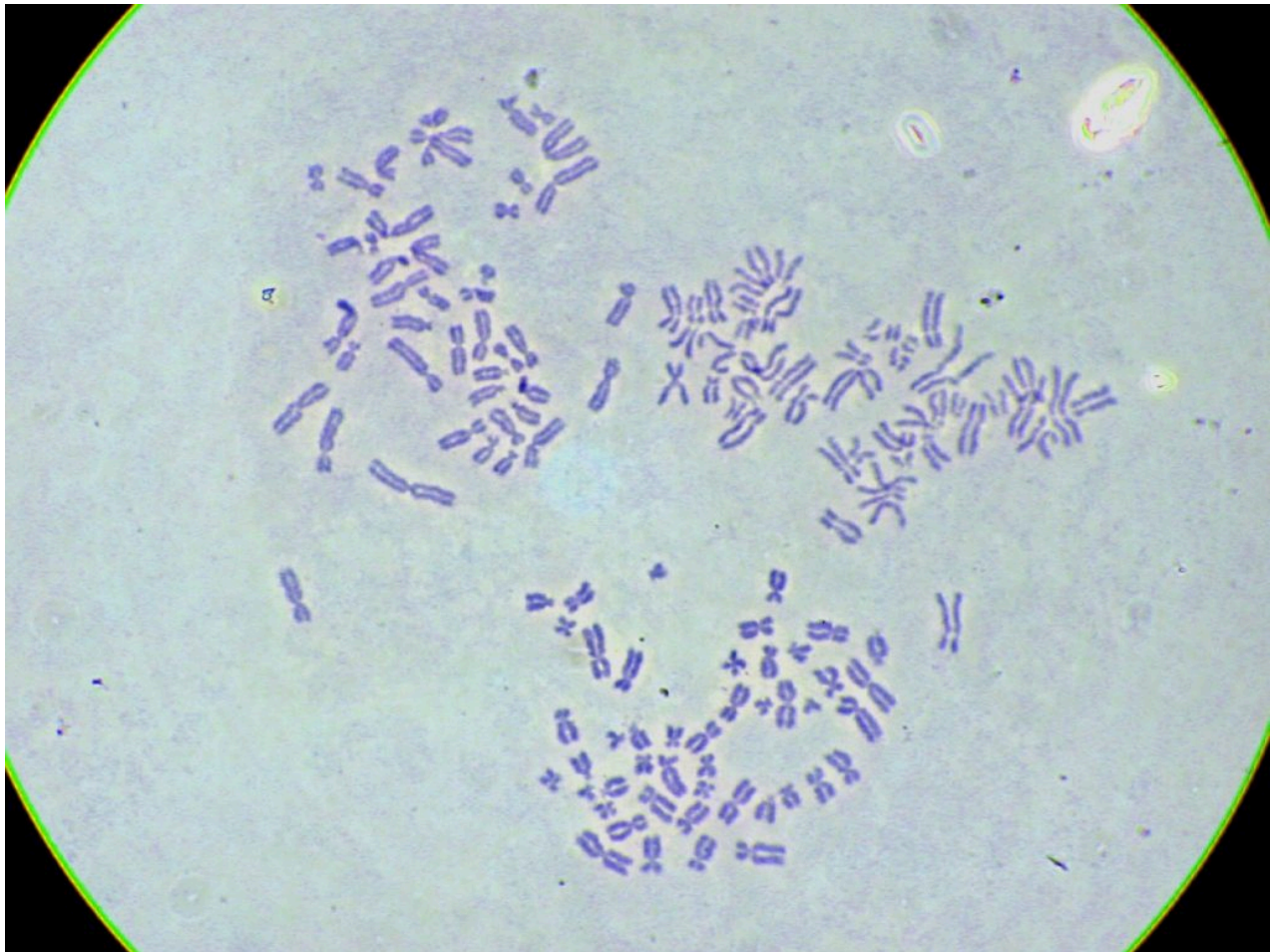

Figure 3.4.4 Human Metaphase Chromosome Spreads. To make these figures, white blood cells in metaphase were dropped onto a slide. The cells burst open and the chromosomes can then be stained with giemsa (a purple colour). This image shows chromosomes from three cells that hit the slide close to one another. They can be distinguished by the size difference among the chromosome sets, which is due to the differences in condensation during the stages of mitosis (prophase). [[Long description](#)]

To calculate how much DNA is seen in the nuclei in **Figure 3.4.4**, consider that a human gamete has about 3000 million base pairs. We can shorten this statement to $1c = 3000 \text{ Mb}$ where c is the **c-value**, the DNA content in a gamete. When an egg and sperm join the resulting zygote is $2c = 6000 \text{ Mb}$. Before the zygote can divide and become two cells it must undergo DNA replication. This doubles the DNA content to $4c = 12\,000 \text{ Mb}$. When the zygote divides, each daughter cell inherits half the DNA and is therefore back to $2c = 6000 \text{ Mb}$. Then each cell will become $4c$ again (replication) before dividing themselves to become $2c$ each. From this point forward, every cell in the embryo will be $2c = 6000 \text{ Mb}$ before its S phase and $4c = 12\,000 \text{ Mb}$ afterwards. The same is true for the cells of fetuses, children, and adults. Because the cells used to prepare this chromosome spread were adult cells in metaphase each is $4c = 12\,000 \text{ Mb}$. Note, there are some rare exceptions, such as some stages of meocytes that make germ cells and other rare situations like the polyploidy of terminally differentiated liver cells.

In summary:

Table 3.4.2 c-Values in Human Cells

Human Cell	DNA Content
gamete (egg or sperm)	1c = 3000 Mb
regular cell before S phase	2c = 6000 Mb
regular cell after S phase	4c = 12 000 Mb

The Number of Chromosomes (n-Value)

Human gametes contain 23 chromosomes. We can summarize this statement as $1n = 23$ where n is the **n-value**, the number of chromosomes in a gamete. When a $1n = 23$ sperm fertilizes a $1n = 23$ egg, the zygote will be $2n = 46$. But, unlike DNA content (c), the number of chromosomes (n) does *not* change with DNA replication. A replicated chromosome is still just one chromosome. Thus, the zygote stays $2n = 46$ after S phase. When the zygote divides into two cells, both contain 46 chromosomes and are still $2n = 46$. Every cell in the embryo, fetus, child, and adult is also $2n = 46$ (with the exceptions noted above).

In summary:

Table 3.4.3 n-Values in Human Cells

Human Cell	Chromosome Number
gamete (egg or sperm)	$1n = 23$
regular cell before S phase	$2n = 46$
regular cell after S phase	$2n = 46$

Note that in a normal cell, the chromosome number is $2n$ before and after chromosome replication. The n -value does not change while the c -value does.

Media Attributions

- **Figure 3.4.1 Original** by M. Deyholos/L. Canham (2017), [CC BY-NC 3.0](#), Open Genetics Lectures
- **Figure 3.4.2 Mitosis cell division** by Schoolbag.info, [CC BY-SA 4.0](#), via Wikimedia Commons
- **Figure 3.4.3 Marbled lungfish 1** by [OpenCage](#), [CC BY 2.5](#), via Wikipedia
- **Figure 3.4.4 Original** by Alexander Smith (2017), [CC BY-NC 3.0](#), Open Genetics Lectures

References

McLatchie, J. (2011, November 2). Why the “Onion Test” Fails as an Argument for “Junk DNA”. *Evolution News*.
https://evolutionnews.org/2011/11/why_the_onion_test_fails_as_an/

Deyholos, M., & Canham, L. (2017). Figure: 4. Changes in DNA and chromosome content ... [diagram]. In Locke, J., Harrington, M., Canham, L. and Min Ku Kang (Eds.), *Open Genetics Lectures, Fall 2017* (Chapter 14, p. 3). Dataverse/

BCcampus. http://solr.bccampus.ca:8001/bcc/file/7a7b00f9-fb56-4c49-81a9-cfa3ad80e6d8/1/OpenGeneticsLectures_Fall2017.pdf

Smith, A. (2017). Figure 1. Human metaphase chromosome spreads [micrograph image]. In Locke, J., Harrington, M., Canham, L. and Min Ku Kang (Eds.), *Open Genetics Lectures, Fall 2017* (Chapter 15, p. 1). Dataverse/ BCcampus. http://solr.bccampus.ca:8001/bcc/file/7a7b00f9-fb56-4c49-81a9-cfa3ad80e6d8/1/OpenGeneticsLectures_Fall2017.pdf

Long Descriptions

- **Figure 3.4.1** A linear schematic showing simple circles to represent cells used to demonstrate the changes in DNA and chromosome content during the cell cycle and mitosis. The DNA content of cells is represented by simple black lines. The image starts with gametes containing a haploid number of two, and upon fertilization, a cell is produced which contains a diploid number (four). During the S or synthesis phase, DNA content is doubled, represented by four pairs of black lines. Finally, after meiosis, two daughter cells are produced, each containing the diploid number depicted by four black lines in each cell. [Back to [Figure 3.4.1](#)]
- **Figure 3.4.2** The various stages of mitosis and the changes in chromosomes that occur are shown as follows: In the initial interphase stage, the DNA exists as diffuse chromatin, and the nuclear membrane is intact. Following this, the cell is shown to be in prophase, with condensed chromosomes and disappearing nuclear envelope. The cell then goes through the stage of metaphase, and chromosomes are shown lined up on the equator of the cell. Anaphase follows, whereby the chromatids are being pulled apart to the poles of the cell. Telophase follows, with a nuclear envelope reforming around the pulled-apart chromatids. Finally, after cytokinesis, two daughter cells are shown, each containing the diploid number of chromosomes. [Back to [Figure 3.4.2](#)]
- **Figure 3.4.4** Purple-stained chromosomes, derived from three different white blood cells, are shown with each cell presenting the Metaphase stage of division. All chromosomes are shown to be replicated, with small differences in the condensation of the chromosomes, resulting in varying thicknesses of the chromosomes. [Back to [Figure 3.4.4](#)]

3.5 Appearance of a Typical Nuclear Chromosome During the Cell Cycle

If we follow a typical chromosome in a typical human cell, it alternates between unreplicated and replicated states, and between relatively uncondensed and condensed. The replication is easy to explain. If a cell has made the commitment to divide, it first needs to replicate its DNA. This occurs during S phase. Before S phase, chromosomes consist of a single piece of double-stranded DNA and after they consist of two identical double-stranded DNA molecules.

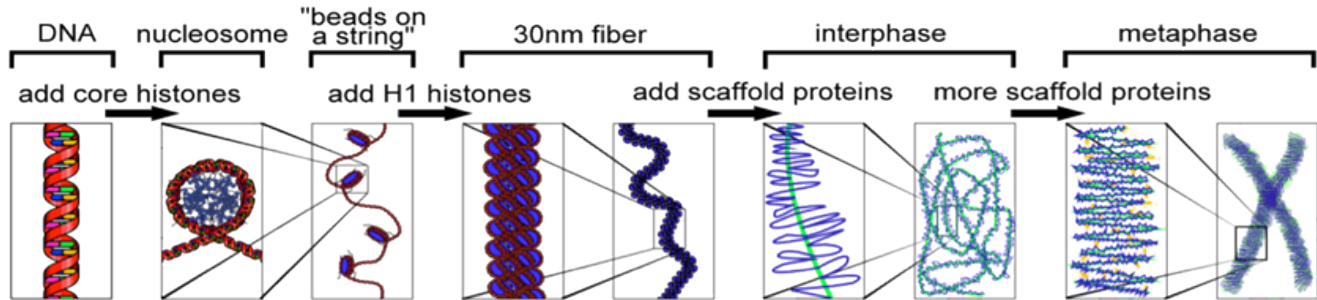

Figure 3.5.1 Successive Stages of Chromosome Condensation Depend on the Introduction of Additional Proteins. [[Long description](#)]

The condensation is a more complex story because eukaryotic DNA is always wrapped around some proteins. **Figure 3.5.1** shows the different levels commonly found in cells. During interphase, a chromosome exists mostly as a **30 nm fibre**. This allows it to fit inside the nucleus and still have the DNA be accessible for enzymes performing RNA synthesis, DNA replication, and DNA repair. At the start of mitosis, these processes halt and the chromosome becomes even more condensed. This is necessary so that the chromosomes are compact enough to move to the opposite ends within the cell. When mitosis is complete the chromosome returns to its 30 nm fibre structure. Recall that each of our cells has a maternal and a paternal chromosome 1. **Figure 3.5.2** shows what these chromosomes look like during the cell cycle.

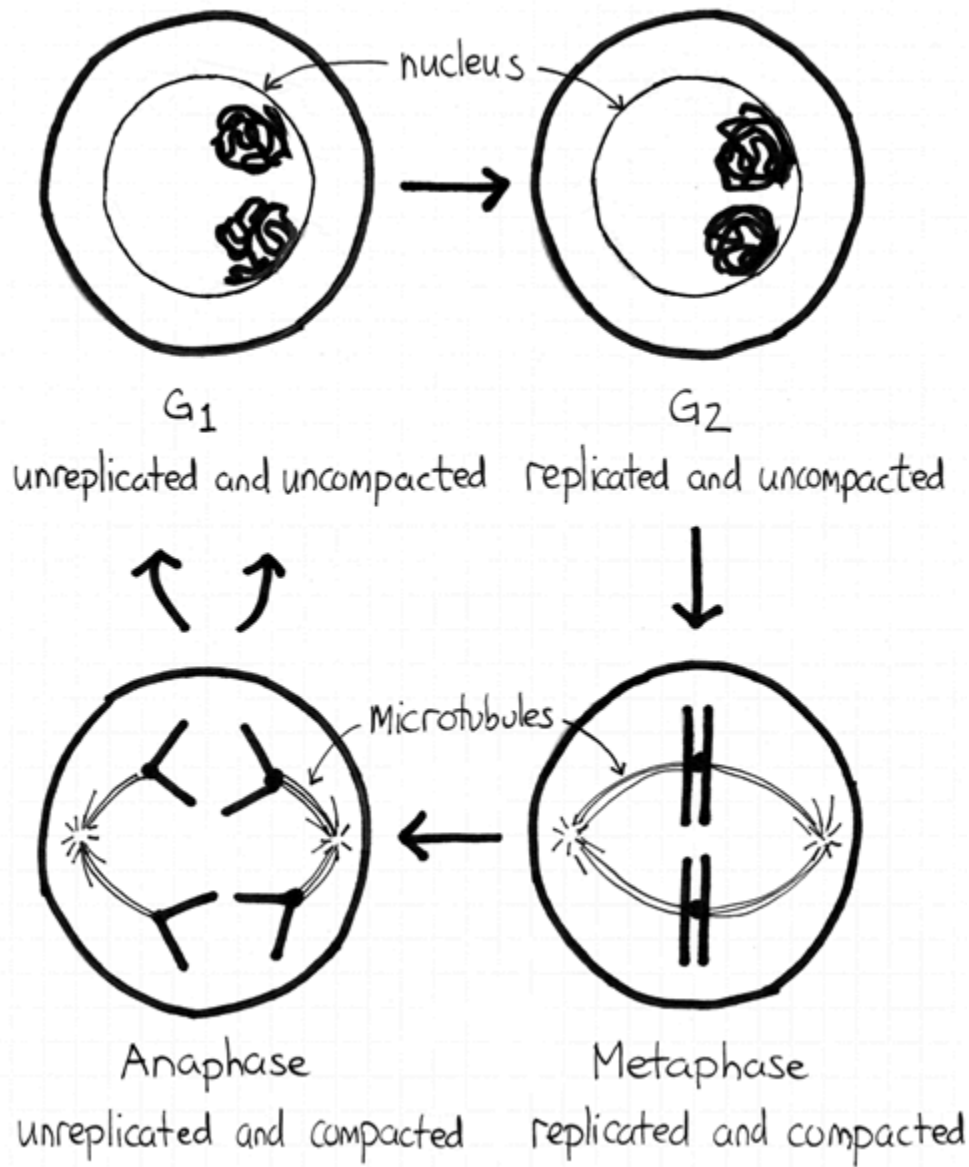

Figure 3.5.2 Appearance of Maternal and Paternal Chromosome 1 During the Cell Cycle. The other 44 chromosomes are not shown. Note that they are independent during both interphase (top) and mitosis (bottom). After anaphase there will be two cells in G₁. [[Long description](#)]

Media Attributions

- **Figure 3.5.1** [Chromatin Structures](#) by [Richard Wheeler](#) at [en.wikipedia](#), [CC BY-SA 3.0](#), via Wikipedia
- **Figure 3.5.2** [Original](#) by M. Harrington (2017), [CC BY-NC 3.0](#), MRU Open Genetics Lectures

Reference

Harrington, M. (2017). Figure 8. Appearance of maternal and paternal chromosome 1 ...[diagram]. In Locke, J., Harrington, M., Canham, L. and Min Ku Kang (Eds.), *Open Genetics Lectures, Fall 2017* (Chapter 15, p. 6). Dataverse/ BCcampus. http://solr.bccampus.ca:8001/bcc/file/7a7b00f9-fb56-4c49-81a9-cfa3ad80e6d8/1/OpenGeneticsLectures_Fall2017.pdf

Long Descriptions

- **Figure 3.5.1** The various levels of chromosome compaction and architecture in a cell are depicted as follows: A DNA double helix is followed by the combination of DNA and core histones, then the beads-on-a-string structure, followed by more histone additions, to form the 30nm fiber. This is then combined with scaffolding proteins to eventually result in the typically shaped and presented chromosome. [Return to [Figure 3.5.1](#)]
- **Figure 3.5.2** The appearance of chromosomes during the G1 and G2 growth stages of the cell cycle is different from chromosomes in the anaphase and metaphase of mitosis. During the growth phases, the chromosomes are unreplicated and uncompact, compared to anaphase and metaphase, where the chromosomes are compacted and condensed, and spindle fibres are shown to be present in the cell during these stages of mitosis. [Return to [Figure 3.5.2](#)]

3.6 Compare and Contrast Mitosis and Meiosis

Here, we outline the differences between mitosis and meiosis in humans (Diploid #46). Knowing the differences between these fundamental cell processes is an important foundation in your understanding of genetics for the rest of the course.

Table 3.6.1 Differences between Mitosis and Meiosis in Humans (Diploid #46)

Cell Processes	Mitosis	Meiosis
Creates	all the cells in your body except sex cells	sex cells only; Female egg cells or Male sperm cells
Definition	process of cell division that forms two new cells (daughter cells), each of which has the same number of chromosomes	process in cell division during which four new cells are created each with half the original number of chromosomes, which results in the production of sex cells
End Products	2 daughter cells	4 daughter cells
Steps	Interphase, Prophase, Metaphase, Anaphase, Telophase	Interphase, Prophase I, Metaphase I, Anaphase I, Telophase I, Prophase II, Metaphase II, Anaphase II, Telophase II
Type of Reproduction	asexual	sexual
Are they identical to the parent cell?	Yes, they are identical	No, they are different since they have half the number of chromosomes as the original
When does cytokinesis occur?	occurs in Telophase	occurs in Telophase I, and Telophase II
How many times does the parent cell divide?	1	2
What happens to the number of chromosomes at the end of each process? Are they in pairs or individual chromosomes?	Identical to parent; Individual chromosomes	½ chromosomes as parent; individual chromosomes
Why is each important?	Needed to repair damaged body, create new body cells, for growth, and to replace cells that have died	Needed to create sex cells required for sexual reproduction to create a new organism, and for variation within a population
How many chromosomes do human body cells and human sex cells have after they go through each process?	46	23

Take a look at the following video, *Mitosis vs. Meiosis*, by Beverly Biology (2014) on YouTube, which compares and contrasts mitosis and meiosis.

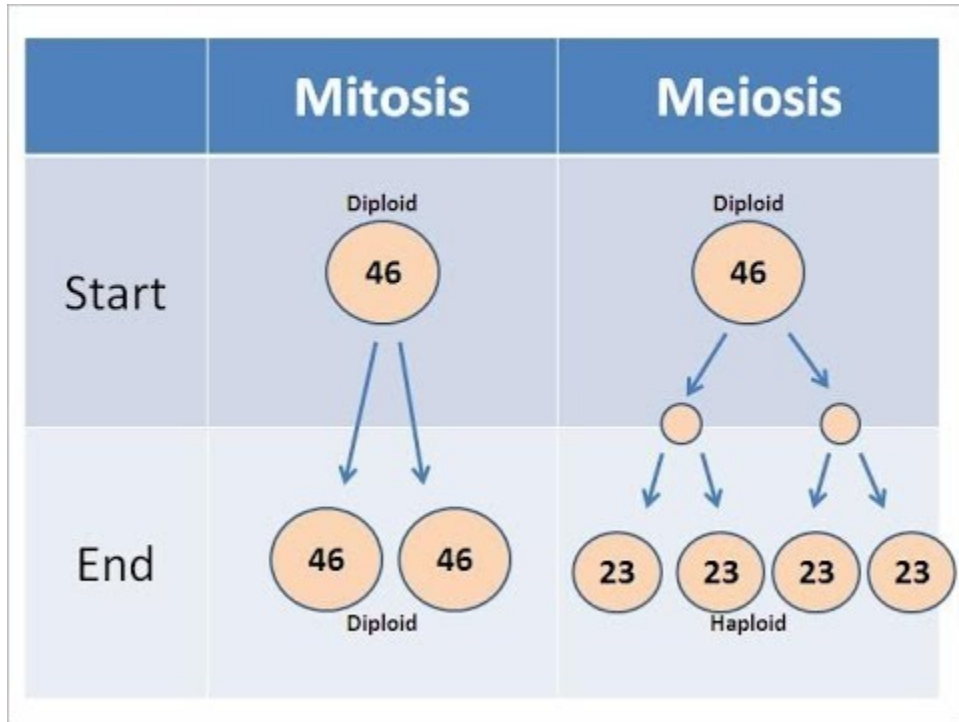

A YouTube element has been excluded from this version of the text. You can view it online here:

<https://opengenetics.pressbooks.tru.ca/?p=1341>

Reference

Beverly Biology. (2014, May 3). Mitosis vs. Meiosis (video file). YouTube. <https://www.youtube.com/watch?v=bRcjB1lhDCU>

Chapter 3 Summary

The topics covered in this chapter can be summarized as follows:

- The asexual transmission of genetic information is accomplished in a process called Mitosis.
- The process of mitosis can be divided into Prophase, Metaphase, Anaphase, and Telophase.
- Mitosis reduces the c-number, but not the n-number of the daughter cells.
- Not all the DNA in an organism codes for genes. In most higher eukaryotes most DNA is non-gene coding and appears to have no specific function and is called “junk” DNA.
- The c-value paradox refers to the observation that the amount of DNA is not necessarily related to the complexity of the organism.
- The c-value is the amount of DNA in a gamete. Humans are $1c = 3000$ Mb.
- The n-value is the number of chromosomes in a gamete. Humans are $1n = 23$.
- A typical cell in your body is $2c = 6000$ Mb and $2n = 46$ before DNA replication and $4c = 12\ 000$ Mb and $2n = 46$ after.

Key Terms in Chapter 3

Key Terms – Mitosis and the Cell Cycle

- anaphase
- chromatids
- c-value paradox
- c-value
- cytokinesis
- G₀ Phase
- G₁ Phase
- G₂ Phase
- interphase
- kinetochore
- M Phase
- metaphase plate
- metaphase
- microtubules
- mitosis
- nuclear genome
- n-value
- prophase
- replicated chromosome
- S Phase
- telophase
- unreplicated chromosome

Chapter 3 Study Questions

1. Species A has $n=4$ chromosomes and Species B has $n=6$ chromosomes. Can you tell from this information which species has more DNA? Can you tell which species has more genes?
2. The answer to question 1 implies that not all DNA within a chromosome encodes genes. Can you name any examples of chromosomal regions that contain relatively few genes
 - a. How many centromeres does a typical chromosome have?
 - b. What would happen if there was more than one centromere per chromosome?
 - c. What if a chromosome had no centromeres?
3. For a diploid organism with $2n=16$ chromosomes, how many chromosomes and chromatids are present per cell at the end of:
 - a. G_1
 - b. S
 - c. G_2
 - d. mitosis
4. Refer to [Table 3.4.1](#).
 - a. What is the relationship between DNA content of a genome, number of genes, gene density, and chromosome number?
 - b. What feature of genomes explains the c-value paradox?
 - c. Do any of the numbers in this Table show a correlation with organismal complexity?

Chapter 3 Answers

1. Since chromosomes vary greatly in size, the number of chromosomes does not correlate with the total DNA content. For reasons discussed in Chapter 5 and this chapter, the number of genes does not correlate closely to DNA content either.
2. Heterochromatic regions with repetitive DNA, centromeres, and telomeres are examples of gene-poor regions of chromosomes.
 - a. Only one (except for holocentric chromosomes, not discussed in this chapter).
 - b. The two centromeres might get pulled towards opposite poles at mitosis/meiosis resulting in chromosome breakage.
 - c. It would not segregate properly at mitosis or meiosis, leading to aneuploidy. In order to segregate correctly, there would have to be another way to control its movement at mitosis and meiosis.
3.
 - a. At the end of G₁, 16 chromosomes with 1 chromatid each.
 - b. At the end of S, 16 chromosomes with 2 chromatids each.
 - c. At the end of G₂, 16 chromosomes with 2 chromatids each.
 - d. At the end of mitosis, 16 chromosomes with 1 chromatid each.
4.
 - a. There is little correlation between any of these, with the exception that larger genomes tend to have more genes.
 - b. The C-value paradox can be explained by genomes having different amounts of non-coding DNA between genes and within genes as introns.
 - c. If we define “organismal complexity” as the size of the genome (or number of cells/organism), then larger, more complex organisms tend to have more genes although not always and not in a direct, linear, proportioned manner. Also, those with larger genomes tend to have greater distances between genes.

CHAPTER 4 - PEDIGREE ANALYSIS

4.1 Introduction

Learning Objectives

- Identify and use the symbols found in Pedigree Charts.
- Analyze Pedigree Charts to determine the genotypes and phenotypes of individuals in the chart.
- Identify the pattern of inheritance of autosomal dominant and recessive traits in humans.
- Relate the chromosome theory of inheritance to Mendelian principles.

In [Chapter 1](#), we discussed “model genetic organisms” – these are organisms with characteristics that make them useful for genetic analysis. Such as, short generation time, production of numerous progeny, and the ability to be reared in a laboratory environment. Humans are not model genetic organisms; there are no pre-breeding lines, controlled matings are not possible, generation time is relatively long, and progeny numbers are too small to conduct statistical analyses on. Some techniques, such as test crosses, can only be performed with model organisms or other species that can be experimentally manipulated. As such, we are unable to perform controlled crosses with humans, and therefore, in order to be able to study the pattern of inheritance of traits in humans, we look at either a large number of families or several generations within a large family.

To study the inheritance patterns of genes in humans and other species for which controlled matings are not possible, geneticists use the analysis of **pedigrees** and populations.

A Pedigree is a pictorial representation of a family history or a family tree, which outlines the inheritance of one or more characteristics.

Many traits which run in human families do not exhibit a simple pattern of Mendelian inheritance. This is usually because these traits are coded for by more than one gene. Conversely, traits that are governed by one gene are typically an abnormality that is life-threatening or debilitating – e.g., [Huntington's Disease](#) (caused by a dominant allele) and [Cystic Fibrosis](#) (caused by a recessive allele). From a methodical analysis of pedigree charts, we can determine if a particular trait is encoded for by different alleles of a particular (single) gene, as well as if the single-trait gene is recessive or dominant. We may also be able to determine if a trait is autosomal or sex-linked.

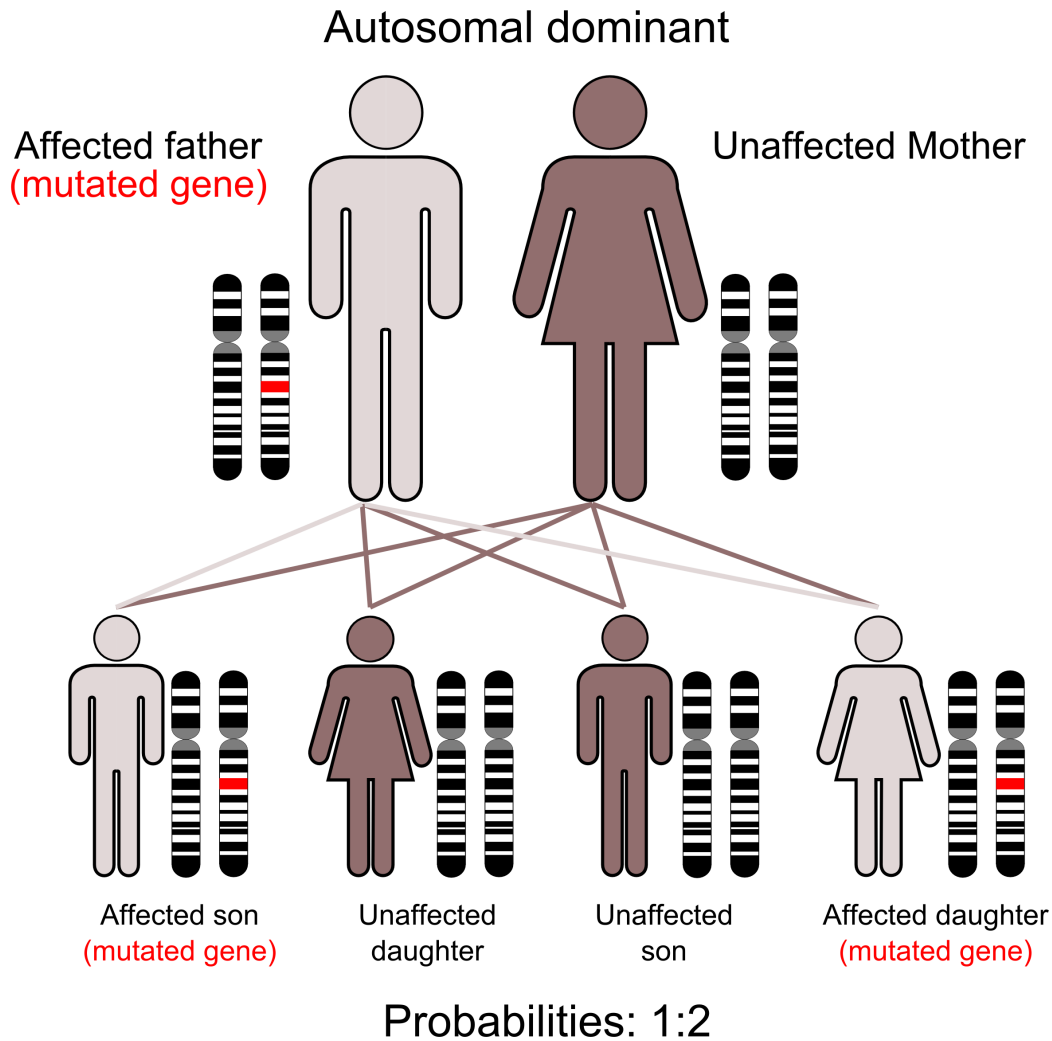

Figure 4.1.1 Inheritance of an Autosomal Dominant Trait, such as Huntington's Disease [[Long description](#)]

Media Attributions

- **Figure 4.1.1** [Autodominant en 01](#) by Armin Kübelbeck, [CC BY-SA 3.0](#), via Wikimedia Commons

References

- Mayo Clinic Staff. (n.d.). Cystic Fibrosis. MayoClinic.org (accessed January 18, 2022). <https://www.mayoclinic.org/diseases-conditions/cystic-fibrosis/symptoms-causes/syc-20353700>
- Mayo Clinic Staff. (n.d.). Huntington's disease. MayoClinic.org (accessed January 18, 2022). <https://www.mayoclinic.org/diseases-conditions/huntingtons-disease/symptoms-causes/syc-20356117>

Long Description

- **Figure 4.1.1** Inheritance of an autosomal dominant trait. Two parents are shown: male possesses the mutated gene, and female is unaffected. Their offspring are outlined, whereby they produce one affected son with the mutated gene, one unaffected son, an unaffected daughter, and finally, an affected daughter with the mutated gene. Alongside each individual is an image of the pair of homologous chromosomes which contains the gene loci for the trait under consideration. Affected individuals are shown via a red shading of the mutated gene locus on an otherwise black and white image of the homologous chromosomes. [[Back to Figure 4.1.1](#)]

4.2 Symbols used in Pedigree Charts

Pedigree charts are diagrams that show the phenotypes and/or genotypes for a particular organism, its ancestors, and descendants.

In order to glean useful information from a Pedigree Chart, the signs and symbols used to construct the chart must be properly recognized and interpreted. Sufficient information must be given via the Chart, and sometimes, supplementary information is also required (e.g., the frequency at which the particular trait is found in the population from which the family is derived). Geneticists use a standardized set of symbols to represent an individual's sex, family relationships, and phenotype. These diagrams are used to determine the **mode of inheritance** of a particular disease or trait, and to predict the probability of its appearance among offspring. Pedigree analysis is therefore an important tool in basic research, agriculture, and **genetic counselling**.

Each pedigree chart represents all the available information about the inheritance of a single trait (most often a disease) within a family. The pedigree chart is therefore drawn using phenotypic information, but there is always some possibility of errors in this information, especially when relying on family members' recollections or even clinical diagnoses. In real pedigrees, further complications can arise due to **incomplete penetrance** (including age of onset) and **variable expressivity** of disease alleles, but for the examples presented in this book, we will presume complete accuracy of the pedigrees – that is, the phenotype accurately reflects the genotype. A pedigree may be drawn when trying to determine the nature of a newly discovered disease, or when an individual with a family history of a disease wants to know the probability of passing the disease on to their children. In either case, a tree is drawn, as shown in **Figure 4.2.1**, with circles to represent females, and squares to represent males. Matings are drawn as a line joining a male and female, while a consanguineous mating (closely related) is two lines.

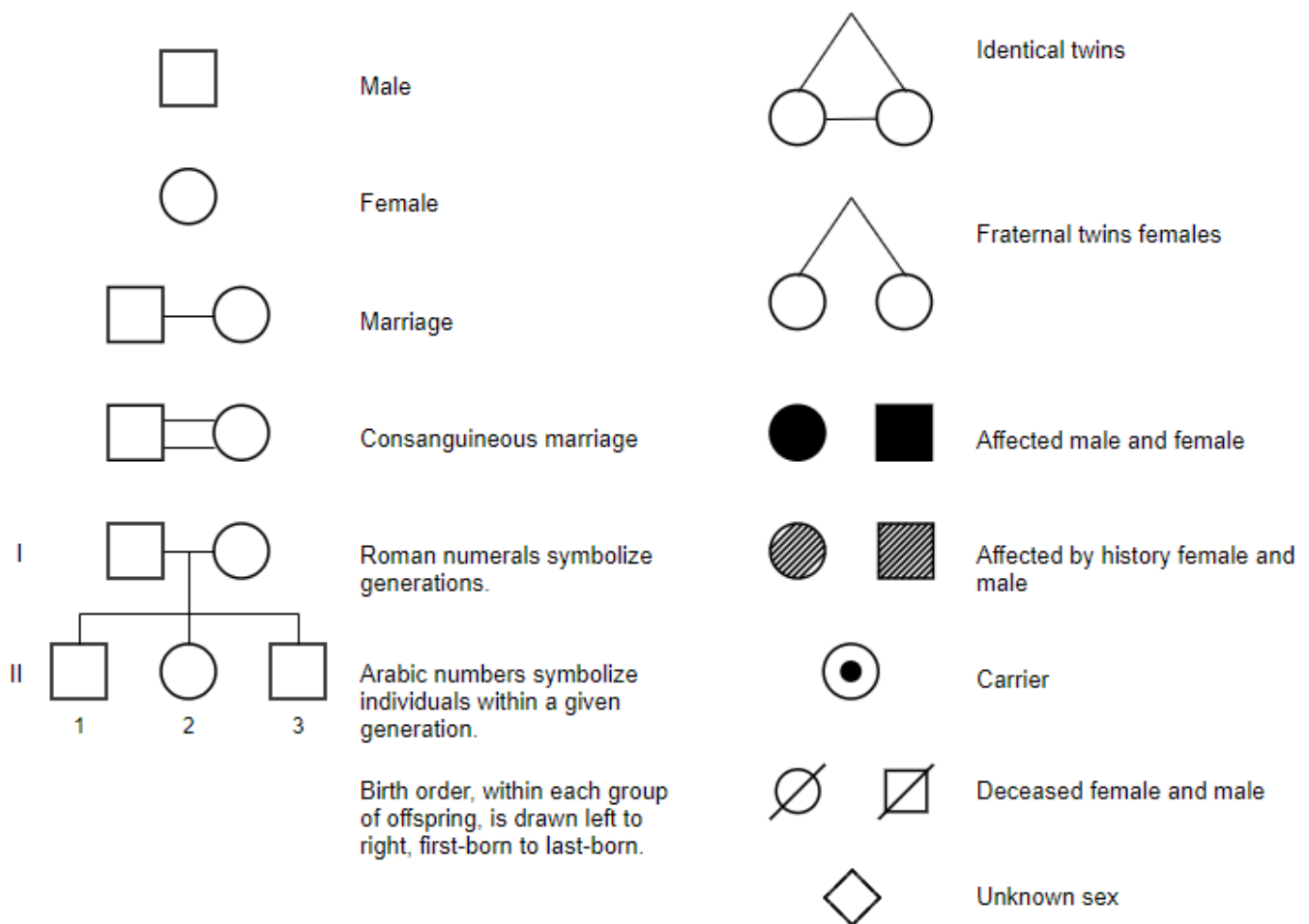

Figure 4.2.1 Symbols Used in Constructing a Pedigree Chart [[Long description](#)]

The affected individual that brings the family to the attention of a geneticist is called the **proband** (or propositus). If the individual is unaffected, they are called the consultand. If an individual is known to have symptoms of the disease (**affected**), the symbol is filled in. Sometimes, a half filled-in symbol is used to indicate a known **carrier** of a disease; this is someone who does not have any symptoms of the disease, but who passed the disease on to subsequent generations because they are a heterozygote. Female carriers of X-linked traits are indicated by a circle with a dot in the centre. Note, that when a pedigree is constructed, it is often unknown whether a particular individual is a carrier or not, so not all carriers are always explicitly indicated in a pedigree. For simplicity, in this chapter we will assume that the pedigrees presented are accurate, and represent fully penetrant traits. If possible, the male partner should be left of female partner on relationship line. Siblings should be listed from left to right in birth order, oldest to youngest.

Media Attributions

- **Figure 4.2.1** Symbols used in constructing a pedigree chart by John Locke (2019), [CC BY-NC-SA 3.0](#)

Long Description

- **Figure 4.2.1** Symbols are used to construct pedigree charts. The major ones are as follows: male – square; female – circle; marriage – square and circle linked by a horizontal line; affected male – shaded square; affected female – shaded circle; carrier – circle or square with a dot inside; deceased – circle or square with a line running through it; unknown sex – a diamond; Roman numerals symbolize generations, and Arabic numbers symbolize individuals within a given generation; birth order within each group of offspring is drawn left to right, from first-born to last-born. [Back to [Figure 4.2.1](#)]

4.3 Modes of Inheritance

Usually, we are presented with a pedigree of an uncharacterized disease or trait, and one of the first tasks is to determine which modes of inheritance are possible, and then, which mode of inheritance is most likely. This information is essential in calculating the probability that the trait will be inherited in any future offspring. We will mostly consider five major types of inheritance: autosomal dominant (AD), autosomal recessive (AR), X-linked dominant (XD), X-linked recessive (XR), and Y-linked (Y) inheritance.

We generally make two assumptions in analyzing Pedigree Charts. These are as follows:

1. **Complete Penetrance** – an individual in the pedigree will be affected (express the phenotype associated with a trait) when the individual carries at least one dominant allele of a dominant trait, or two recessive alleles of a recessive trait.
2. **Rare-in-Population** – generally, the trait in question is rare in the general population.

The following are some hints and clues to help us interpret Pedigree Charts:

1. An unaffected individual cannot have any alleles of a dominant trait (because a single allele of a dominant trait causes an individual to be affected).
2. Individuals marrying into the family are assumed to have no disease alleles – they will never be affected and can never be carriers of a recessive trait (because the trait is rare in the population).
3. An unaffected individual can be a carrier (have one allele) of a recessive trait (because two alleles of a recessive trait are required for an individual to be affected).
4. When a trait is X-linked, a single recessive allele is sufficient for a male to be affected (because the male is hemizygous – he only has one allele of an X-linked trait).
5. A father transmits his allele of X-linked genes to his daughters, but not his sons. A mother transmits an allele of X-linked genes to both her daughters and her sons.

Take a look at the following video, *Pedigree Analysis*, by AK Lecture Series (2015) on YouTube, which discusses Pedigree Charts and how to analyze them.

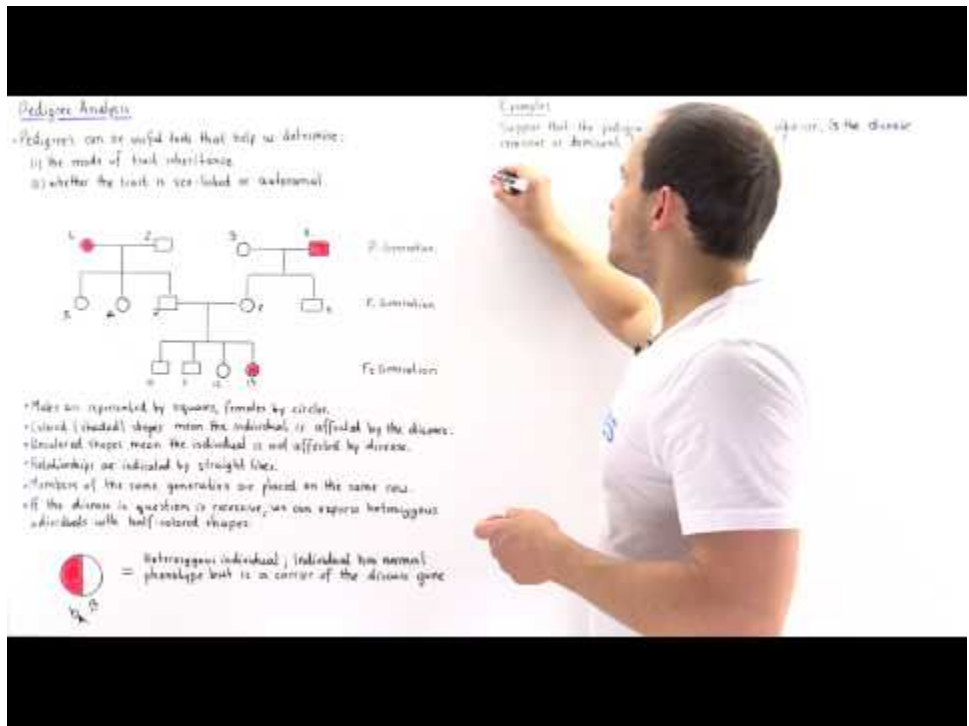

A YouTube element has been excluded from this version of the text. You can view it online here:

<https://opengenetics.pressbooks.tru.ca/?p=547>

Let us now take a look at the various modes of inheritance and typical pedigree charts which are characteristic of each mode.

Autosomal Dominant (AD)

When a disease is caused by a dominant allele of a gene, every person with that allele will show symptoms of the disease (assuming complete penetrance), and only one disease allele needs to be inherited for an individual to be affected. Thus, every affected individual must have an affected parent. A pedigree with affected individuals in every generation is typical of AD diseases. However, beware that other modes of inheritance can also show the disease in every generation, as described below. It is also possible for an affected individual with an AD disease to have a family without any affected children, if the affected parent is a heterozygote. This is particularly true in small families, where the probability of every child inheriting the normal, rather than disease allele is not extremely small. Note that AD diseases are usually rare in populations, therefore affected individuals with AD diseases tend to be heterozygotes (otherwise, both parents would have had to been affected with the same rare disease). Huntington Disease, Achondroplastic dwarfism, and Polydactyly are all examples of human conditions that may follow an AD mode of inheritance.

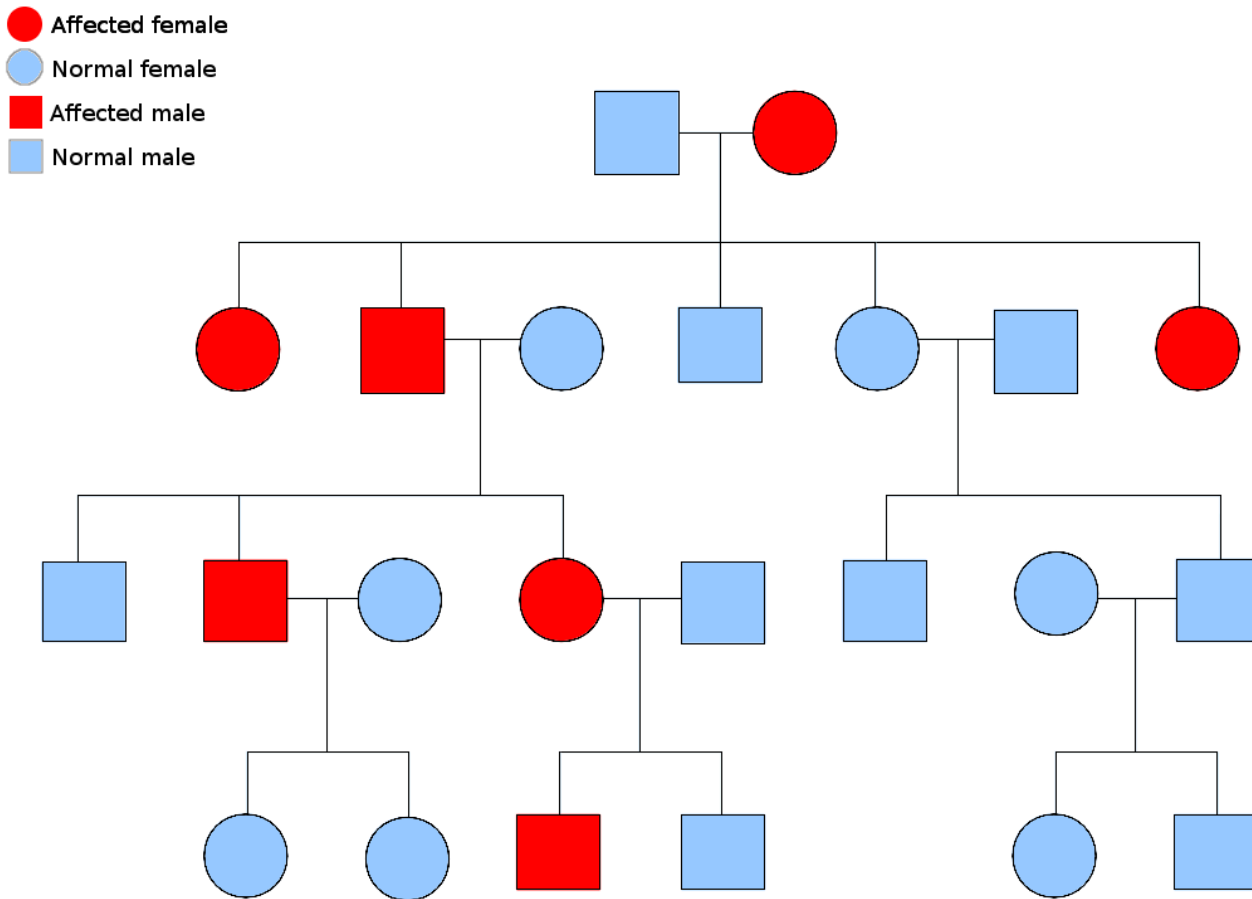

Figure 4.3.1 A Pedigree Chart Showing Autosomal Dominant Inheritance [[Long description](#)]

Example: Achondroplasia is a common form of dwarfism. *FGFR3* gene at 4p16 (chromosome 4, p arm, region 1, band 6) encodes a receptor protein that negatively regulates bone development. A specific base pair substitution in the gene makes an over-active protein and this results in shortened bones. Achondroplasia is considered autosomal dominant because the defective proteins made in A / a embryos halt bone growth prematurely. A / A embryos do not make enough limb bones to survive. Most, but not all dominant mutations are also recessive lethal. In achondroplasia, the A allele shows dominant visible phenotype (shortness) and recessive lethal phenotype.

X-Linked Dominant (XD)

In X-linked dominant inheritance, the gene responsible for the disease is located on the X-chromosome, and the allele that causes the disease is dominant to the normal allele in females. Because females have twice as many X-chromosomes as males, females tend to be more frequently affected than males in the population. However, not all pedigrees provide sufficient information to distinguish XD and AD. One definitive indication that a trait is inherited as AD, and not XD, is that an affected father passes the disease to a son; this type of transmission is not possible with XD, since males inherit their X chromosome from their mothers.

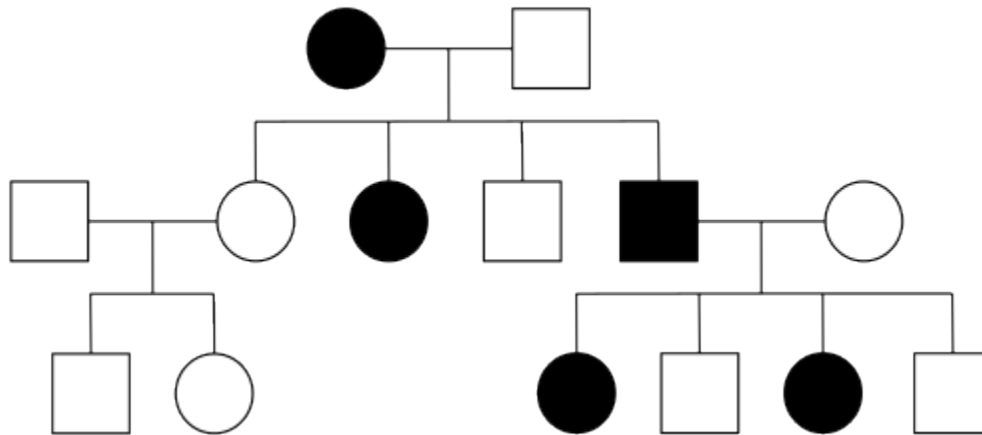

Figure 4.3.2 A Pedigree Consistent with X-Linked Dominant Inheritance [[Long description](#)]

Example: fragile x syndrome – The *FMR1* gene at Xq21 (X chromosome, q arm, region 2, band 1) encodes a protein needed for neuron development. There is a (CGG) n repeat array in the 5'UTR (untranslated region). If there is expansion of the repeat in the germline cell the child will inherit a non-functional allele. X^A / Y males have fragile X mental retardation (IQ < 50) because none of their neurons can make *FMR1* proteins. Fragile X syndrome is considered X-linked dominant because only some neurons in X^A / X^a females can make *FMR1* proteins. The severity (IQ 50 – 70) in these females depends upon the number and location of these cells within in the brain.

Autosomal Recessive (AR)

Diseases that are inherited in an autosomal recessive pattern require that both parents of an affected individual carry at least one copy of the disease allele. With AR traits, many individuals in a pedigree can be carriers, probably without knowing it. Compared to pedigrees of dominant traits, AR pedigrees tend to show fewer affected individuals and are more likely than AD or XD to “skip a generation”. Thus, the major feature that distinguishes AR from AD or XD is that unaffected individuals can have affected offspring. Attached earlobes is a human condition that may follow an AR mode of inheritance.

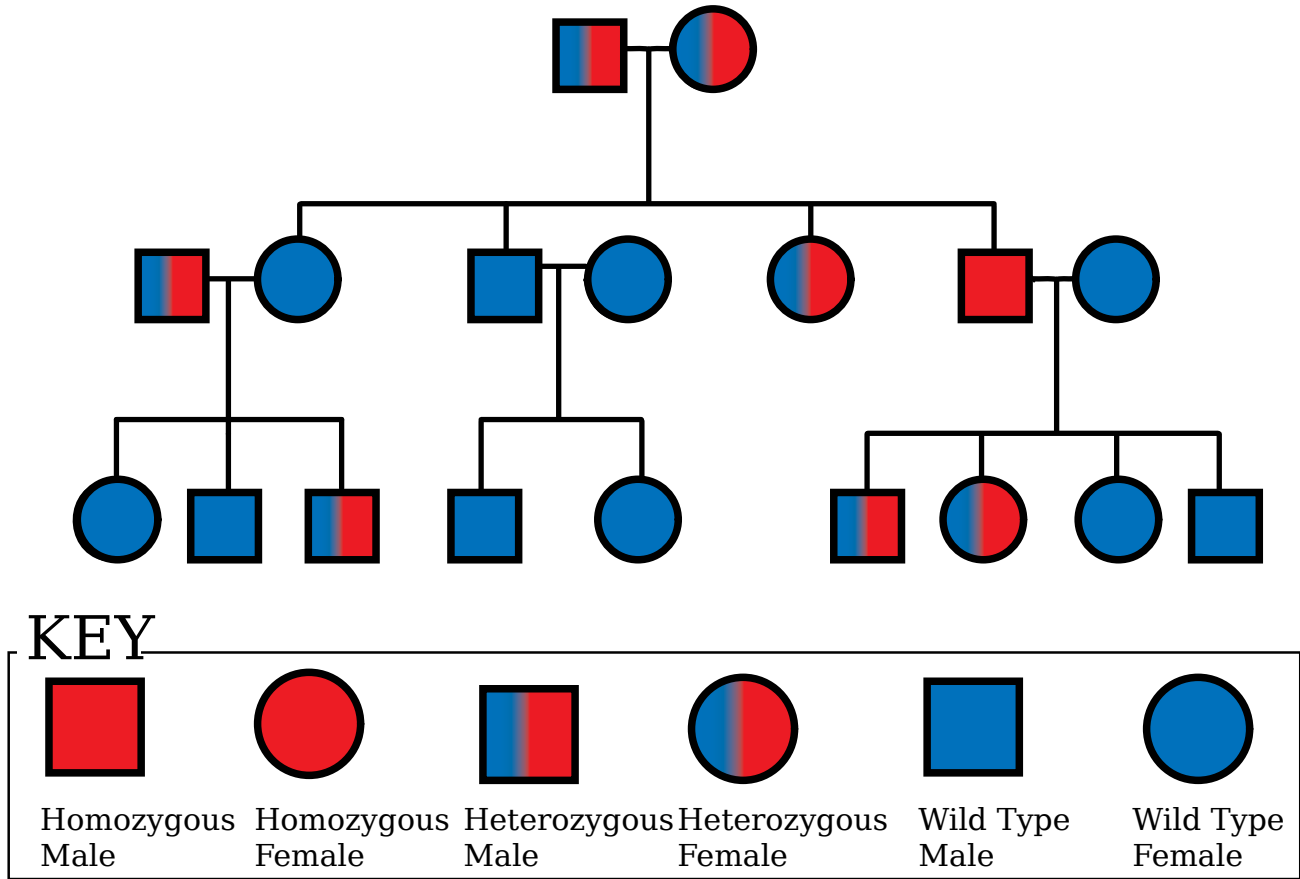

Figure 4.3.3 A Pedigree Consistent with Autosomal Recessive Inheritance [[Long description](#)]

AR example: phenylketonuria (PKU) – Individuals with phenylketonuria (PKU) have a mutation in the PAH gene at 12q24 (chromosome 12, q arm, region 2, band 4), which encodes an enzyme that breaks down phenylalanine into tyrosine called phenylalanine hydrolase (PAH). Without PAH, the accumulation of phenylalanine and other metabolites, such as phenylpyruvic acid, disrupts brain development, typically within a year after birth, and can lead to intellectual disability. Fortunately, this condition is both easy to diagnose and can be successfully treated with a low phenylalanine diet. There are over 450 different mutant alleles of the PAH gene, so most people with PKU are **compound heterozygotes**. Compound heterozygotes have two different mutant alleles (different base pair changes) at a given locus, in this case the PAH gene.

X-Linked Recessive (XR)

Because males have only one X-chromosome, any male that inherits an X-linked recessive disease allele will be affected by it (assuming complete penetrance). Therefore, in XR modes of inheritance, males tend to be affected more frequently than females in a population. This contrasts with AR and AD, where both sexes tend to be affected equally, and XD, in which females are affected more frequently. Note, however, in the small sample sizes typical of human families, it is usually not possible to accurately determine whether one sex is affected more frequently than others. On the other

hand, one feature of a pedigree that can be used to definitively establish that an inheritance pattern is not XR is the presence of an affected daughter from unaffected parents; because she would have had to inherit one X-chromosome from her father, he would also have been affected in XR.

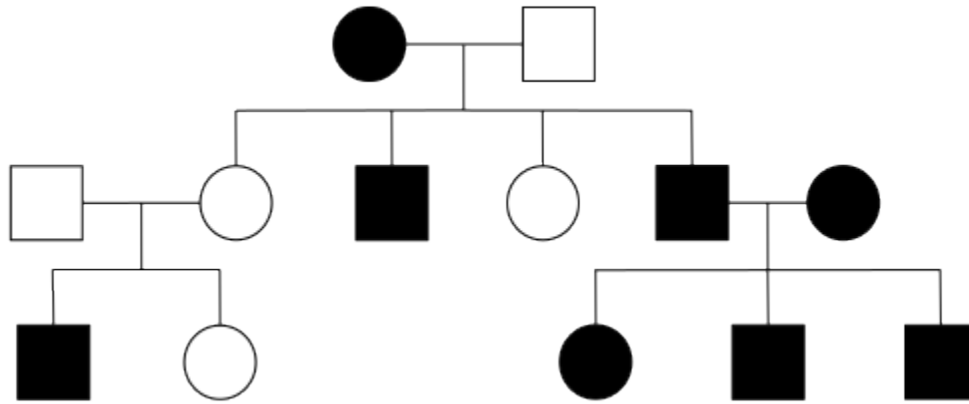

Figure 4.3.4 A Pedigree Consistent with X-Linked Recessive Inheritance [\[Long description\]](#)

XR example: hemophilia A- F8 gene at Xq28 (X chromosome, q arm, region 2, band 8) encodes blood clotting factor VIIIc. Without Factor VIIIc, internal and external bleeding can't be stopped. Back in the 1900s, Xa / Y male's average life expectancy was 1.4 years, but in the 2000s it has increased to 65 years with the advent of Recombinant Human Factor VIIIc. Hemophilia A is recessive because XA / Xa females have normal blood coagulation, while Xa / Xa females have hemophilia.

Y-Linked

Only males are affected in human Y-linked inheritance (and other species with the X/Y sex determining system). There is only father-to-son transmission. This is the easiest mode of inheritance to identify, but it is one of the rarest because there are so few genes located only on the Y-chromosome.

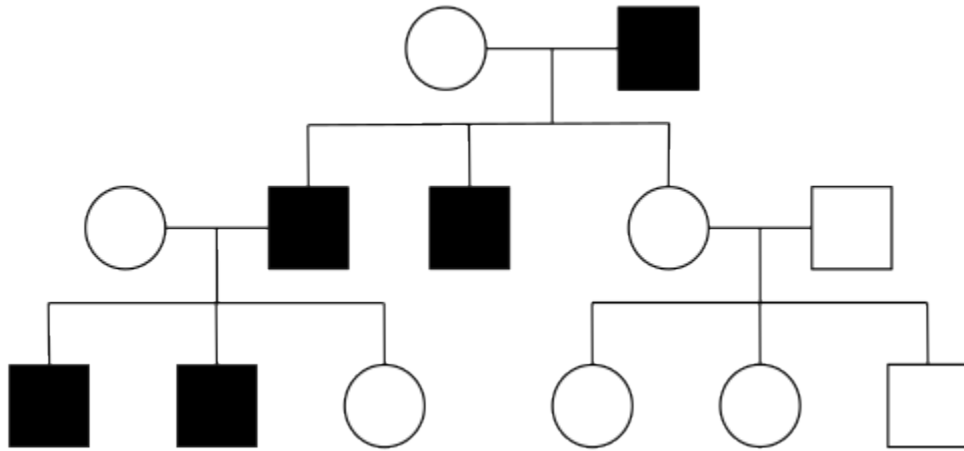

Figure 4.3.5 A Pedigree Consistent with Y-Linked Inheritance [[Long description](#)]

A common, but incorrect, example of Y-linked inheritance is the **hairy-ear-rim** phenotype seen in some Indian families. A better example are the **Y-chromosome DNA polymorphisms** that have been used to follow the male lineage in large families or through ancient ancestral lineages. For example, the Y-chromosome of Mongolian ruler Genghis Khan (1162-1227 CE), and his male relatives, accounts for ~8% of the Y-chromosome lineage of men in Asia (0.5% world wide).

Media Attributions

- **Figure 4.3.1** [Autosomal dominant](#) by Simon Caulton, [CC BY-SA 3.0](#), via Wikimedia Commons
- **Figure 4.3.2** [Wiki Drawing – X-Linked Dominant \(1\)](#) by Madibc68, [CC BY-SA 4.0](#), via Wikimedia Commons
- **Figure 4.3.3** [Autosomal Recessive Pedigree Chart](#) by Jerome Walker, [CC BY-SA 3.0](#), via Wikimedia Commons
- **Figure 4.3.4** [Wiki Drawing – X-Linked Recessive \(1\)](#) by Madibc68, [CC BY-SA 4.0](#), via Wikimedia Commons
- **Figure 4.3.5** [Wiki Drawing – Y-Linked \(1\)](#) by Madibc68, [CC BY-SA 4.0](#), via Wikimedia Commons

Reference

AK Lecture Series. (2015, January 13). Pedigree Analysis (video file). YouTube. https://youtu.be/Wgmt_Ph6Ko

Long Descriptions

- **Figure 4.3.1** Pedigree chart showing inheritance of an autosomal dominant trait over four generations. Affected females are shown as red-coloured circles; normal females are blue-coloured circles; affected males are red-coloured squares; normal males are blue-coloured squares. Generation I begins with a normal male and an affected female, mating to produce five offspring. Their offspring are: two affected and three unaffected. Two of these Generation II individuals mate, and their progeny is shown, along with a final Generation IV, with the characteristic pattern for autosomal dominant traits depicted. [Back to [Figure 4.3.1](#)]

- **Figure 4.3.2** Pedigree chart showing the inheritance of a X-linked dominant trait over three generations. An affected female mates with a normal male in Generation I, to produce four offspring – one normal male, one affected male, one normal female and one affected female. The normal female mates with a normal male, and they produce two unaffected children. The affected male of Generation II mates with a normal female, and they produce four children – two affected females and two unaffected males. This pattern is characteristic for X-linked dominant inheritance. [Back to [Figure 4.3.2](#)]
- **Figure 4.3.3** Pedigree chart showing the inheritance of an autosomal recessive trait, over three generations. Red and blue colours depict differences in the male and female. Both colours mean heterozygous, solid red colour means homozygous recessive, and solid blue color means wild type or homozygous dominant. Generation I begins with two carrier parents, who are therefore heterozygous. They produce four children, two are normal, one is a carrier and one is affected. This pattern is consistent with the inheritance of autosomal recessive traits. [Back to [Figure 4.3.3](#)]
- **Figure 4.3.4** Pedigree chart showing the inheritance of a X-linked recessive trait over three generations. Generation I outlines one affected female and one affected male, mating to produce four children, two unaffected females and two affected males. One of the unaffected females mates with a normal man, and they produce two children: one affected male and an unaffected female. This indicates the unaffected mother was a carrier. This pattern of inheritance is typical of an X-linked recessive trait. [Back to [Figure 4.3.4](#)]
- **Figure 4.3.5** Pedigree chart showing the inheritance of a Y-linked trait. Three generations are shown, starting with a normal female and an affected male, who produce three offspring. Offspring are: one normal female and two affected males. One affected male mates with a normal female, and their offspring comprises one normal female and two affected males. This pattern of inheritance is typical of Y-linked traits. [Back to [Figure 4.3.5](#)]

4.4 Sporadic and Non-Heritable Diseases

Not all the characterized human traits and diseases are attributed to mutant alleles at a single gene locus. Many diseases that have a heritable component, have more complex inheritance patterns due to (1) the involvement of multiple genes, and/or (2) environmental factors.

On the other hand, some non-genetic diseases may appear to be heritable because they affect multiple members of the same family, but this is due to the family members being exposed to the same toxins or other environmental factors (e.g., in their homes).

Finally, diseases with similar symptoms may have different causes, some of which may be genetic while others are not. One example of this is [Amyotrophic lateral sclerosis \(ALS\)](#); approximately 5–10% of cases are inherited in an AD pattern, while most of the remaining cases appear to be **sporadic**, in other words, not caused by a mutation inherited from a parent. We now know that different genes or proteins are affected in the inherited and sporadic forms of ALS. The physicist Stephen Hawking and baseball player Lou Gehrig both suffered from sporadic ALS.

Take a look at the following 2-Minute Neuroscience: Amyotrophic Lateral Sclerosis (ALS) video, by Neuroscientifically Challenged (2017), which describes how ALS arises in humans.

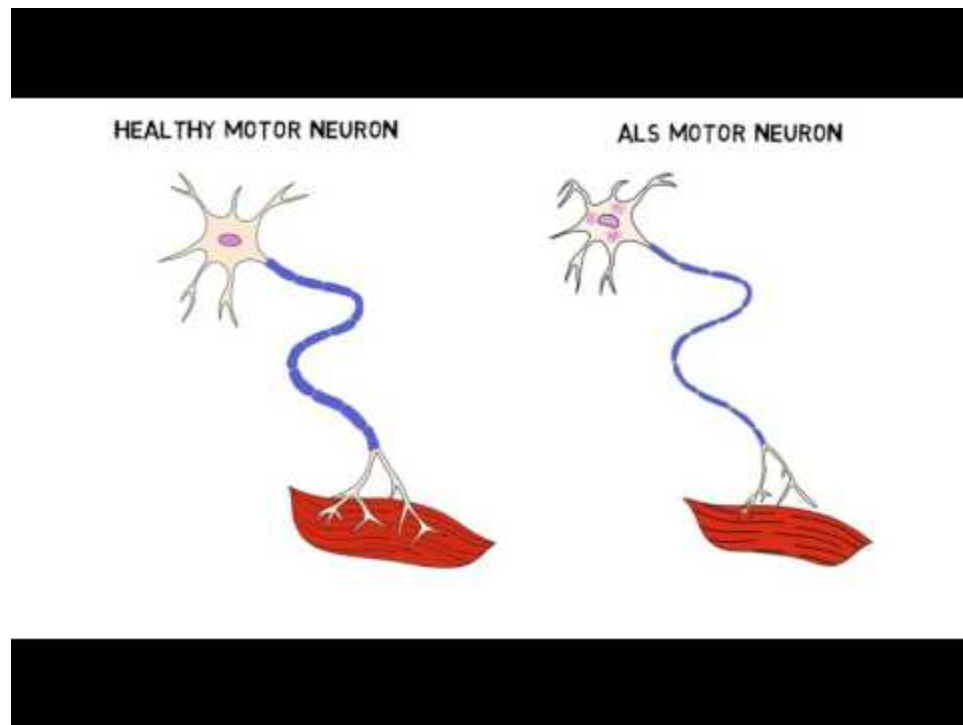

A YouTube element has been excluded from this version of the text. You can view it online here:

<https://opengenetics.pressbooks.tru.ca/?p=569>

Reference

Mayo Clinic Staff (n.d.). Amyotrophic lateral sclerosis (ALS). MayoClinic.org. <https://www.mayoclinic.org/diseases-conditions/amyotrophic-lateral-sclerosis/symptoms-causes/syc-20354022>

Neuroscientifically Challenged. (2017). 2-minute neuroscience: Amyotrophic lateral sclerosis (ALS) [Video file]. YouTube. <https://www.youtube.com/watch?v=kOnk9Hh20eg>

4.5 Calculating Probabilities Using Pedigree Charts

Once the mode of inheritance of a disease or trait is identified, some inferences about the genotype of individuals in a pedigree can be made, based on their phenotypes and where they appear in the family tree. Given these genotypes, it is possible to calculate the probability of a particular genotype being inherited in subsequent generations. This can be useful in genetic counselling, for example when prospective parents wish to know the likelihood of their offspring inheriting a disease for which they have a family history.

Probabilities in pedigrees are calculated using knowledge of Mendelian inheritance and the same basic methods as are used in other fields.

The first formula is the **product rule**: the joint probability of two independent events is the product of their individual probabilities; this is the probability of one event AND another event occurring.

For example:

The probability of a rolling a “five” with a single throw of a single six-sided die is $\frac{1}{6}$, and the probability of rolling “five” in each of three successive rolls is $\frac{1}{6} \times \frac{1}{6} \times \frac{1}{6} = \frac{1}{216}$.

The second useful formula is the **sum rule**, which states that the combined probability of two independent events is the sum of their individual probabilities. This is the probability of one event OR another event occurring.

For example:

The probability of rolling a five or six in a single throw of a dice is $\frac{1}{6} + \frac{1}{6} = \frac{1}{3}$.

With these rules in mind, we can calculate the probability that two carriers (i.e., heterozygotes) of an AR disease will have a child affected with the disease as $\frac{1}{2} \times \frac{1}{2} = \frac{1}{4}$, since for each parent, the probability of any gametes carrying the disease allele is $\frac{1}{2}$. This is consistent with what we already know from calculating probabilities using a Punnett square (e.g., in a monohybrid cross $Aa \times Aa$, $\frac{1}{4}$ of the offspring are aa).

We can likewise calculate probabilities in the more complex pedigree shown in **Figure 4.5.1**.

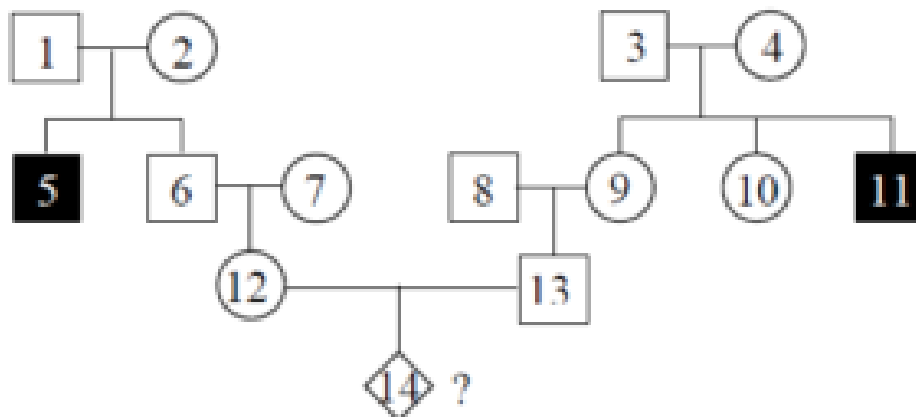

Figure 4.5.1 Individuals in this Pedigree are Labelled with Numbers to Make Discussion Easier [[Long description](#)]

Assuming the disease has an AR pattern of inheritance, what is the probability that individual #14 will be affected? We can assume that individuals #1, #2, #3 and #4 are heterozygotes (Aa), because they each had at least one affected (aa) child, but they are not affected themselves. This means that there is a $\frac{2}{3}$ chance that individual #6 is also Aa . This is because according to Mendelian inheritance, when two heterozygotes mate, there is a 1:2:1 distribution of genotypes $AA:Aa:aa$. However, because #6 is unaffected, he can't be aa , so he is either Aa or AA , but the probability of him being Aa is twice as likely as AA . By the same reasoning, there is likewise a $\frac{2}{3}$ chance that #9 is a heterozygous carrier of the disease allele.

If individual #6 is a heterozygous for the disease allele, then there is a $\frac{1}{2}$ chance that #12 will also be a heterozygote (i.e., if the mating of #6 and #7 is $Aa \times AA$, half of the progeny will be Aa ; we are also assuming that #7, who is unrelated, does not carry any disease alleles). Therefore, the combined probability that #12 is also a heterozygote is $\frac{2}{3} \times \frac{1}{2} = \frac{1}{3}$. This reasoning also applies to individual #13, i.e., there is a $\frac{1}{3}$ probability that he is a heterozygote for the disease. Thus, the overall probability that both individual #12 and #13 are heterozygous, and that a particular offspring of theirs will be homozygous for the disease alleles is $\frac{1}{3} \times \frac{1}{3} \times \frac{1}{4} = \frac{1}{36}$.

Media Attribution

- **Figure 4.5.1** [Original](#) attributed to Unknown (2017), [CC BY-NC 3.0](#), Open Genetics Lectures

Reference

Unknown. (2017). Figure 15. Individuals in this pedigree are labeled with...[digital image]. In Locke, J., Harrington, M., Canham, L. and Min Ku Kang (Eds.), *Open Genetics Lectures, Fall 2017* (Chapter 23, p. 7). Dataverse/ BCcampus. http://solr.bccampus.ca:8001/bcc/file/7a7b00f9-fb56-4c49-81a9-cfa3ad80e6d8/1/OpenGeneticsLectures_Fall2017.pdf

Long Description

- **Figure 4.5.1** Complex pedigree chart showing four generations. The purpose of this chart is simply to demonstrate that we are able to use the rules of probability to calculate the percentage chance of inheritance of a particular trait within a given family tree. The individuals in the chart are labelled from 1 to 14, throughout successive generations. All are shown to be unaffected, except for individual 5, who is part of Generation II and individual 11, also part of generation II. The text directly preceding this image describes in detail, how this chart can be interpreted using the rules of probability. [Back to [Figure 4.5.1](#)]

Chapter 4 Summary

The topics covered in this chapter can be summarized as follows:

- Pedigree analysis can be used to determine the mode of inheritance of specific traits such as diseases.
- Loci can be X- or Y-linked or autosomal in location and alleles either dominant or recessive with respect to wild type.
- If the mode of inheritance is known, a pedigree can be used to calculate the probability of inheritance of a particular genotype by an individual.

Take a look at the video below, *Pedigree Analysis*, by Nicole Lantz (2016) on YouTube, which summarizes the various pedigree patterns observed based on the different modes of inheritance.

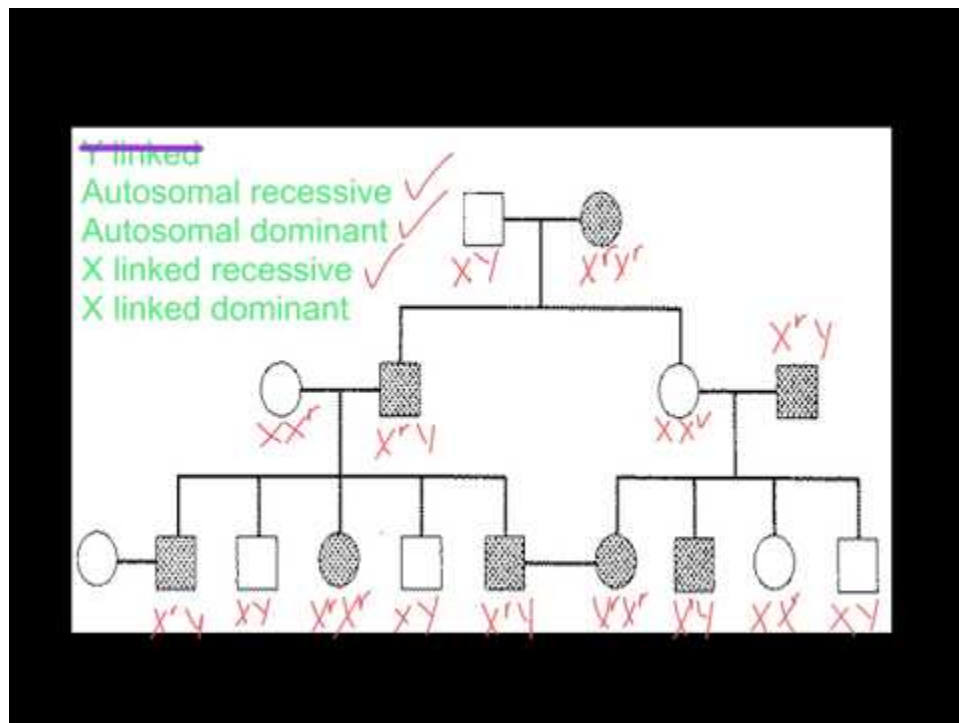

A YouTube element has been excluded from this version of the text. You can view it online here:

<https://opengenetics.pressbooks.tru.ca/?p=577>

Reference

Nicole Lance. (2016). Pedigree analysis [Video file]. YouTube. <https://www.youtube.com/watch?v=6VGcidNwQEo>

Key Terms in Chapter 4

Key Terms – Pedigree Analysis

- Achondroplasia
- affected
- autosomal dominant
- autosomal recessive
- carrier
- genetic counselling
- hairy-ear-rim
- Hemophilia A
- incomplete penetrance
- mode of inheritance
- Pedigree charts
- (PKU)
- proband
- product rule
- sporadic
- sum rule
- variable expressivity
- X-linked dominant
- X-linked recessive
- X-linked recessive
- Y-linked

Chapter 4 Study Questions

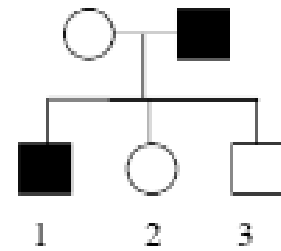

1. What are some of the modes of inheritance that are consistent with this pedigree?
2. In the pedigree in question 1, the mode of inheritance cannot be determined unambiguously. What are some examples of data (e.g., from other generations) that, if added to the pedigree, would help determine the mode of inheritance?
3. For each of the following pedigrees, name the most likely mode of inheritance (AR=autosomal recessive, AD=autosomal dominant, XR=X-linked recessive, XD=X-linked dominant). *These pedigrees were obtained from various external sources.

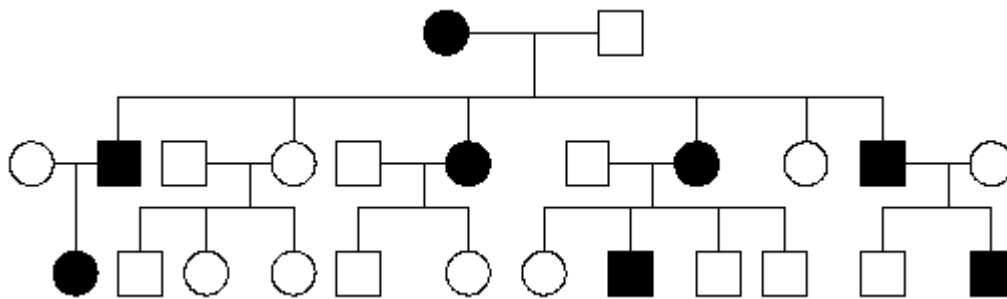

a.

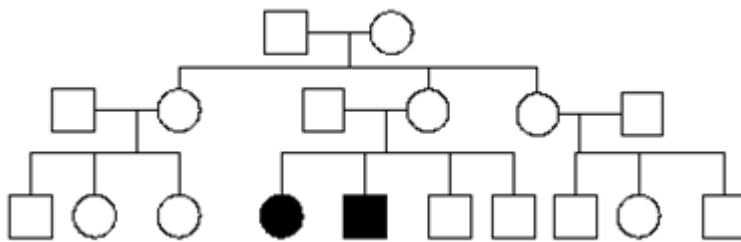

b.

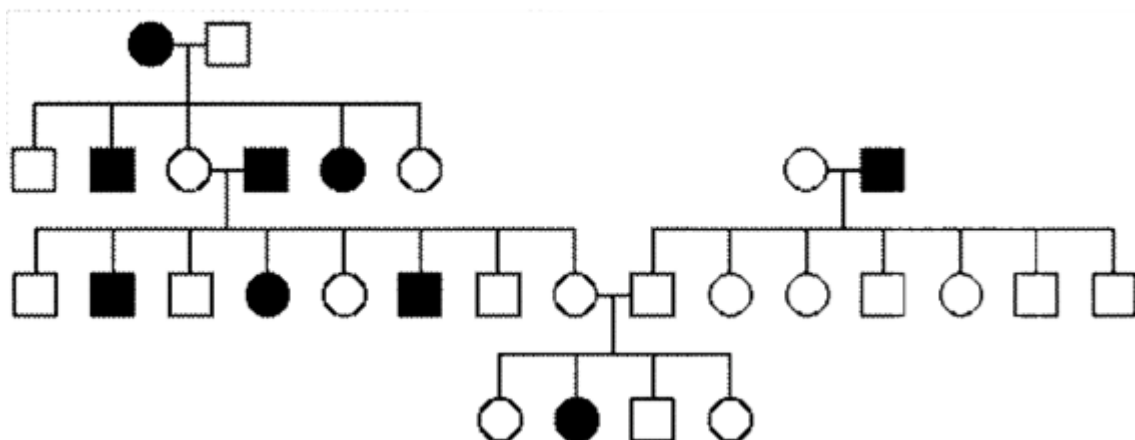

c.

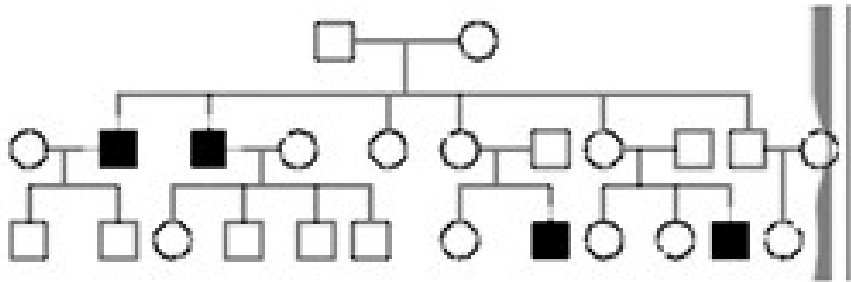

d.

4. The following pedigree represents a rare, autosomal recessive disease. What are the genotypes of the individuals

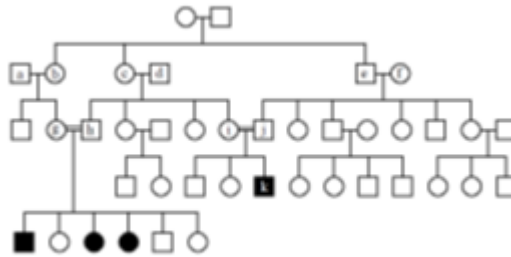

who are indicated by letters?

5. If individual #1 in the following pedigree is a heterozygote for a rare, AR disease, what is the probability that individual #7 will be affected by the disease? Assume that #2 and the spouses of #3 and #4 are not carriers.

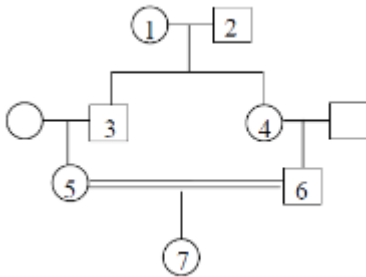

Chapter 4 Answers

1. The pedigree could show an AD, AR or XR mode of inheritance. It is most likely AD. It could be AR if the mother was a carrier, and the father was a homozygote. It could be XR if the mother was a carrier, and the father was a hemizygote. It cannot be XD, since the daughter (#2) would have necessarily inherited the disease allele on the X chromosome she received from her father.
2. There are many possible answers. Here are some possibilities: If neither of the parents of the father were affected (i.e., the paternal grandparents of children 1, 2, 3), then the disease could not be dominant. If only the paternal grandfather was affected, then the disease could only be X-linked recessive if the paternal grandmother was a heterozygote (which would be unlikely given that this is a rare disease allele).
3.
 - a. The mode of inheritance is most likely AD, since every affected individual has an affected parent, and the disease is inherited even in four different matings to unrelated, unaffected individuals. It is very unlikely that it is XD or XR, in part because affected father had an affected son.
 - b. The mode of inheritance cannot be AD or XD, because affected individuals must have an affected parent when a disease allele is dominant. Neither can it be XR, because there is an affected daughter of a normal father. Therefore, it must be AR, and this is consistent with the pedigree.
 - c. The mode of inheritance cannot be AD or XD, because, again, there are affected individuals with unaffected parents. It is not XR, because there are unaffected sons of an affected mother. It is therefore, likely, AR – but note that the recessive alleles for this condition appear to be relatively common in the population (note that two of the marriages were to unrelated, affected individuals).
 - d. The mode of inheritance cannot be AD or XD, because, again, there are affected individuals with unaffected parents. It could be either XR or AR, but because all the affected individuals are male, and no affected males pass the disease to their sons, it is likely XR.
4. If a represents the disease allele, individuals a, d, f (who all married into this unusual family) are AA , while b, c, e, g, h, i, j are all Aa , and k is aa .
5. There is a $\frac{1}{2}$ chance that an offspring of any mating $Aa \times AA$, will be a carrier (Aa). So, there is a $\frac{1}{2}$ chance that #3 will be Aa , and likewise for #4. If #3 is a carrier, there is again a $\frac{1}{2}$ chance that #5 will be a carrier, and likewise for #6. If #5 and #6 are both Aa , then there is a $\frac{1}{4}$ chance that this monohybrid cross will result in #7 having the genotype aa and, therefore, affected by the disease. Thus, the joint probability is $\frac{1}{2} \times \frac{1}{2} \times \frac{1}{2} \times \frac{1}{2} \times \frac{1}{4} = \frac{1}{64}$.

CHAPTER 5 - THE COMPLEMENTATION TEST

5.1 Introduction

Learning Objectives

- Recall that mutant screening is one of the first steps geneticists use to investigate biological processes.
- Distinguish between allelic and non-allelic mutations.
- Describe the use of the Complementation Test (otherwise known as cis-trans test) and identify complementation groups.

A particular phenotype is usually the result of the biochemical product(s) of multiple genes acting in a pathway. Polygenic inheritance occurs when one characteristic is controlled by two or more genes. Often, the genes are large in quantity but small in effect. Examples of human polygenic inheritance are height, skin colour, eye colour, and weight. A mutation in any one given gene of the set governing a phenotype, can result in an alteration of the manifested trait. How then do geneticists determine if two mutants which have the same phenotype carry their mutation in the same gene or in different genes? We achieve this by the use of the **Complementation Test**.

A complementation test consists of classical Mendelian genetic crosses to determine if one mutant can complement another or, in other words, produce the wild type phenotype. More recently, transformation of DNA with a gene has been used to determine if inserting a single gene into a cell/organism can rescue a mutant phenotype.

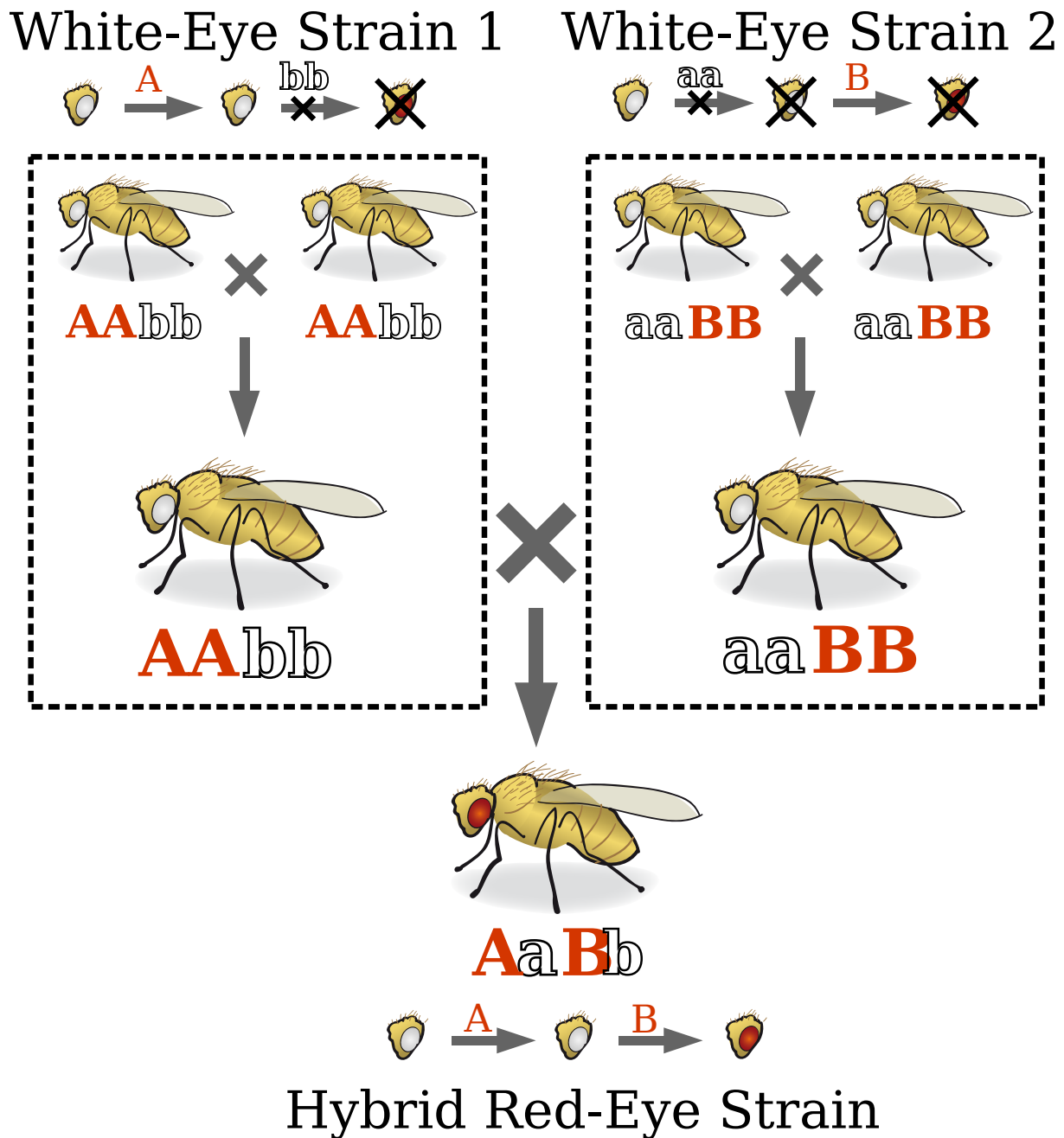

Figure 5.1.1 Example of Genetic Complementation. Two strains of flies are white eyed because of two different autosomal recessive mutations which interrupt a single pigment-producing metabolic pathway at two different points. Flies from Strain 1 have complementary mutations to flies from Strain 2 because when they are crossed, the offspring are able to complete the full metabolic pathway and, thus, have red eyes. A fly from Strain 1 is not complementary to another fly from Strain 1 because they are both homozygous for mutations affecting the same point in the pathway, so their offspring will be white-eyed.

Media Attribution

- **Figure 5.1.1** [Complementation](#) by Mcstrother, [CC BY-SA 3.0](#), via Wikimedia Commons

5.2 Complementation Tests and Allelism

Mutant screening is one of the starting points geneticists use to investigate biological processes. Geneticists can observe two independently derived mutants with similar phenotypes, through a mutant screen or in natural populations. An immediate question from this observation is whether or not the mutant phenotype is due to a loss of function in the same gene, or are they mutant in different genes that both cause the same phenotype (e.g., in the same pathway). In other words, are they **allelic mutations** or **non-allelic mutations**, respectively? This question can be resolved using **complementation tests**, which bring together or combine, the two mutations under consideration into the same organism to assess the combined phenotype.

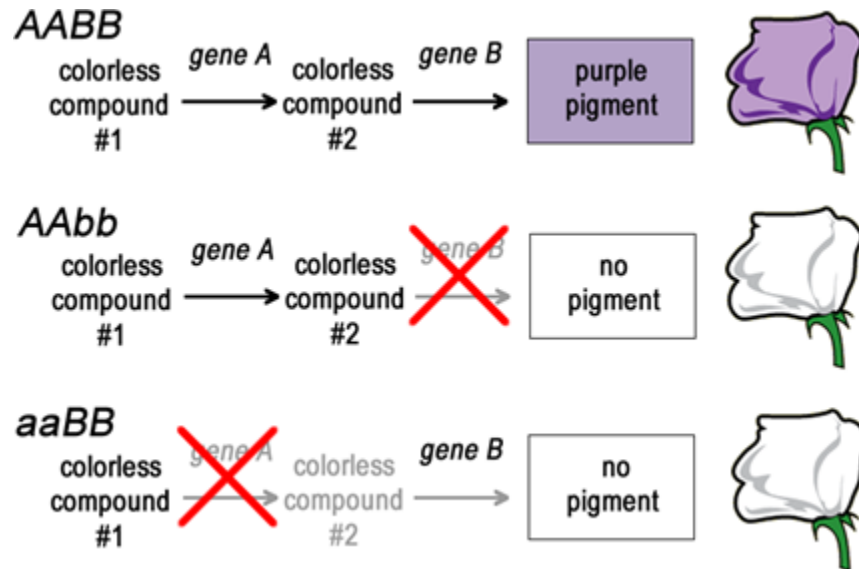

Figure 5.2.1 In This Simplified Biochemical Pathway, Two Enzymes Encoded by Two Different Genes Modify Chemical Compounds in Two Sequential Reactions to Produce a Purple Pigment. Loss of either of the enzymes disrupts the pathway and no pigment is produced. [[Long description](#)]

The easiest way to understand a complementation test is by example (**Figure 5.2.1**). The pigment in a purple flower could depend on a biochemical pathway much like the **biochemical pathways** leading to the production of arginine in *Neurospora* ([Chapter 7](#)). A diploid plant that lacks the function of gene A (genotype *aa*) would produce mutant white flowers that phenotypically looked just like the white flowers of a plant that lacked the function of gene B (genotype *bb*). Both A and B are enzymes in the same pathway that leads from a colourless compound #1, through colourless compound #2, to the purple pigment. Blocks at either step will result in a mutant white flower instead of the wild type purple flower.

Strains with mutations in gene A can be represented as the genotype *aa*, while strains with mutations in gene B can be represented as *bb*. Given that there are two genes here, A and B, then each of these mutant strains can be more completely represented as *aaBB* and *AAbb*. (LEARNING NOTE: Students often forget that genotypes usually only show mutant loci, however, one must remember all the other genes in the diploid genome are assumed to be wild type.)

If these two strains are crossed together the resulting progeny will all be *AaBb*. They will have both a wild type, functional A gene and B gene and will thus have a pigmented, purple flower, a wild type phenotype. This is an example of

complementation. Together, each strain provides what the other is lacking ($AaBb$). The mutations are in different genes and are thus called **non-allelic mutations**.

Now, if we are presented with a third pure-breeding, independently derived, white-flower, mutant strain, we won't initially know if it is mutant in gene A, gene B, or some other gene altogether. We can use complementation testing to determine which gene is mutated. To perform a complementation test, two homozygous individuals with similar mutant phenotypes are crossed (**Figures 5.2.2 & 5.2.3**).

If the F_1 progeny all have the same mutant phenotype (Case 1 – **Figure 5.2.2**), then we infer that the same gene is mutated in each parent. These mutations would then be called **allelic mutations** – mutant in the same gene locus. These two mutations FAIL to COMPLEMENT one another (still mutant). These could either be exactly the same mutant alleles (same base pair changes), or different mutations (different base pair changes, but in the same gene – allelic).

Conversely, if the F_1 progeny all appear to be wild type (Case 2 – **Figure 5.2.3**), then each of the parents most likely carries a mutation in a different gene. These mutations would then be called **non-allelic mutations** – mutant in a different gene locus. These mutations DO COMPLEMENT one another.

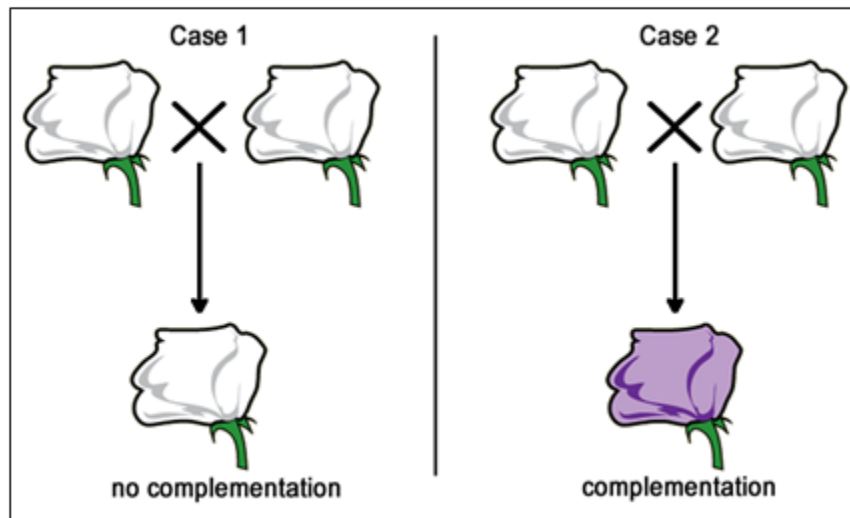

Figure 5.2.2 Observation: In a Typical Complementation Test, the Genotypes of Two Parents Are Unknown. (Although, they must be pure breeding, homozygous mutants.) If the F_1 progeny all have a mutant phenotype (Case 1), there is no complementation. If the F_1 progeny are all wild-type, the mutations have successfully complemented each other. [\[Long description\]](#)

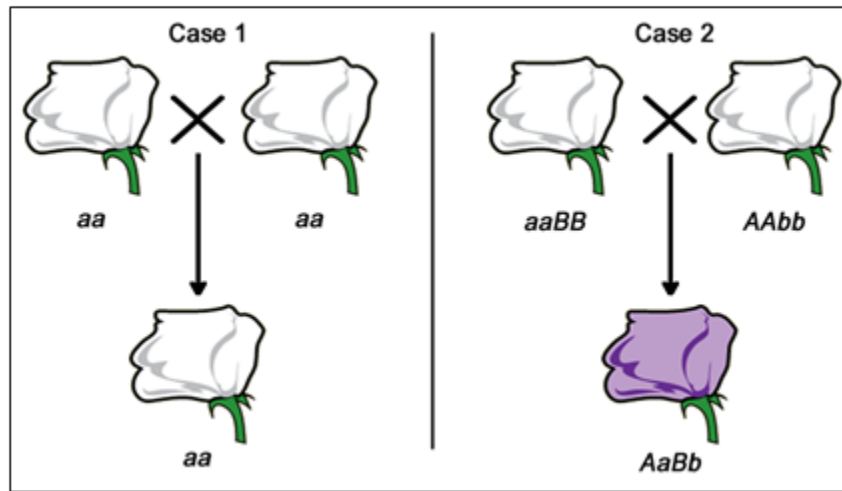
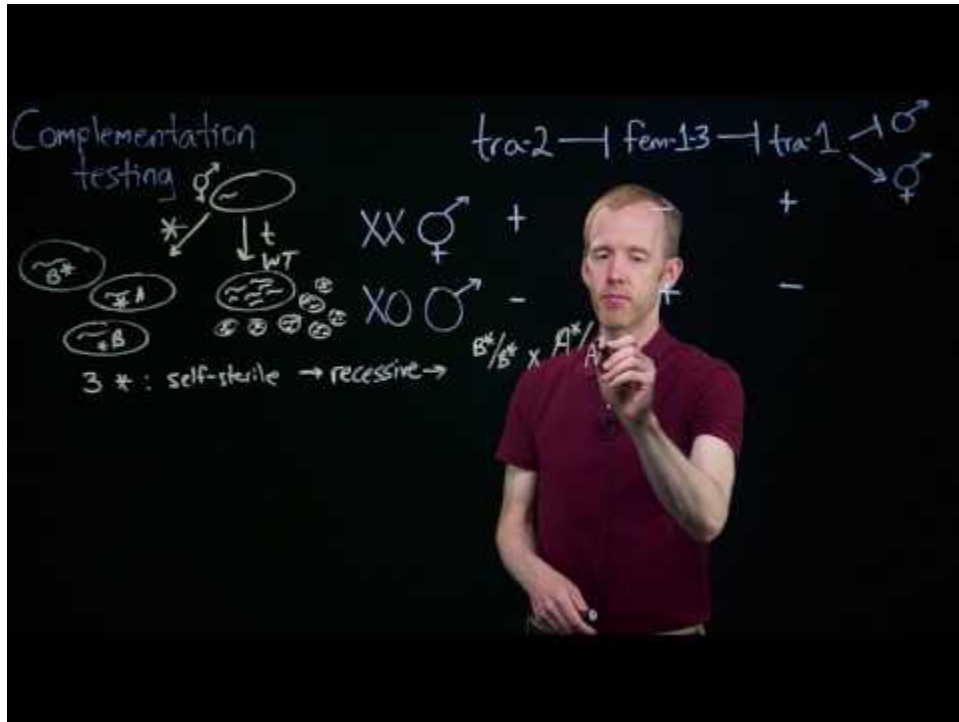

Figure 5.2.3 Interpretation: The Pure Breeding, Homozygous Mutant Parents had Unknown Genotypes Before the Complementation Test. It could be assumed that they had either mutations in the same genes (Case 1) or in different genes (Case 2). In Case 1, all of the progeny would have the mutant phenotype, because they would all have the same, homozygous genotype as the parents. In Case 2, each parent has a mutation in a different gene, therefore none of the F1 progeny would be homozygous mutant at either locus. Note that the genotype in Case 1 could be written as either *aa* or *aaBB*. [[Long description](#)]

Note: For mutations to be used in complementation tests they are (1) usually true-breeding (homozygous at the mutant locus), and (2) must be recessive mutations. Dominant and semi-dominant mutations CANNOT be used in complementation tests, since these mutations won't show complementation effects of two non-allelic genes. (3) Note that haploid organisms like *Neurospora* cannot be used in complementation test since they have only one set of chromosome (4). Also, remember, some mutant strains may have more than one gene locus mutated and thus would fail to complement mutants from more than one other locus (or group).

Take a look at the following video, *Complementation Testing*, by Joseph Ross (2017), which explains how to perform and interpret complementation tests.



A YouTube element has been excluded from this version of the text. You can view it online here:

<https://opengenetics.pressbooks.tru.ca/?p=609>

Media Attributions

- **Figure 5.2.1** [Original](#) by Deyholos (2017), [CC BY-NC 3.0](#), Open Genetics Lectures
- **Figure 5.2.2** [Original](#) by Deyholos (2017), [CC BY-NC 3.0](#), Open Genetics Lectures
- **Figure 5.2.3** [Original](#) by Deyholos (2017), [CC BY-NC 3.0](#), Open Genetics Lectures

References

- Deyholos, M. (2017). Figures: 2. Simplified biochemical pathway, 3A. Observation, and 3B. Interpretation [diagrams]. In Locke, J., Harrington, M., Canham, L. and Min Ku Kang (Eds.), *Open Genetics Lectures, Fall 2017* (Chapter 4, p. 1-2). Dataverse/ BCcampus. http://solr.bccampus.ca:8001/bcc/file/7a7b00f9-fb56-4c49-81a9-cfa3ad80e6d8/1/OpenGeneticsLectures_Fall2017.pdf
- Joseph Ross. (2017, July 10). Complementation testing (video file). YouTube. <https://www.youtube.com/watch?v=knjxwahC6tY>

Long Descriptions

- **Figure 5.2.1** Three potential biochemical pathways in the production of flower colour in a particular organism, whereby this trait is governed by two different genes. In the first option, both genes (A and B) are active, thereby allowing the conversion of colourless compound 1 into colourless compound 2, and then conversion of colourless compound 2 into purple pigment, producing purple flowers. In the second option, gene B is inactive, and so no pigment results in white flowers. Similarly, in option 3, gene A is inactive, resulting in no pigment, and therefore white flowers are produced. [Back to [Figure 5.2.1](#)]
- **Figure 5.2.2** The observations possible when conducting complementation tests. In the first case, two white flowers are mated to produce white flowered offspring, which indicates no complementation is occurring. In the second case, two white-flowered plants are mated to produce offspring with purple flowers, indicating that complementation is occurring in this case. [Back to [Figure 5.2.2](#)]
- **Figure 5.2.3** Replica of Figure 5.2.2, except in this case, the potential genotypes of the organisms in the crosses of case 1 and case 2 are outlined. In case 1, both parents are aa, with offspring also being aa. In case 2, one parent is aaBB while the other is Aabb, giving rise to offspring AaBb. In case 1, all progeny would have the mutant phenotype, because they would all have the same, homozygous genotype as the parents. In Case 2, each parent has a mutation in a different gene, therefore none of the F1 progeny would be homozygous mutant at either locus. [Back to [Figure 5.2.3](#)]

5.3 Complementation Groups = Groups of Allelic Mutations

So, with the third mutant strain above, we could assign it to be allelic with either gene A or gene B, or some other locus, should it complement both gene A and gene B mutations. If they came from different natural populations or from independently mutagenized individuals, we could have a fourth, fifth, sixth, etc. white flower strain, then we could begin to organize the allelic mutations into groups, which are called **complementation groups**. These are groups of mutations that FAIL TO COMPLEMENT one another (a group of NON-complementing mutations) and are assumed to have mutations in the SAME gene; hence they are grouped as complementation group. A group can consist of as few as one mutation and as many as all the mutants under study. Each group represents a set of mutations in the same gene (allelic). The number of complementation groups represents the number of genes that are represented in the total collection of mutations.

It all depends on how many mutations you have in a gene. For example, the *white* gene in *Drosophila* has >300 different mutations within the *white* gene described in the literature. If you were to obtain and cross all these mutations to themselves, you would find they all belonged to the same complementation group or same *white* gene. Each complementation group represents a gene.

If, however, you obtained a different mutation, *vestigial* for example, which affects wing growth, and crossed it to a *white* eye-colour mutation, the double heterozygote would result in red eyes and normal wings (wild type for both characters) so the two would complement and represent two different complementation groups: (1) *white*, (2) *vestigial*. The same would be true for the other eye-colour mutations mentioned elsewhere in this text. For example, if you crossed a *scarlet* eye-colour mutant to a *white* eye-colour mutant, the double heterozygote would have wild type red eyes. Each mutant has the wild type allele of the other. Again, remember that all the other genes in the diploid genome are assumed to be wild type.

To drive home the concept of complementation groups, we will look at two hypothetical examples.

Example 1: Multiple Mutant Complementation Test

The first example (**Figure 5.3.1**) shows the results of a series of crosses as a complementation test table with six mutants labelled a to f. The mutants fall into three complementation groups in total: (1) a (2) b, c, f, and (3) d, e. Notice that a complementation group can consist of only one mutant, or more than one.

#	a	b	c	d	e	f
a	w					
b	p	w				
c	p	w	w			
d	p	p	p	w		
e	p	p	p	w	w	
f	p	w	w	p	p	w

Figure 5.3.1 Complementation Test Table Showing Which Flower Mutant Strains Complement Each Other and Vice Versa. “w” stands for the white flowers, which is mutant (no complementation) and “p” stands for purple which represents wild type (complementation). Blanks are for crosses not completed. [\[Long description\]](#)

Example 2: Double Hit Strain

The second example (**Figure 5.3.2**) is similar, but has a twist. It has five mutants labelled 1-5, with 1-4 being mutations in only a single gene each, while mutant #5 has mutations in two different genes, and thus is unable to complement the mutations in two, different genes. A **double-hit strain** like strain #5 is normally a very rare event, but is included here to make a point. A double-hit strain may appear to belong in two different groups. In this case, mutants #3 and #4 complement (different genes) but #5 fails to complement both #3 and #4, indicating it has mutations in both the mutant genes in #3 (gene B) and #4 (gene C) (**Figure 5.3.3**).

	1	2	3	4	5
1	-				
2	-	-			
3	+	+	-		
4	+	+	+	-	
5	+	+	-	-	-

Figure 5.3.2 Complementation Test Table with Pink as Mutant and Green as Wild Type. (Black is for crosses not completed.) Note: mutant #5 has two mutations. [\[Long description\]](#)

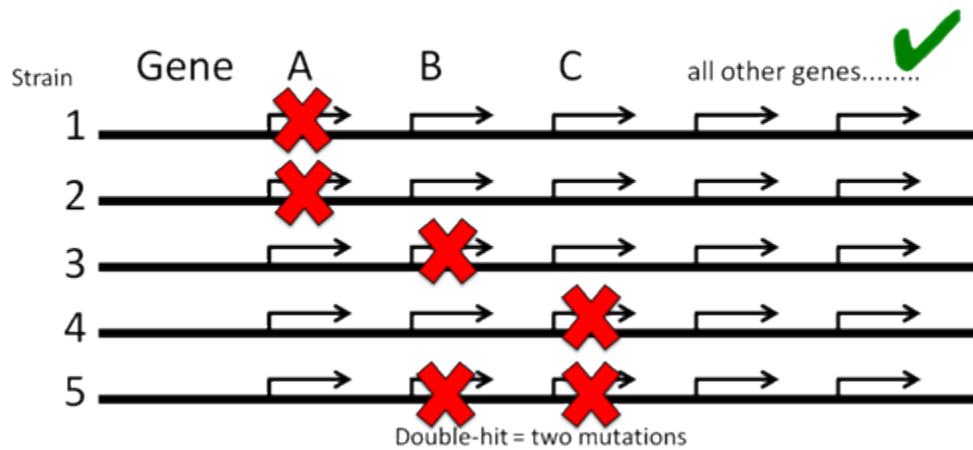

Figure 5.3.3 Chromosomes of the Organisms Used in Complementation Tests to Decide if Genes are Allelic or Non-Allelic. [\[Long description\]](#)

Media Attributions

- **Figure 5.3.1 Original** by Di Cara (2017), [CC BY-NC 3.0](#), Open Genetics Lectures
- **Figure 5.3.2 Original** by Locke (2017), [CC BY-NC 3.0](#), Open Genetics Lectures
- **Figure 5.3.3 Original** by Locke (2017), [CC BY-NC 3.0](#), Open Genetics Lectures

References

- Di Cara. (2017). Figure 4. Complementation test table [diagrams]. In Locke, J., Harrington, M., Canham, L. and Min Ku Kang (Eds.), *Open Genetics Lectures, Fall 2017* (Chapter 4, p. 3). Dataverse/ BCcampus. http://solr.bccampus.ca:8001/bcc/file/7a7b00f9-fb56-4c49-81a9-cfa3ad80e6d8/1/OpenGeneticsLectures_Fall2017.pdf
- Locke, J. (2017). Figures: 5. Complementation test table with pink as mutant, and 6. Chromosomes of the organisms that are used...[diagrams]. In Locke, J., Harrington, M., Canham, L. and Min Ku Kang (Eds.), *Open Genetics Lectures, Fall 2017* (Chapter 4, p. 4). Dataverse/ BCcampus. http://solr.bccampus.ca:8001/bcc/file/7a7b00f9-fb56-4c49-81a9-cfa3ad80e6d8/1/OpenGeneticsLectures_Fall2017.pdf

Long Descriptions

- **Figure 5.3.1** A grid shows the crosses conducted when carrying out complementation testing, and how results are depicted. In this case, the top row and left-hand column outline the various mutants, listed from a to f. In the resulting boxes upon mating, offspring are indicated as “w” which stands for the white flowers, which is mutant (no complementation) and “p”, which stands for purple, which represents wild type (complementation). Boxes are left blank if no crosses are done for that pair of mutants. [Back to [Figure 5.3.1](#)]
- **Figure 5.3.2** Similar to Figure 5.3.1, except the mutants are listed in the top row and left-hand column from 1 to 5, and the results of the crosses between each pair of mutants indicated by a plus sign (+) to indicate complementation is occurring, or a negative sign (-) to indicate no complementation is taking place. Boxes shaded back indicate those two mutants were not crossed. [Back to [Figure 5.3.2](#)]
- **Figure 5.3.3** Five solid back lines represent strains (1 to 5), each containing a number of genes, A, B, C etc. In strain 1, gene A is not active, represented by a red cross over that gene. The same is shown for strain 2. In strain 3, gene B is inactive, and in strain 4, gene C is inactive. Finally, in strain 5, genes B and C are inactive. This image represents how different organisms can be used in complementation tests to determine if genes are allelic or non-allelic. [Back to [Figure 5.3.3](#)]

5.4 Transformation Rescue

Beadle and Tatum built on this connection between genes and **metabolic pathways**. Their research led to the “**one gene, one enzyme (or protein)**” hypothesis, which states that each enzyme that acts in a biochemical pathway is encoded by a different gene. Although we now know of many exceptions to the “one gene, one enzyme” principle, it is generally true that each different gene produces a protein with a distinct catalytic, regulatory, or structural function.

Beadle and Tatum used the fungus *Neurospora crassa* (a bread mould) for their studies, because it had practical advantages as a laboratory model organism. They knew that *Neurospora* was **prototrophic**, meaning it could grow on **minimal medium (MM)**. Minimal medium lacked most nutrients, except for a few minerals, simple sugars, and one vitamin (biotin).

Prototrophs can synthesize the amino acids, vitamins, etc., necessary for normal growth.

They also knew that by exposing *Neurospora* spores to X-rays, they could randomly induce mutations in genes (now known as damage to the DNA leading to DNA sequence change). Each spore exposed to X-rays potentially contained a mutation in a different gene. While most mutagenized spores were still able to grow (prototrophic), some spores had mutations that changed their phenotype from a prototroph into an **auxotrophic** strain, which could no longer grow on minimal medium. Instead, these auxotrophs could grow on **complete medium (CM)**, which was MM supplemented with nutrients, such as amino acids and vitamins, etc. (**Figure 5.4.1**). In fact, some auxotrophic mutations could grow on minimal medium with only one single nutrient supplied, such as the amino acid arginine. This implied that each auxotrophic mutant was blocked at a specific step in a biochemical pathway, and that by adding an essential compound, such as arginine, that block could be circumvented.

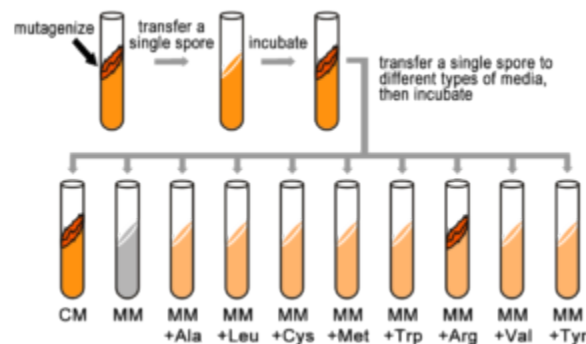

Figure 5.4.1 A Single Mutagenized Spore is Used to Establish a Colony of Genetically Identical Fungi, From Which Spores are Tested for Their Ability to Grow on Different Types of Media. Because spores of this particular colony can grow only on complete medium (CM), or on minimal medium supplemented with arginine (MM+Arg), they are considered Arg auxotrophs, and we infer that they have a mutation in a gene in the Arg biosynthetic pathway. This type of screen is repeated many times to identify other mutants in the Arg pathway and in other pathways. [[Long description](#)]

Beadle and Tatum’s experiments are important not only for their conceptual advances in understanding genes, but also because they demonstrate the utility of **screening for genetic mutants** to investigate a biological process – **genetic analysis**. Beadle and Tatum’s results were useful to investigate biological processes, specifically the metabolic pathways that produce amino acids. For example, Srb and Horowitz, in 1944, tested the ability of the amino acids to

rescue auxotrophic strains. They added one of each of the amino acids to minimal medium and recorded which of these restored growth to independent mutants.

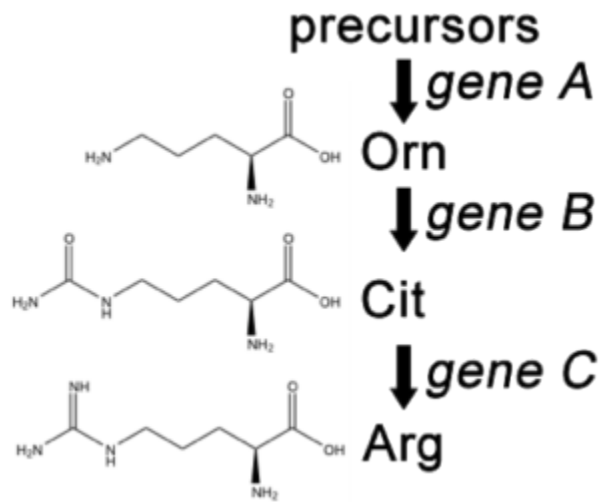

Figure 5.4.2 A Simplified Version of the Arg Biosynthetic Pathway, Showing Citrulline (Cit) and Ornithine (Orn) as Intermediates in Arg Metabolism. These chemical reactions depend on enzymes represented here as the products of three different genes. [[Long description](#)]

A convenient example is arginine. If the progeny of a mutagenized spore could grow on minimal medium only when it was supplemented with **arginine (Arg)**, then the auxotroph must bear a mutation in the Arg biosynthetic pathway and was called an “arginineless” strain (arg⁻). Synthesis of even a relatively simple molecule, such as arginine, requires many steps, each with a different enzyme. Each enzyme works sequentially on a different intermediate in the pathway (**Figure 5.4.2**). For arginine (Arg), two biochemical intermediates are ornithine (Orn) and citrulline (Cit). Thus, mutation of any one of the enzymes in this pathway could turn *Neurospora* into an Arg auxotroph (arg⁻). Srb and Horowitz extended their analysis of Arg auxotrophs by testing the intermediates of amino acid biosynthesis for the ability to restore growth of the mutants (**Figure 5.4.3**).

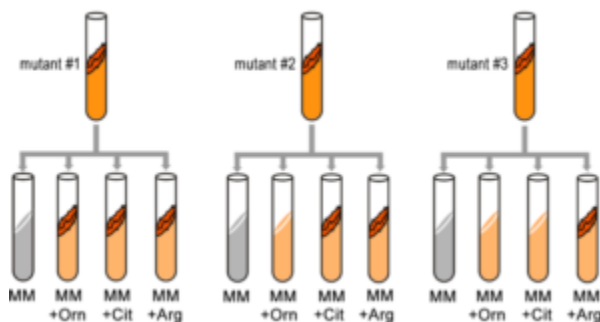

Figure 5.4.3 Testing Different Arg Auxotrophs for Their Ability to Grow on Media Supplemented with Intermediates in the Arg Biosynthetic Pathway [[Long description](#)]

They found that only Arg could rescue all the Arg auxotrophs, while either Arg or Cit could rescue some (**Table 5.4.1**).

Based on these results, they deduced the location of each mutation in the Arg biochemical pathway, (i.e., which gene was responsible for the metabolism of which intermediate).

Table 5.4.1 Ability of Auxotrophic Mutants of Each of the Three Enzymes of the Arg Biosynthetic Pathways to Grow on Minimal Medium (MM) Supplemented with Arg or Either of its Precursors, Orn and Cit. Gene names refer to the labels used in Figure 1.3.3 Meiosis in Arabidopsis

Mutants in:	MM + Orn	MM + Cit	MM + Arg
Gene A	Yes	Yes	Yes
Gene B	No	Yes	Yes
Gene C	No	No	Yes

In a normal rescue experiment, arginine auxotrophic strands of single-celled *Neurospora crassa* were “rescued” when supplemented with the amino acids that they could not synthesize and that were essential for the organism’s metabolism. In transformation rescue, rather than giving supplementary metabolic pathway products, it supplies the needed genes that can complement the mutant allele. The process of taking in foreign DNA (**transformation**) that contains the normal version of the gene and thereby **rescuing** the auxotrophic strain is called **transformation rescue**.

Let’s say that there is an *E. coli* auxotrophic mutant in a gene called “a” (**Table 5.4.2**).

Table 5.4.2 The Auxotrophic Strain (a-) Cannot Grow on MM (Minimal Medium) but the Prototrophic Strain (a+) Can Grow.

E. coli Strain	MM (Minimal medium)	MM + supplement
a-	Auxotrophic (no growth)	Growth
a+	Growth	Growth

In order to transform this auxotrophic strain and rescue, we need to:

1. Make the *E. coli* auxotrophic cells competent so that it can incorporate foreign DNA molecules. We can form a competent cell via **heat shock** or **electroporation** that can slightly damage the membrane and therefore provide passageways for DNA molecules to enter the cell.
2. Extract DNA molecules from a wild type strain of *E. coli* and break them down into short fragments using enzymes.
3. Insert these short fragments of *E. coli* DNA into a **DNA vector**, which is a DNA molecule that can contain, amplify, and transfer the inserted DNA fragments into the host cell. This combined DNA molecule is called **recombinant DNA**. **Plasmids** are small circular DNA molecules that are mostly found in bacteria and are suitable as DNA vectors. The [vector + DNA insert] molecule can be replicated, and the result would be multiple **clones** of the original DNA insert.
4. After the *E. coli* DNA fragments (that were once a single long DNA molecule) are inserted into DNA vectors, we have a collection of recombinant DNA molecules, which when transformed, can be called a **DNA library**. Among all the recombinant DNA molecules in the library, there are three possibilities (**Figure 5.4.1**): (1) DNA clones that contain gene *a*, (2) DNA clones that don’t contain gene *a*, which will be collectively presented by the letter *b* and (3) DNA clones that don’t contain any foreign genes.
5. Combine the recombinant DNA molecules and host *E. coli* strain together, so that the auxotrophic strain can incorporate those DNA molecules through transformation. Growing the strains on minimal and complete media will let us decide if the transformation rescue worked or not.
6. The host strain’s genotype is a-b+. It needs a wild type a+ to grow on minimal medium. Therefore, plasmids that

have the a^+ allele would grow (prototrophic), and other strains that have either a plasmid with no transgene or have a plasmid with gene b^+ would be still auxotrophic.

Notice that the plasmids contain an antibiotic resistance gene called **AntiR** and that the strains were grown on minimal medium that contained antibiotics. Why was this so? This is because we want to select for the ones that incorporated the plasmid that contained the wild-type “a” gene.

Only a small fraction of cells is transformed by foreign DNA. Therefore, if we grow those strains on agar plate without antibiotics, we cannot guarantee the growth was due to the complementation between the host DNA and the recombinant DNA or by some reversion back to wild type. There is a small possibility that the cells that weren't transformed could somehow synthesize the essential substrate due to a spontaneous mutation. Adding the antibiotic selection will remove cells that weren't transformed and, therefore, don't contain a plasmid with the antibiotic resistance gene, and select for the cells that were successfully transformed and complemented by the recombinant DNA.

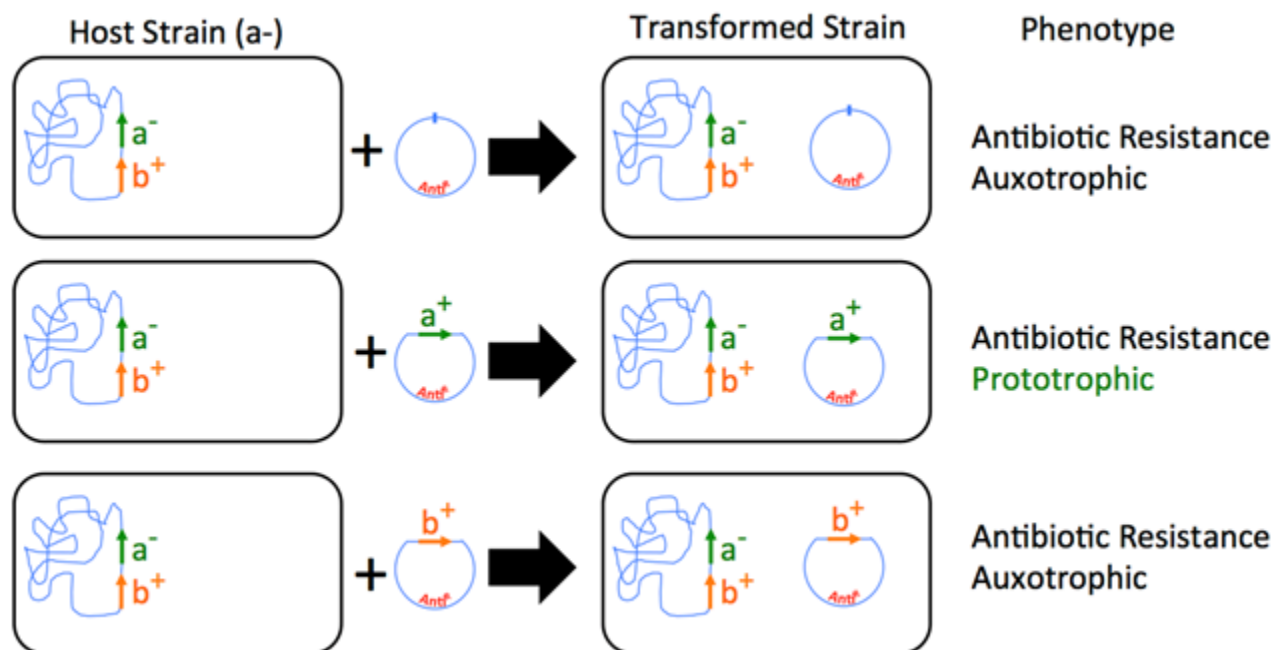

Figure 5.4.4 Transformation Rescue Diagram [Long description]

Media Attributions

- **Figure 5.4.1** [Original](#) by Deyholos (2017), [CC BY-NC 3.0](#), Open Genetics Lectures
- **Figure 5.4.2** [Original](#) by Deyholos (2017), [CC BY-NC 3.0](#), Open Genetics Lectures
- **Figure 5.4.3** [Original](#) by Deyholos (2017), [CC BY-NC 3.0](#), Open Genetics Lectures
- **Figure 5.4.4** [Original](#) by Locke (2017), [CC BY-NC 3.0](#), Open Genetics Lectures

References

Deyholos, M. (2017). Figures: 3. A single mutagenized spore; 4. A simplified version of the Arg biosynthetic pathway...;

and 5. Testing different Arg auxotrophs... [image]. In Locke, J., Harrington, M., Canham, L. and Min Ku Kang (Eds.), *Open Genetics Lectures, Fall 2017* (Chapter 3, p. 3). Dataverse/ BCcampus. http://solr.bccampus.ca:8001/bcc/file/7a7b00f9-fb56-4c49-81a9-cfa3ad80e6d8/1/OpenGeneticsLectures_Fall2017.pdf

Locke, J. (2017). Figure 7. Transformation rescue diagram [digital image]. In Locke, J., Harrington, M., Canham, L. and Min Ku Kang (Eds.), *Open Genetics Lectures, Fall 2017* (Chapter 4, p. 5). Dataverse/ BCcampus. http://solr.bccampus.ca:8001/bcc/file/7a7b00f9-fb56-4c49-81a9-cfa3ad80e6d8/1/OpenGeneticsLectures_Fall2017.pdf

Long Descriptions

- **Figure 5.4.1** Production of a colony of genetically identical fungi. First, in a test tube, the sample is mutagenized, and then a single spore is transferred to another test tube, which is then incubated. Then, we transfer a single spore to different types of media, and incubate. Spores are Tested for Their Ability to Grow on Different Types of Media. Because spores of this particular colony are able to grow only on complete medium (CM), or on minimal medium supplemented with arginine (MM+Arg), they are considered Arg auxotrophs and we infer that they have a mutation in a gene in the Arg biosynthetic pathway. This type of screen is repeated many times to identify other mutants in the Arg pathway and in other pathways. [Back to [Figure 5.4.1](#)]
- **Figure 5.4.2** Three organic structures – ornithine, citrulline and Arginine. From a precursor, Gene A is able to facilitate synthesis of ornithine. Gene B then converts it into Citrulline. Finally, gene C converts this into Arginine. This biosynthetic pathway shows the involvement of multiple genes in the synthesis of nutrients within a cell. [Back to [Figure 5.4.2](#)]
- **Figure 5.4.3** Three test tubes labelled mutant 1, 2 and 3 respectively. In each case, the mutants are subjected to four different types of media – that is, each is supplemented with a different combination of nutrients. The media are minimal media (MM), MM + ornithine, MM + citrulline and MM + arginine. The ability (or not) of the mutants to proliferate within the various media is indicative of their genotypes. [Back to [Figure 5.4.3](#)]
- **Figure 5.4.4** The differences between auxotrophic and prototrophic organisms. A plasmid carrying an a⁺ gene is used to rescue an a⁻ strain. The product of the a⁺ strain is an enzyme, which then confers antibiotic resistance. Adding the antibiotic selection will remove cells that weren't transformed and, therefore, don't contain a plasmid with the antibiotic resistance gene, and select for the cells that were successfully transformed and complemented by the recombinant DNA. [Back to [Figure 5.4.4](#)]

Chapter 5 Summary

The topics covered in this chapter can be summarized as follows:

- The purpose of performing Complementation testing is to determine whether two mutants are the result of mutation of the same gene (allelic mutations), or if each mutant is caused by mutation of a different gene (non-allelic mutations).
- Complementation group contains mutants that cannot complement each other (allelic mutations) and therefore are assumed to have mutations at the same gene loci.
- Transformation rescue refers to the incorporation of recombinant DNA molecule that contains a gene that is able to complement the mutated gene in another organism.

Key Terms in Chapter 5

Key Terms – The Complementation Test

- allelic mutations
- biochemical pathways
- clones
- complementation group
- complementation test
- complementation
- DNA library
- DNA vector
- double-hit strain
- heat shock
- non-allelic mutations
- Plasmids
- Recombinant DNA
- rescue
- transformation rescue
- transformation

Chapter 5 Study Questions

1. You are working with a prototrophic model organism (e.g., a fungus). You are interested in finding genes involved in synthesis of proline (Pro), an amino acid that is normally synthesized by this organism.
 - a. How would you design a mutant screen to identify genes required for Pro synthesis?
 - b. Imagine that your screen identified ten mutants (labelled #1 through #10) that grew very poorly unless supplemented with Proline. How could you determine the number of different genes represented by these mutants?
 - c. If each of the ten mutants represents a different gene, what will be the phenotype of the F₁ progeny if any pair of the ten mutants are crossed?
 - d. If all ten mutants represent the same gene, what will be the phenotype of the F₁ progeny if any pair of the ten mutants are crossed?
2. Draw the expected results of a series of complementation tests (crosses), in the form of a table, for five yeast mutant strains where there are at least three different mutant loci, and one of the mutations involves a double hit (two loci are mutant in the same strain).
3. Students create a mutant *coli* strain that is auxotrophic for methionine. Three students build plasmid DNA libraries from wild type DNA from the parental strain. Student A uses *EcoRI* to clone the restriction fragments. Student B uses *HindIII* and student C uses *XhoI*. Each transforms the auxotrophic mutant strain with their library. Student A gets lots of prototrophic colonies on minimal medium, while students B and C don't get any. Explain what might have happened. The student's control experiments indicate that the transformation protocol worked.
4. [Figure 5.4.4](#) shows how we can rescue an a⁻ strain with a plasmid carrying an a⁺ gene. Could we also rescue this strain by growing the cells on media containing Enzyme A (the product of the a⁺ gene)? How about the product of Enzyme A?

Chapter 5 Answers

1.
 - a. Mutagenize a wild type (auxotrophic) strain and screen for mutations that fail to grow on minimal media, but grow well on minimal media supplemented with proline.
 - b. Take mutants #1-#10 and characterize them, based on:
 - i. genetic mapping of the mutants (different locations indicate different genes);
 - ii. different response to proline precursors (a different response suggests different genes);
 - iii. complementation tests among the mutations (if they complement then they are mutations in different genes).
 - c. If the mutations are in different genes, the F₁ progeny would be wild type (able to grow on minimal medium without proline).
 - d. If the mutations are in the same gene, the F₁ progeny would NOT be wild type (unable to grow on minimal medium without proline).
2. There are many correct answers for this question. Here is one:

Mutant Strain	1	2	3	4	5	Mutant in Loci
1	-	No value	No value	No value	No value	Mutant in locus (1,2)
2	-	-	No value	No value	No value	Mutant in locus (1,2)
3	+	+	-	No value	No value	Mutant in locus (3)
4	+	+	+	-	No value	Mutant in locus (4)
5	+	+	-	-	-	Mutant in locus (3 and 4)

3. The auxotrophic strain is mutant in one gene. This gene has both a *Hind*III and *Xho*I site within its sequence, but not an *Eco*RI. Thus, the *Eco*RI library could contain a restriction fragment with an entire, intact gene, while the two other enzymes would break the gene into two fragments that would not be cloned together as a functional gene.
4. *E. coli* cells do not normally import proteins from their environments, thus none of the Enzyme A proteins would enter the cells to affect a rescue. If the product of Enzyme A was added, then it could rescue the strain, but only if the product could be taken up by the cells.

CHAPTER 6 - ALLELES AT A SINGLE LOCUS

6.1 Introduction

Learning Objectives

- Discuss what is meant by “Extensions and Modifications of Basic Principles of Mendelian Genetics”.
- Identify additional factors at a single locus and the effect on the results of genetic crosses.
- Describe the various types of dominance, lethal alleles and pleiotropic genes.
- State the molecular conditions required to produce “Muller’s Morphs”.

Mendelian inheritance describes inheritance patterns that obey two laws – the Law of Segregation and the Law of Independent Assortment. Simple Mendelian inheritance involves a single gene with two different alleles, and alleles which display a simple dominant/recessive relationship. We will examine traits that deviate from the simple dominant/recessive relationship – the inheritance patterns of these traits still obey Mendelian laws, however, they are more complex and interesting than Mendel had realized. In this chapter, we will investigate the interactions of alleles at a single locus. We will begin with the difference between somatic and germ line mutations, followed by the concept of Pleiotropy. Then, we will look at the various types of dominance, followed by the Biochemical basis of dominance. Finally, we will end with more sophisticated interactions that can be described by “Muller’s Morphs”, which deal with the interrelationships of mutant and wild type alleles at a more detailed level.

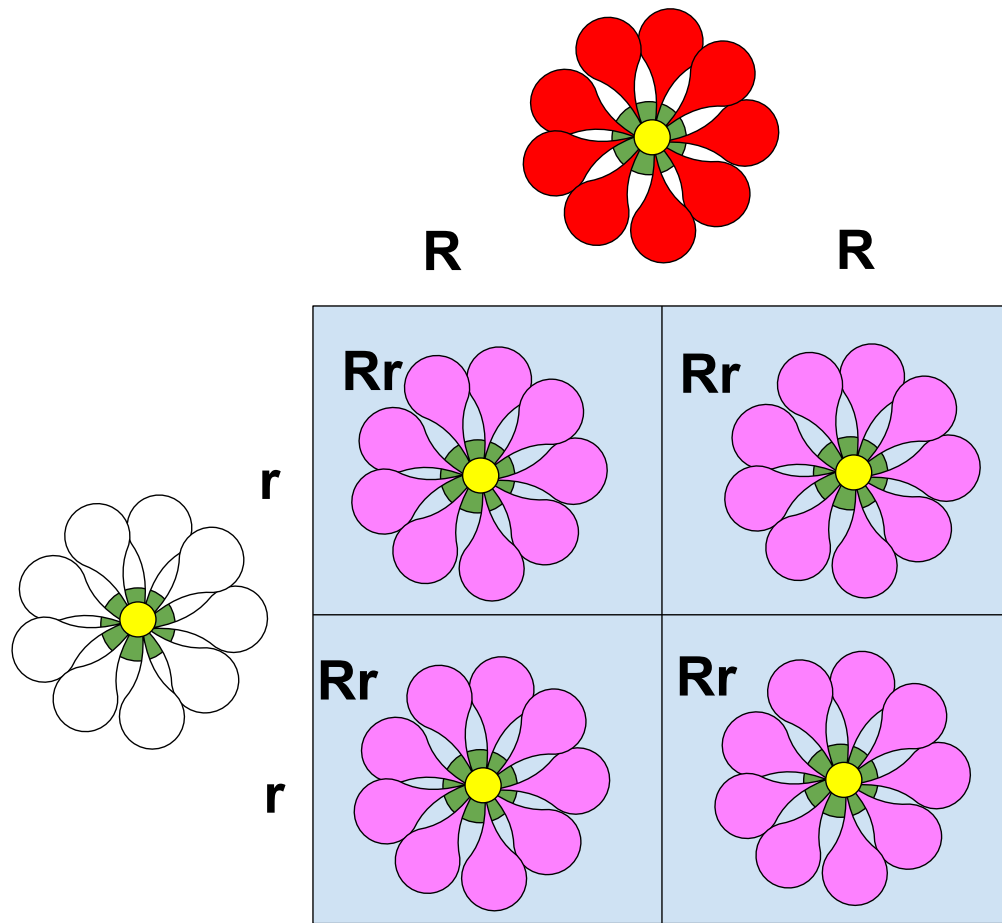

Figure 6.1.1 Incomplete Dominance [Long description]

A specific section of a chromosome is called a **locus**. Because each gene occupies a specific locus along a chromosome, the terms locus and gene are often used interchangeably. However, the term “gene” is a much more general term, while “locus” usually is limited to defining the position along a chromosome. Each locus will have an allelic form (allele); that is, a specific DNA sequence. In a population of individuals, there will be sequence variation so there will be different alleles. Some may be defined as wild type, some as variants, others as mutant. The complete set of alleles at all loci in an individual is its **genotype**. Typically, when writing out a genotype, only the alleles at the locus (or loci) of interest are considered and written down – all the others are still present and assumed to be wild type. So, usually only the alleles at the few mutant loci appear in the written genotype. All the many, many others that are wild type, are not. The visible or detectable effect of alleles on the structure or function of that individual is called its **phenotype** – what it looks like. The phenotype studied in any particular genetic experiment may range from simple, visible traits, such as hair color, to more complex phenotypes including disease susceptibility or behaviour. If two alleles are present in an individual, as is the case with diploid organisms, then various interactions between them may influence their expression in the phenotype.

Media Attribution

- **Figure 6.1.1** [Incomplete dominance](#) by Spencerbaron, [CC BY-SA 3.0](#), via Wikimedia Commons

Long Description

- **Figure 6.1.1** Incomplete dominance: A red-coloured flower is shown to be mated with a white-coloured flower. All offspring of this cross are pink flowered, indicating the production of the “intermediate” phenotype typically exemplified in incomplete dominance. [Back to [Figure 6.1.1](#)]

6.2 Somatic vs. Germline Mutations

A mutation occurs in the DNA of a single cell. In single-cell organisms, that mutation is passed on directly to its descendants, typically through the process of mitosis. In multicellular animals, there is a partitioning early in development into **somatic cells**, which form the body cells, and **germline cells**, which form the gametes for the next generation. Mutations may be passed on to somatic cells via mitosis and to gametes via meiosis. In plants, this somatic/germline separation occurs later in the cells that form the flower.

Somatic Mutations

Somatic cells form the tissues of the organism and are not passed on as gametes. Any mutations in somatic cells will only affect the individual in which they occur, not its progeny. If mutations occur in somatic cells, its mutant descendants will exist alongside other non-mutant (wild type) cells. If the mutation occurs at a very early stage of development, the mutation will be present in more cells. This gives rise to an individual composed of two or more types of cells that differ in their genetic composition. Such an individual is said to be a **mosaic**. An example is shown in **Figure 6.2.1** Cancer cells are another example of mosaicism.



Figure 6.2.1 Segmental Heterochromia in Left Eye (shown right). [[Long description](#)]

Germline Mutations

Germline cells are those that form the eggs or sperm cells (ovum or pollen in plants), and are passed on to form the next generation. Therefore, mutations in germline cells will be passed on to the next generation but won't affect the individual in which they occur.

In animals, somatic cells are segregated from germ line cells. In plants, somatic cells become germline cells; so somatic mutations can become germline mutations.

Take a look at the video below, *2H – Somatic & germline mutations*, presented by Professor Redfield of UBC (Useful Genetics, 2015) on YouTube, which explains Somatic and Germline mutations.



A YouTube element has been excluded from this version of the text. You can view it online here:

<https://opengenetics.pressbooks.tru.ca/?p=670>

Haploid vs. Diploid Organisms

Haploid organisms, have only one copy of a gene, thus a mutation will directly affect the organism's phenotype. Therefore, the phenotype can be used to directly infer the genotype of the organism.

However, in diploid organisms, there are two copies of each gene. The phenotype depends upon an interaction between the two alleles. Thus, any mutation may not have a direct impact on the organism's phenotype. The interaction of the two alleles can show complete dominance, incomplete dominance, co-dominance, or recessiveness. Therefore, inferring the genotype based upon its phenotype is not as simple as in diploids.

Watch the video below, *The Life Cycle of Yeast* – Professor Rhona Borts, from University of Leicester (2010) on YouTube.



A YouTube element has been excluded from this version of the text. You can view it online here:

<https://opengenetics.pressbooks.tru.ca/?p=670>

Media Attribution

- **Figure 6.2.1** [Segmental heterochromia in left eye](#) by [Jvedral](#), [CC BY-SA 4.0](#), via Wikimedia Commons

References

Redfield, R./UBC [Useful Genetics]. (2015, August 10). 2H – Somatic & germline mutations (video file). YouTube.
<https://www.youtube.com/watch?v=bSPBow616f8>

University of Leicester. (2010, November 19). The life cycle of yeast – Professor Rhona Borts (video file). YouTube.
<https://youtu.be/XxDlzMARURE>

Long Description

- **Figure 6.1.1** A pair of human eyes. Left eye colour is blue-grey and right eye colour is shown to be mosaic, with two colours shown – blue-grey and orange. This is an example of segmental heterochromia. [Back to [Figure 6.2.1](#)]

6.3 Alleles: Hetero-, Homo-, Hemizyosity

Mendel's First Law (segregation of alleles) is especially remarkable because he made his observations and conclusions (1865) without knowing about the relationships between genes, chromosomes, and DNA. We now know the reason why more than one allele of a gene can be present in an individual; most eukaryotic organisms are diploid and have at least two sets of homologous chromosomes. For organisms that are predominantly diploid, such as humans or Mendel's peas, chromosomes exist as pairs, with one copy inherited from each parent. Diploid cells, therefore, can contain two different alleles of each gene, with one allele part of each member of a pair of homologous chromosomes. If both alleles of a particular gene are the same (indistinguishable), the individual is said to be **homozygous** at that gene or locus. On the other hand, if the alleles are different (can be distinguished) from each other, the genotype is **heterozygous**. In cases where there is only one copy of a gene present, for example if there is a deletion of the locus on the homologous chromosome, we use the term **hemizygous**. Another example is the single X-chromosome in X/Y males, where almost all the loci on that chromosome are hemizygous.

Although a single diploid individual can have at most two different alleles of a particular gene, many more alleles can exist in a population of individuals. In a natural population the most common allelic form is usually called the **wildtype** allele. However, in many populations there can be multiple **variants** at the DNA sequence level that are visibly indistinguishable as all exhibit a normal, wild type appearance. There can also be various **mutant** alleles (in wild populations and in lab strains) that vary from wild type in their appearance, each with a different change at the DNA sequence level. The many different mutations (alleles) at the same locus are called an **allelic series** for a locus.

Take a look at the video below, *Homozygous, Heterozygous, Hemizygous, Haploid*, by Nikolay's Genetics Lessons (2015) on YouTube, which discusses the terms homozygous, heterozygous, hemizygous and haploid.

Which of these describes an organism that has the genotype Bb?

A. Homozygous dominant BB

B. Homozygous recessive bb

C. Hemizygous

D. None of these

A white mouse whose parents are both white produces only brown offspring when mated with a brown mouse. The white mouse is probably

A. Homozygous dominant

B. Homozygous recessive

C. Heterozygous

D. Haploid

A YouTube element has been excluded from this version of the text. You can view it online here:

<https://opengenetics.pressbooks.tru.ca/?p=676>

Reference

Nikolay's Genetics Lessons. (2015, September 9). Homozygous, heterozygous, hemizygous, haploid (video file). YouTube. <https://www.youtube.com/watch?v=tUV90q6pzOU>

6.4 Pleiotropy vs. Polygenic Inheritance

There is usually not a one-to-one correspondence between a gene and a physical characteristic. Often a gene is responsible for several phenotypic traits and it is said to be **pleiotropic**. Pleiotropy occurs when one gene influences two or more seemingly unrelated phenotypic traits. Such a gene that exhibits multiple phenotypic expression is called a pleiotropic gene. For example, mutations in the vestigial gene (*vg*) in *Drosophila* results in an easily visible short wing phenotype. However, mutations in this gene also affect the number of egg strings, position of the bristles on scutellum, and lifespan in *Drosophila*. Therefore, *vg* gene is said to be pleiotropic in that it affects many different phenotypic characteristics. During his study of inheritance in pea plants, Mendel made several interesting observations regarding the colour of various plant components. Specifically, Mendel noticed that plants with coloured seed coats always had coloured flowers and coloured leaf axils – axils are the parts of the plant that attach leaves to stems. Mendel also observed that pea plants with colourless seed coats always had white flowers and no pigmentation on their axils. In other words, in Mendel's pea plants, seed coat colour was always associated with specific flower and axil colours. Today, we know that Mendel's observations were the result of pleiotropy, or the phenomenon in which a single gene contributes to multiple phenotypic traits. In this case, the seed coat colour gene, denoted *a*, was not only responsible for seed coat colour, but also for flower and axil pigmentation.

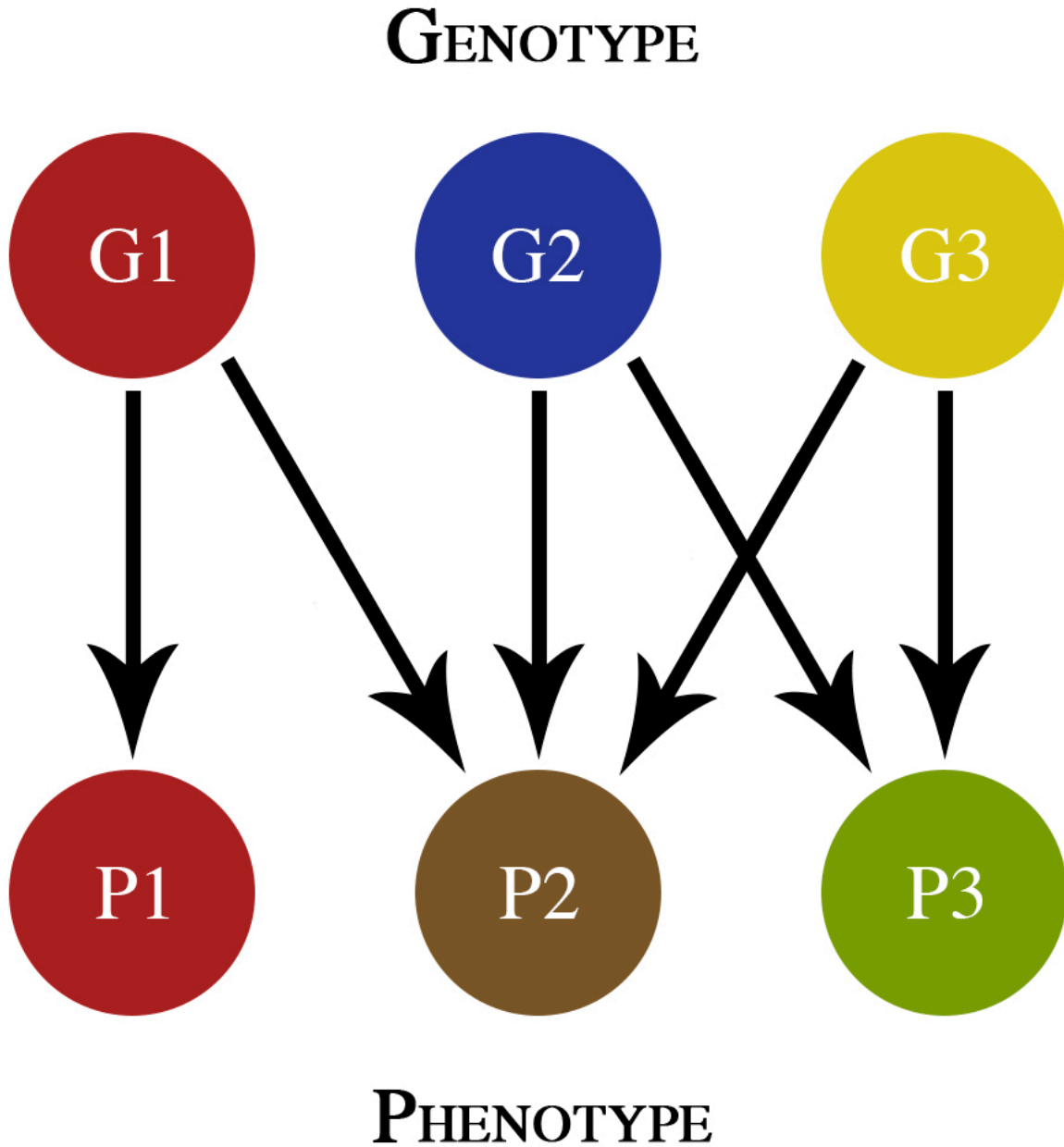

Figure 6.4.1 Possible Relationships Between Genes and Phenotypes [[Long description](#)]

On the other hand, single characteristics can be affected by mutations in multiple, different genes. This implies that many genes are needed to make each characteristic. For example, if we return to the *Drosophila* wing, there are dozens of genes that when mutant alter the normal shape of the wing, not just the *vg* locus. Thus there are many genes that are needed to make a normal wing; the mutation of any one causes an abnormal, mutant, phenotype. This type of arrangement is called **polygenic inheritance**.

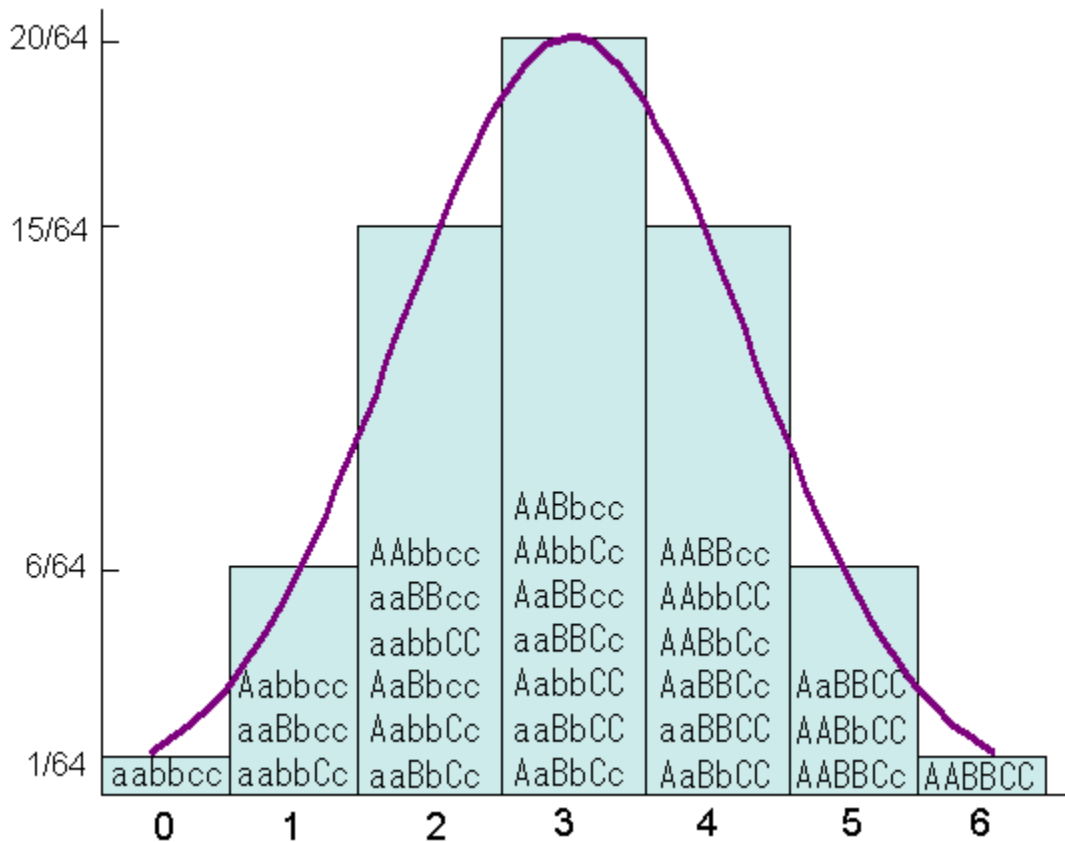

Figure 6.4.2 Typical Distribution of Phenotypes in Polygenic Inheritance. Traits that display a continuous distribution, such as height or skin color, are polygenic. [\[Long description\]](#)

Media Attributions

- **Figure 6.4.1** [Simple Genotype Phenotype Map](#) by Alphilips6, [CC BY-SA 4.0](#), via Wikimedia Commons
- **Figure 6.4.2** [Polygene00](#) by Maulits, [CC BY-SA 4.0](#), via Wikimedia Commons

Long Descriptions

- **Figure 6.4.1** Pleiotropy occurs when one gene influences two or more seemingly unrelated phenotypic traits. This relationship between genes and phenotypes is demonstrated by mapping one genotype; e.g., G1 to multiple phenotypes; e.g.; P1 and P2. [\[Back to Figure 6.4.1\]](#)
- **Figure 6.4.2** A bell curve showing the typical distribution of phenotypes in Polygenic Inheritance. On the extreme left and the extreme right of the curve, a small frequency of outlier genotypes are represented. As the curve approaches the middle, the frequency of more common genotypes increases. At the very centre of the curve, a maxima is achieved, producing the typical bell shaped graph. [\[Back to Figure 6.4.2\]](#)

6.5 Types of Dominance

As we discussed in the previous section on polygenic traits, in humans most characteristics do not fit into two different phenotypes – complex traits, e.g., height, hair texture, skin colour etc., seemingly do not follow Mendelian analysis. As more scientists began analyzing genetic crosses using different types of plants and animals, it was found that while some traits obeyed Mendel's laws (they were determined by a single gene with 1 dominant and 1 recessive allele), many other traits did not. In such cases, there were no definite recessive or dominant traits observed, or more than two alleles identified in a particular cross. In some instances, traits seem to be determined by more than one gene (multifactorial), and the environment also seemed to play a role through interaction with genes, to produce varying phenotypes.



Figure 6.5.1 Colour, Shape, and Size of Tomatoes are Examples of Multifactorial Traits [[Long description](#)]

These examples of the behaviour of certain traits implies a more complex array of interactions are at play, as these do not generate the typical Mendelian phenotypic ratios. We are extending Mendel's Laws in order to provide explanations for the behaviour of such traits, and not necessarily challenging them.

One of the first concepts we need to understand, is that dominance is not always complete. Thus far, we have looked at the concept of dominance and recessiveness, whereby these conditions arise upon crossing two pure-breeding lines to create hybrids, and the hybrids are identical in phenotype to one parent for the particular trait in question. In this simplistic case, the allele passed down by that parent is said to be completely dominant when compared with the allele passed down by the parent whose trait is not manifested in the hybrid offspring. This type of arrangement is termed **complete dominance**.

As we will now see, there are two other types of Dominance – namely, **incomplete dominance** and **co-dominance**.

Complete Dominance

An example of a simple phenotype, is flower color in Mendel's peas. We have already said that one allele as a homozygote produces purple flowers, while the other allele as a homozygote produces white flowers. But what about a heterozygous individual that has one purple allele and one white allele? What is the phenotype of a heterozygote?

This can only be determined by experimental observation. We know from observation that individuals heterozygous for the purple and white alleles of the flower colour gene have purple flowers. Thus, the allele associated with purple colour is, therefore, said to be **dominant** to the allele that produces the white colour. The white allele, whose phenotype is masked by the purple allele in a heterozygote, is **recessive** to the purple allele. The dominant/recessive character is a relationship between two alleles and must be determined by observation of the heterozygote phenotype.

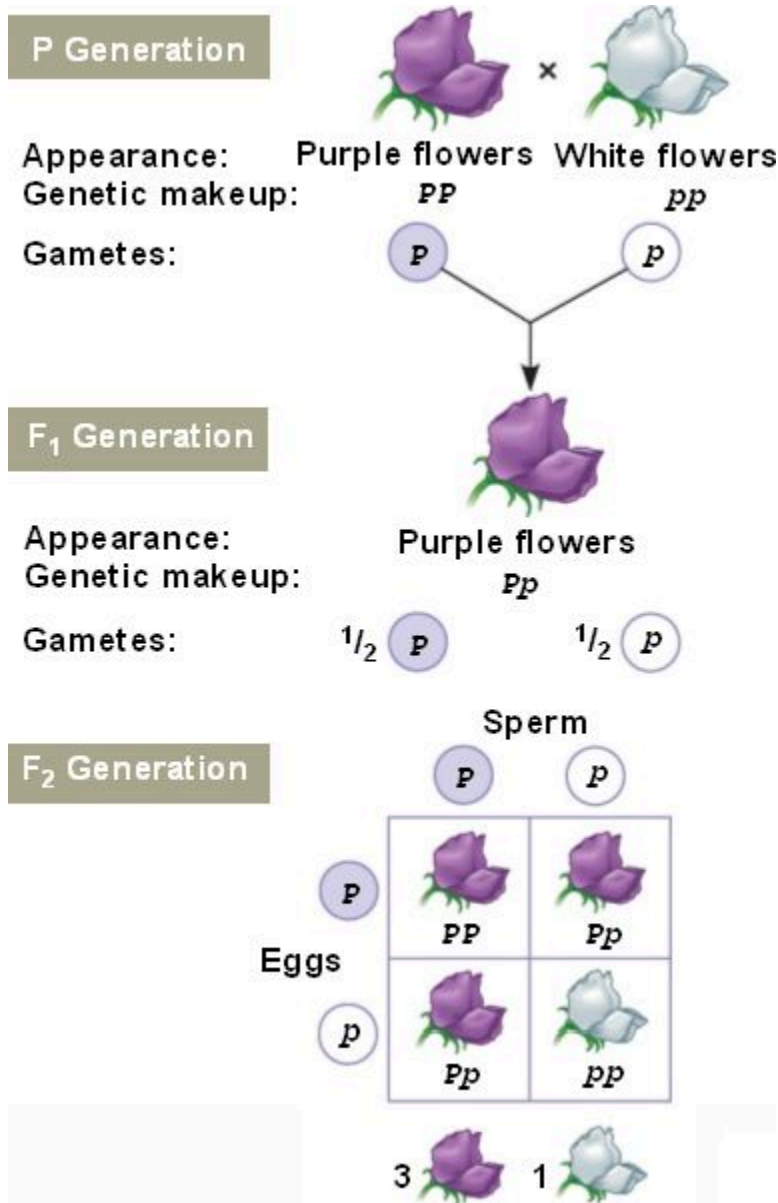

Figure 6.5.2 Allele for Purple Flowers (P) is Completely Dominant Over Allele for White Flowers (p) [[Long description](#)]

Sometimes, to represent this relationship, a dominant allele will be written as a capital letter (e.g., A) while a recessive allele will be written in lower case (e.g., a). However, this is not the only system. Many different systems of genetic symbols are in use. The most common are shown in **Table 6.5.1** Also note, genotypes (alleles) are usually written in *italics* and chromosomes and proteins are not. For example, the *white* gene in *Drosophila melanogaster* on the X chromosome encodes a protein called WHITE, which is a pigment precursor transmembrane transporter enzyme.

Table 6.5.1 Examples of Symbols Used to Represent Genes and Alleles

Examples	Interpretation
A and a	Uppercase letters represent dominant alleles and lowercase letters indicate recessive alleles. Mendel invented this system but it is not commonly used because not all alleles show complete dominance and many genes have more than two alleles.
a^+ and a^1	Superscripts or subscripts are used to indicate alleles. For wild type alleles the symbol is a superscript +.
AA or A/A	Sometimes a forward slash is used to indicate that the two symbols are alleles of the same gene locus, but on homologous chromosomes.

Take a look at the video below. *Incomplete Dominance, Codominance, Polygenic Traits, Epistasis*, by Amoeba Sisters (2015) on YouTube, which discusses the various types of dominance and polygenic traits.

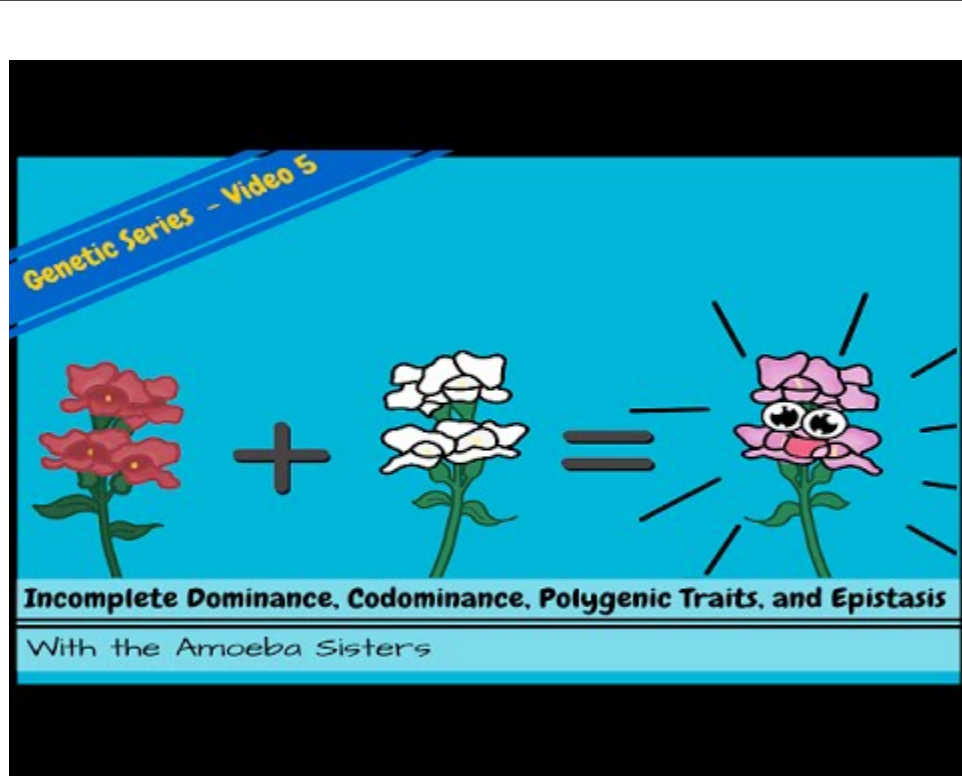

A YouTube element has been excluded from this version of the text. You can view it online here:

<https://opengenetics.pressbooks.tru.ca/?p=684>

Incomplete Dominance

Other than the complete dominant and recessive relationship, other relationships can exist between alleles. In **incomplete dominance** (also called **semi-dominance**), both alleles affect the trait additively, and the phenotype of the heterozygote shows a typically intermediate between the homozygotes, which is often referred to as blended phenotype. For example, alleles for colour in carnation flowers (and many other species) exhibit incomplete dominance. Plants with alleles for red petals (RR) when crossed with a plant with alleles for white petals (rr) have offspring which have pink petals (Rr). We say that the R and the r alleles show incomplete dominance because neither allele is completely dominant over the other (**Figure 6.5.3**). Even though in **Figure 6.5.3**, there is the use of capital and common letters to indicate the two incompletely dominant alleles, a better way to represent such alleles would be the use of superscripts on the same letter e.g., R^1 and R^2 .

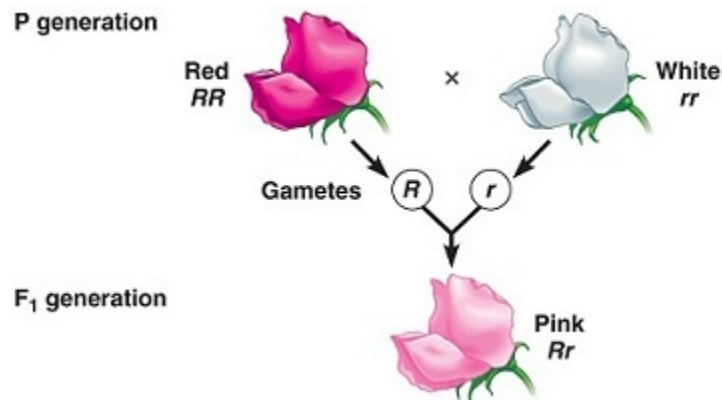

Figure 6.5.3 Incomplete Dominance (Blended Phenotype Produced) [[Long description](#)]

Co-Dominance

Co-dominance is another type of allelic relationship in which a heterozygous individual expresses the phenotype of both alleles simultaneously. An example of co-dominance is found within the **ABO blood group** of humans. The ABO gene has three common alleles that were named (for historical reasons) I^A , I^B , and i . People homozygous for I^A or I^B display only A or B type antigens, respectively, on the surface of their blood cells, and therefore, have either type A or type B blood (**Figure 6.5.4**). Heterozygous $I^A I^B$ individuals have both A and B antigens on their cells, and so have type AB blood. Note that the heterozygote expresses both alleles simultaneously, and is not some kind of novel intermediate between A and B. Co-dominance is, therefore, distinct from incomplete dominance, although they are sometimes confused.

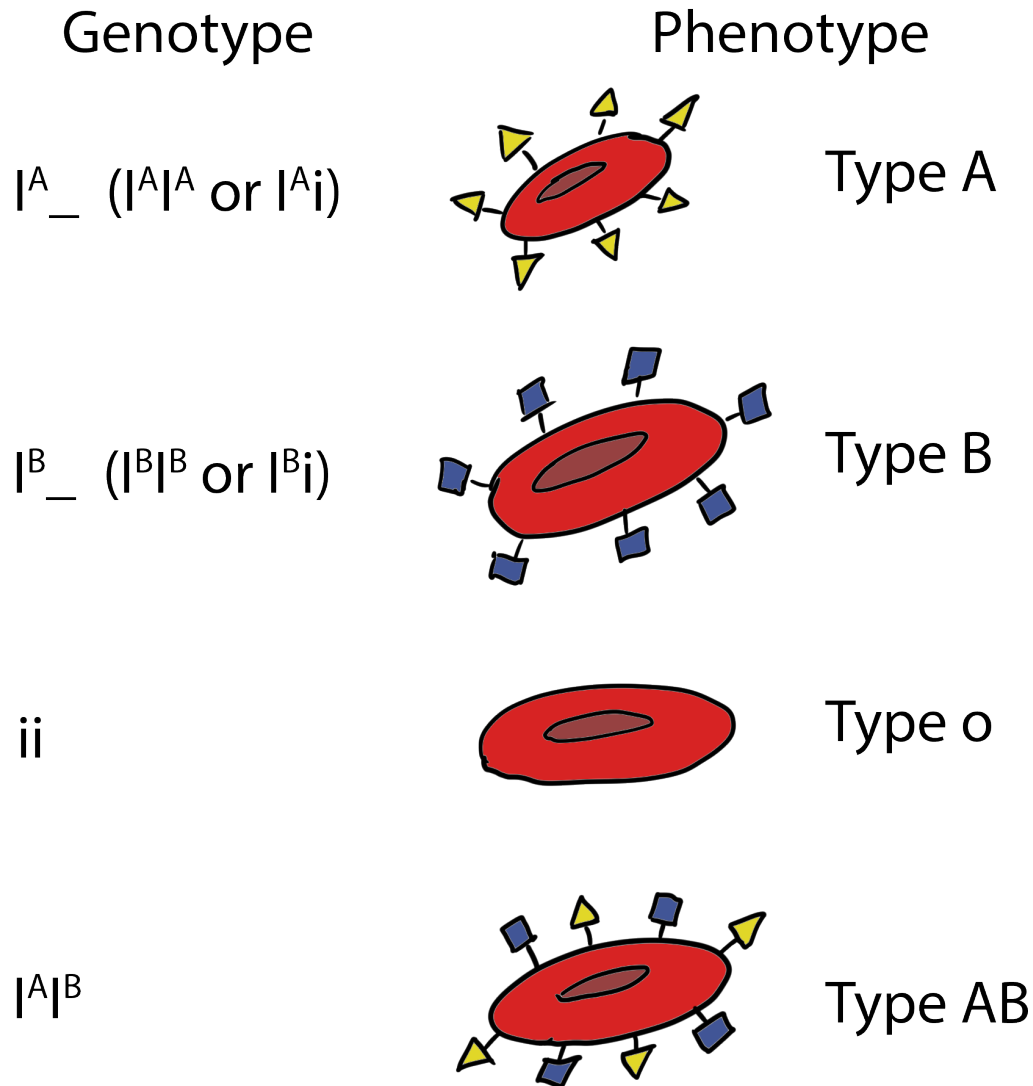

Figure 6.5.4
Co-Dominance Exhibited
by Human Blood Groups
[\[Long description\]](#)

It is also important to note that the third allele, *i*, does not make either antigen and thus is recessive to the other alleles. I^A/i or I^B/i individuals display only A or B antigens, respectively. People homozygous for the *i* allele have type O blood.

This is a useful reminder that different types of dominance relationships can exist, even for alleles of the same gene.

Media Attributions

- **Figure 6.5.1** [2013_09_10_Tomate](#) by Friedrich Haag, [CC-BY-SA-4.0](#), via Wikimedia Commons
- **Figure 6.5.2** [14_05LawOfSegregation_2_L](#) by Ashinkaaa, [CC BY-SA 4.0](#), via Wikimedia Commons
- **Figure 6.5.3** [09_11aIncompleteDominance-L](#) by RudLus02, [CC BY-SA 4.0](#), via Wikimedia Commons
- **Figure 6.5.4** [Blood Type Codominance](#) by DylanAudette, [CC0 1.0 Universal Public Domain](#), via Wikimedia Commons

References

Amoeba Sisters. (2015, May 25). Incomplete dominance, codominance, polygenic traits, and epistasis! (video file). YouTube. <https://www.youtube.com/watch?v=YJHGfbW55l0>

Long Descriptions

- **Figure 6.5.1** Two tomatoes: one is large and red in colour, and the other is small and orange in colour. The image seeks to demonstrate the variety of phenotypes that are possible with multifactorial traits, which are determined by more than one gene. [Back to [Figure 6.5.1](#)]
- **Figure 6.5.2** Cross to demonstrate complete dominance. P generation is pure bred purple flowers crossed with pure breeding white flowers, resulting in all purple flowers (heterozygous) in the F1 generation. The F2 generation produces flowers in a ratio of 3 purple to 1 white, which is typical of complete dominance in a monohybrid cross. [Back to [Figure 6.5.2](#)]
- **Figure 6.5.3** Cross to demonstrate incomplete dominance. P generation is pure-bred red flowers crossed with pure breeding white flowers. The F1 generation produced is comprised of pink flowers only, which is indicative of incomplete dominance between these two alleles controlling flower colour. [Back to [Figure 6.5.3](#)]
- **Figure 6.5.4** The variety of blood types in humans. Four phenotypes are shown which are A, B, O and AB. These phenotypes are the result of combinations of alleles which exemplify co-dominance (A and B) as well as alleles which exemplify complete dominance (A and B over O). The combinations of alleles result on specific antigens being expressed on red blood cells of that organism, resulting in the four typical blood group phenotypes seen in humans. [Back to [Figure 6.5.4](#)]

6.6 Biochemical Basis of Dominance

Given that a heterozygote's phenotype cannot simply be predicted from the phenotype of homozygotes, what does the type of dominance tell us about the biochemical nature of the gene product? How does dominance work at the biochemical level? There are several different biochemical mechanisms that may make one allele dominant to another.

For the majority of genes studied, the normal (i.e., wild-type) alleles are **haplo-sufficient**. So in diploids, even with a mutation that causes a complete loss of function in one allele, the other allele – a wild-type allele – will provide sufficient normal biochemical activity to yield a wild type phenotype and thus be dominant and dictate the heterozygote phenotype.

On the other hand, in some biochemical pathways, a single wild-type allele is not enough protein and may be **haplo-insufficient** to produce enough biochemical activity to result in a normal phenotype, when heterozygous with a non-functioning mutant allele. In this case, the non-functional mutant allele will be dominant (or semi-dominant) to a wild-type allele.

Mutant alleles may also encode products that have new and/or different biochemical activities instead of, or in addition to, the normal ones. These **novel activities** could cause a new phenotype that would be dominantly expressed.

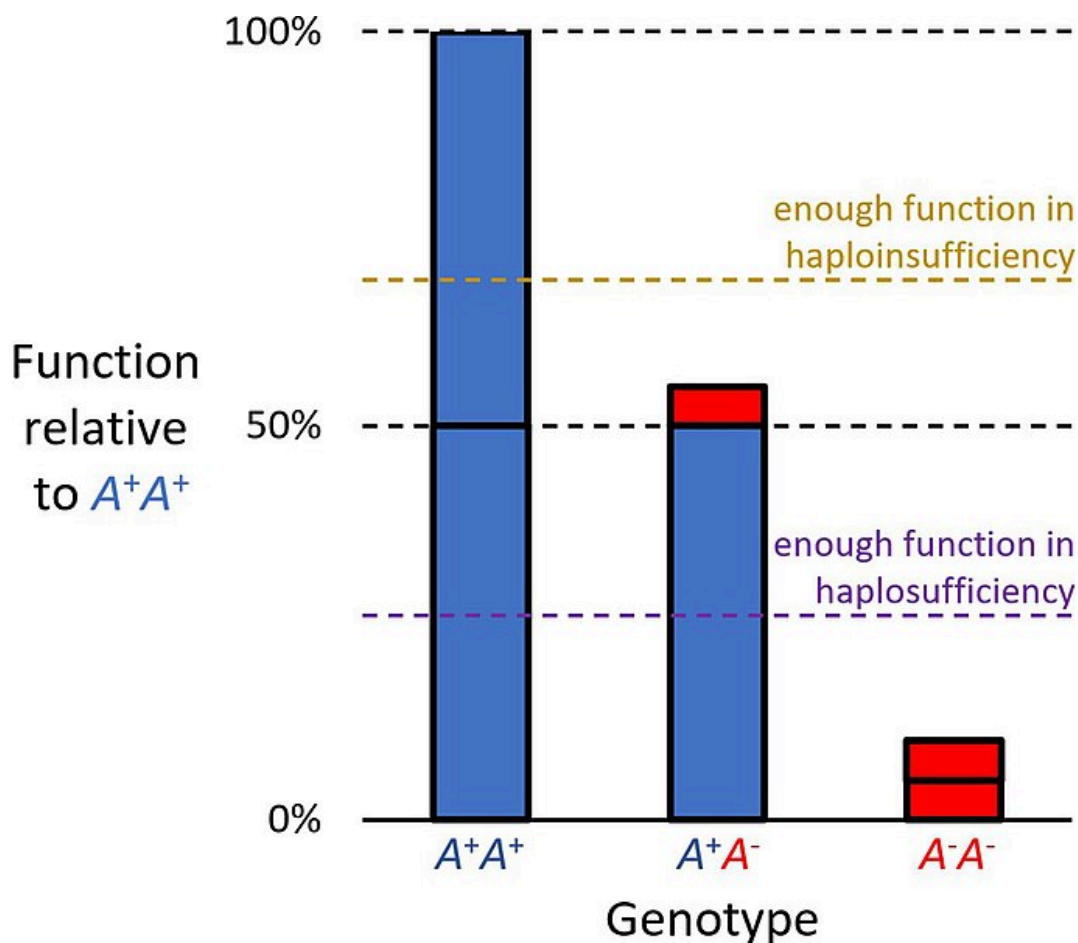

Figure 6.6.1 Graph Showing the Haploinsufficiency Model of Dominant Genetic Disorders. A^+ is a normal allele. A^- is a mutant allele with little or no function. In haplosufficiency (most genes), a single normal allele provides enough function, so A^+A^- individuals are healthy. In haploinsufficiency, a single normal allele does not provide enough function, so A^+A^- individuals have a genetic disorder. [[Long description](#)]

Media Attribution

- **Figure 6.6.1** [Haploinsufficiency graph only](#) by [Adrian J. Hunter](#), [CC BY-SA 4.0](#), via Wikimedia Commons

Long Description

- **Figure 6.6.1** The haploinsufficiency model of dominant genetic disorders: A⁺ is a normal allele and A⁻ is a mutant allele with little or no function. In haplosufficiency (most genes), a single normal allele provides enough function, so A⁺A⁻ individuals are healthy. In haploinsufficiency, a single normal allele does not provide enough function, so A⁺A⁻ individuals have a genetic disorder. [Back to [Figure 6.6.1](#)]

6.7 Classification of Mutants

Previously, we looked at complementation groups and we understood how mutations can work together (or not) to produce different phenotypes. In this section, we will look at the various types of mutations that can arise in cells: morphological, lethal, biochemical and conditional. The final type, known as Muller's Morphs, will be discussed in the next section.

Morphological Mutants

Morphological mutations cause changes in the visible form of the organism as they give rise to altered forms of a trait e.g., change in size, shape (normal wing vs. curly wing in fruit flies), colour, number etc.



Figure 6.7.1 Examples of Morphological Mutations in Dogs [[Long description](#)]

Lethal Mutants

A lethal mutation causes the premature death of an organism. For example, in *Drosophila*, lethal mutations can result in death during the embryonic, larval, or pupal stage. Lethal mutations are usually recessive, so both copies of a gene must be lost for premature death to occur (homozygous lethal alleles will not be viable). Heterozygotes, which have one lethal allele and one wild type allele, are typically viable. In the example shown in **Figure 6.7.2** regarding yellow coat colour in mice, the lethal allele is recessive because it causes death only in homozygotes. Unlike its effect on survival, the effect of the allele on colour is dominant. In mice, a single copy of the allele in heterozygotes produces a yellow colour. These examples illustrate the point that the type of dominance depends on the aspect of the phenotype examined.

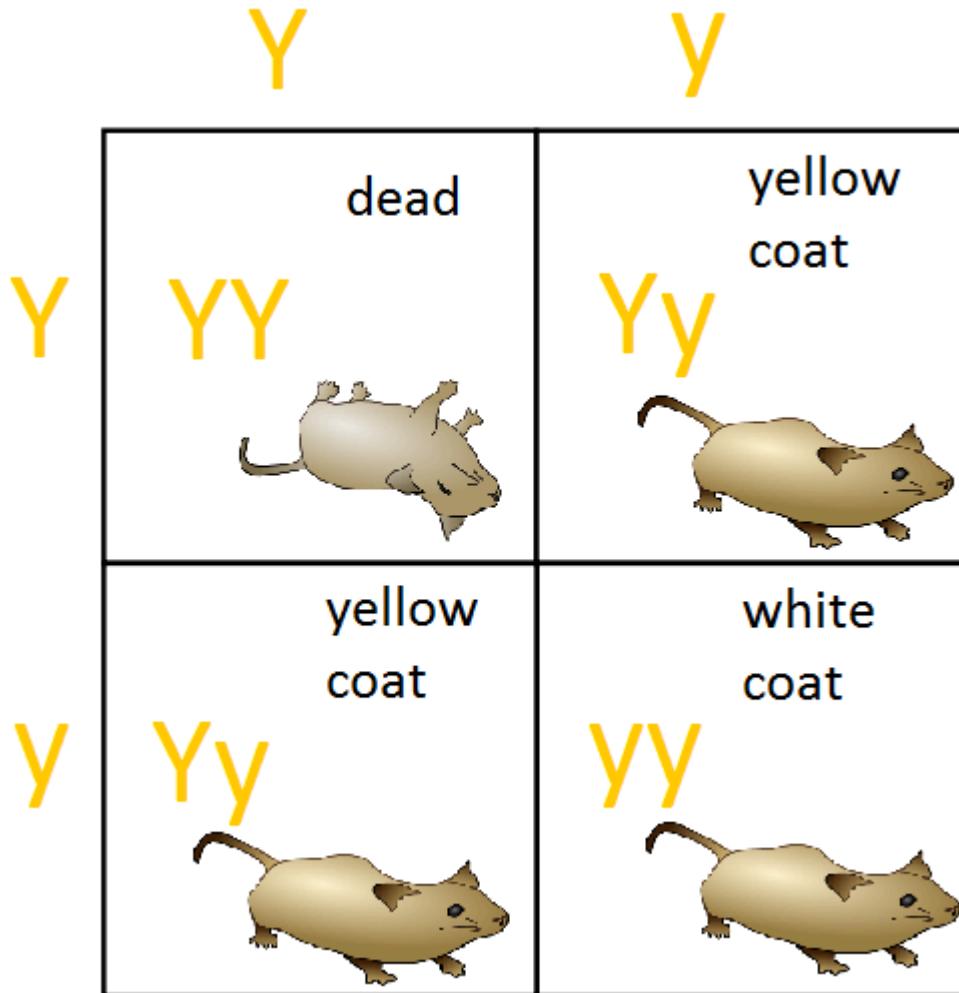

Figure 6.7.2 Punnett Square Showing Effect of a Lethal Allele in Mice
[\[Long description\]](#)

Biochemical Mutants

Auxotrophic mutants can be derived from prototrophic parents. This type of mutation blocks a step in a biochemical pathway for the *arg-* mutants of Beadle and Tatum. Such biochemical mutations are a specific type of the conditional mutation class. Biochemical mutants result in the inability to carry out a specific biochemical pathway.

Growth Data

Figure 6.7.3 Data Derived by Beadle and Tatum on Biochemical Mutants [\[Long description\]](#)

Mutant	Growth of mutant on minimal medium supplemented with:				
	Nothing	Ornithine	Citrulline	Arginino-succinate	Arginine
<i>Arg</i> ⁺	+	+	+	+	+
<i>ArgE</i> ⁻	-	+	+	+	+
<i>ArgF</i> ⁻	-	-	+	+	+
<i>ArgG</i> ⁻	-	-	-	+	+
<i>ArgH</i> ⁻	-	-	-	-	+

+ fungus grows on this medium
 - fungus fails to grow on this medium

Conditional Mutants

Conditional mutations rely on the concept of: phenotype = genotype + environment + interaction. Organisms with this mutation express a mutant phenotype, but only under specific environmental conditions. Under **restrictive conditions**, they express the mutant phenotype, while under **permissive conditions**, they show a wild type phenotype. One example of a conditional mutation is the temperature-sensitive pigmentation of Siamese cats. Siamese cats have temperature sensitive fur colour; their fur appears unpigmented (light coloured) when grown in a, warm temperature environment. The hair appears pigmented (dark) when grown at a cooler temperature. This is seen at the peripheral regions of the feet, snout, and ears (**Figure 6.7.4**). This is because in warm temperatures, the enzyme needed for melanin pigment synthesis becomes nonfunctional. However, in cooler temperatures, the enzyme needed for melanin synthesis is functional, and the deposition of melanin makes the fur look dark.



Figure 6.7.4 Siamese Cats Showing Temperature Sensitive Fur Colour
[\[Long description\]](#)

Media Attributions

- **Figure 6.7.1** [Dog morphological variation](#) by Mary Bloom, American Kennel Club, [CC BY-SA 4.0](#), via Wikimedia Commons
- **Figure 6.7.2** [Lethal alleles punnett square](#) by Dead_mouse.svg and Mouse.svg: Madprime derivative work: Adabow, [CC BY-SA 3.0](#), via Wikimedia Commons
- **Figure 6.7.3** [Beadle and Tatum data](#) by Allen Gathman is licensed under [CC BY-NC-SA 2.0](#), via Flickr
- **Figure 6.7.4** [Two Siamese Cats](#) by Steve Gilham is licensed under [CC BY-NC-SA 2.0](#), via Flickr

Long Descriptions

- **Figure 6.7.1** Six different dogs, each of different species, display a wide range of physical attributes that point to morphological mutations, such as differences in fur colour and texture, tail length, height of limbs, facial features, ear presentation, etc. [[Back to Figure 6.7.1](#)]
- **Figure 6.7.2** A Punnett square shows the production of offspring from two parents, both of which carry the allele dominant for coat colour but recessive for lethality. Both parents are genotype Yy; both display a yellow coat colour. In the offspring, there is a 3:1 ratio of living to dead progeny, with the accumulation of the YY alleles in one-out-of-four offspring results in death. Yy in the offspring (50%) display yellow coat colour and are alive, and yy offspring (25%) display white coat colour, which is recessive to yellow, and are alive. [[Back to Figure 6.7.2](#)]
- **Figure 6.7.3** Growth data demonstrated for various mutants and corresponding minimal media alone or media supplemented with various nutrients including nothing, ornithine, citrulline, arginosuccinate and arginine. The ability of the various mutants to grow in different types of media is indicated by a plus sign, and no growth is represented by a negative sign. This information represents the data derived by Beadle and Tatum on biochemical mutants. [[Back to Figure 6.7.3](#)]
- **Figure 6.7.4** Two Siamese cats display temperature sensitive colour, which is an example of conditional mutations, whereby the environment dictates the phenotype expressed. Their fur appears unpigmented (light coloured) when grown in a warm temperature environment. The fur appears pigmented (dark) when grown at a cooler temperature. This is seen at the peripheral regions of the feet, snout, and ears. [[Back to Figure 6.7.4](#)]

6.8 Muller's Morphs

In this section, we will discuss the final class of mutants, called Muller's Morphs. Most DNA sequence changes (mutations) occur at essentially random locations along a chromosome. Of those mutations occurring within genes, their mutant phenotypes (often recovered through genetic screens) are caused by **loss-of-function alleles**. These alleles are due to sequence changes in the DNA that cause a gene to produce fewer, less active, or non-active product (typically a protein), compared to the wild-type allele. Loss-of-function alleles tend to be recessive because the wildtype allele is haplo-sufficient. A loss-of-function allele that produces no active product is called an **amorphs**, or **null**, while alleles with only a partial loss-of-function are called **hypomorphs**.

More rarely, a mutant may have a **gain-of-function allele**, producing either more of the active product (**hypermorphs**) or producing an active product with a new and different function (**neomorphs**). Finally, **antimorphs** alleles have an activity that is dominant and opposite to the wild-type product's function; antimorphs are also known as **dominant negative** mutations.

Thus, mutations (changes in a gene sequence) can result in mutant alleles that no longer produce the same level or type of active product as the wild-type allele. Any mutant allele can be classified into one of five types: (1) amorph, (2) hypomorph, (3) hypermorph, (4) neomorph, and (5) antimorph.

Amorph

Amorphic alleles have a complete loss-of-function. They make no active product – zero function. They are known as a “**Null**” mutation or a “loss-of-function” mutation.

Molecular explanation: Changes in the DNA base pair sequence of an amorphic allele may cause one or more of the following:

1. Gene deletion – The DNA sequence is removed from the chromosome.
2. Gene is present, but is not transcribed because of a sequence change in the promoter or enhancer/regulatory elements.
3. Gene is present, but the transcript is aberrantly processed. There is normal transcription but base pair changes cause the mature mRNA to incorrectly splice introns, therefore the translated amino acid sequence would be altered and nonfunctional.
4. Gene is present and a transcript is produced but no translation occurs – changes in the base pair sequences would preclude the mRNA from binding to the ribosome for translation.
5. Gene is present and a transcript is produced and translated but a nonfunctional protein product is produced – the mutation alters a key amino acid in the polypeptide sequence producing a completely non-functional polypeptide.

Genetic/phenotypic explanation: Amorphic mutations of most genes usually act as recessive to wild type (Case #1). However, with some genes the amorphic mutations are dominant to wild type (Case #2).

Cases 1 & 2

case #1: white gene in Drosophila

Allele Combination	Result
w^+/w^+	wildtype and red eyed
w^+/w^-	wildtype and red eyed
w^-/w^-	mutant and white eyed

case #2: Minute locus in Drosophila

Allele Combination	Result
M^+/M^+	wildtype and long bristled
M^+/M^-	mutant and short bristled
M^-/M^-	dead, recessive lethal

For the *Minute* gene, we concluded that the organism needs both copies to have a wild type phenotype. Loss of one copy (an amorphic mutation) produces a dominant visible mutant phenotype. Deletion of the gene is an example of a classic amorphic mutation.

Hypomorph

Hypomorphic alleles show only a partial loss-of-function. These alleles are sometimes referred to as “**leaky**” mutations, because they provide some function, but not complete, normal function.

Molecular explanation: Changes in the DNA base pair sequence of the hypomorphic allele may cause one or more of the following, with the gene still present.

1. Reduced transcription – changed DNA sequence in the promoter or enhancer/regulatory elements can reduce the level of transcription.
2. Aberrant processing of the transcript – normal transcription but base pair changes cause the mature mRNA to incorrectly splice introns, therefore the translated protein sequence would be altered and function at a reduced level.
3. Reduced translation – changes in the base pair sequences would reduce the efficiency of the mRNA binding to the ribosome for translation.
4. Reduced-function protein product – normal transcription, processing, and translation, but mutation changes certain amino acid in the polypeptide sequence so its function is reduced.

Genetic/phenotypic explanation: Hypomorphic mutations of most genes usually act as recessive to wild type, though hypomorphic mutations theoretically could be dominant to wildtype.

Hypomorph

white-apricot allele in Drosophila

Allele Combination	Result
w^+/w^+	wildtype ad red eyed
w^+/w^a	wildtype and red eyed
w^a/w^a	mutant and apricot eye colour

Both amorphs and hypomorphs tend to be recessive to wild type in diploids because the wild type allele is usually able to supply sufficient product to produce a wild type phenotype (called **haplo-sufficient**). If the mutant allele is not able to produce a wild type phenotype, it is **haplo-insufficient**, and it will be dominant to the wild type allele. Here -/+ heterozygotes produce a mutant phenotype.

While the first two classes involve a **loss-of-function**, the next two involve a **gain-of-function** – quantity or quality. Gain-of-function alleles are almost always dominant to the wild type allele.

Hypermorph

Hypermorphic alleles produce quantitatively more of the same, active product.

Molecular explanation: Changes in the DNA base pair sequence of the hypermorphic allele may cause one or more of the following, with the gene still present.

1. Increased transcription – changed DNA sequence in the promoter or enhancer/regulatory elements that increase the level of transcription.
2. Increased translation – changes in the base pair sequences would increase the efficiency of the mRNA binding to the ribosome for translation.
3. Increased function protein product – normal transcription, processing, translation, but base pair changes alter certain amino acids in the polypeptide sequence, so its function is normal but increased in amount.

Genetic/phenotypic explanation: Hypermorphic mutations of most genes usually act as dominant to wild type since they are a gain of function, The classic hypermorph is a gene duplication.

Neomorph

Neomorphic alleles produce a product with a new, different function, something that the wild type allele does not do.

Molecular explanation: Changes in the DNA base pair sequence of the neomorphic allele may cause one or more of the following, with the gene still being present.

1. New transcription – changed DNA sequence in the promoter or enhancer/regulatory elements that makes new transcription either temporally or in a tissue-specific manner.

2. New function protein product – normal transcription, processing, translation but base pair changes alter certain amino acids in the polypeptide sequence so it acquires a new function (activity) that is different from the normal function (e.g., additional substrate or new binding site).

Genetic/phenotypic explanation: Most neomorphic mutations act dominant to wild type since they are a gain-of-function. The classical neomorphic mutation is a translocation that moves a new regulatory element next to a gene promoter so it is expressed in a new tissue or at a new time during development. Such mutations are often produced when chromosome breaks are rejoined and the regulatory sequences of one gene are juxtaposed next to the transcriptional unit of another, creating a novel, chimeric gene.

Antimorph

Antimorphic alleles are relatively rare, and have a new activity that is dominant and opposite to the wildtype function. These alleles usually interfere with the function from the wild type allele. (They often lose their normal function as well.) The new function works against the normal expression of the wild type allele. This can happen at the transcriptional, translational, or later level of expression. Thus, when an antimorphic allele is heterozygous with wild type, the wild type allele function is reduced or prevented. At the molecular level, there are many ways this can happen. The simplest model to explain an antimorphic effect is that the protein acts as a dimer (or any multimer) and the inclusion of a mutant subunit poisons the whole complex, thereby preventing or reducing its level of function. Antimorphs are also known as **dominant-negative** mutations because they are usually dominant and act negatively against the wild type function.

Identifying Muller's Morphs

All mutations can be sorted into one of the five morphs based on how they behave with heterozygous with three other standard alleles (**Figure 6.8.1**): (1) deletion alleles (zero function), (2) wild type alleles (normal function), and (3) duplication alleles (double normal function).

(a) Wild type – normal function

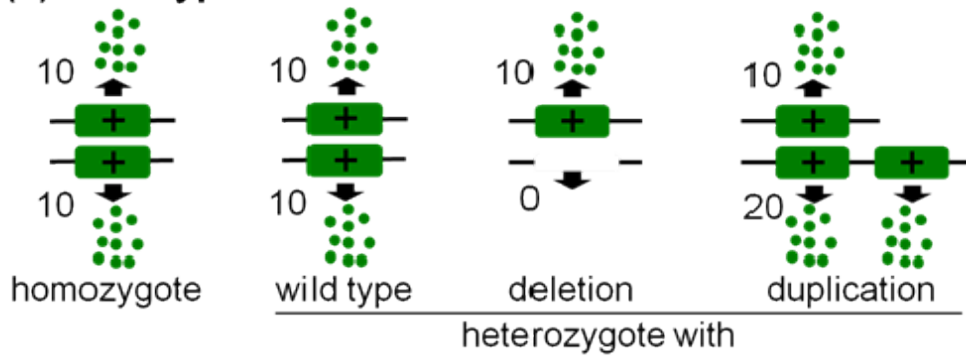

(b) Amorph – null – loss of all function

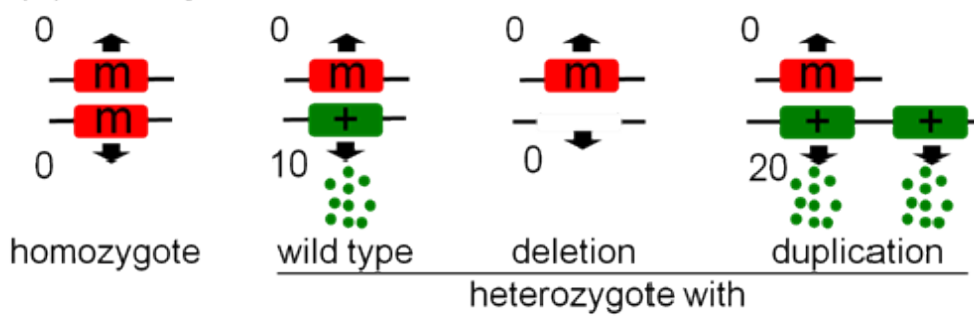

(c) Hypomorph – less than normal

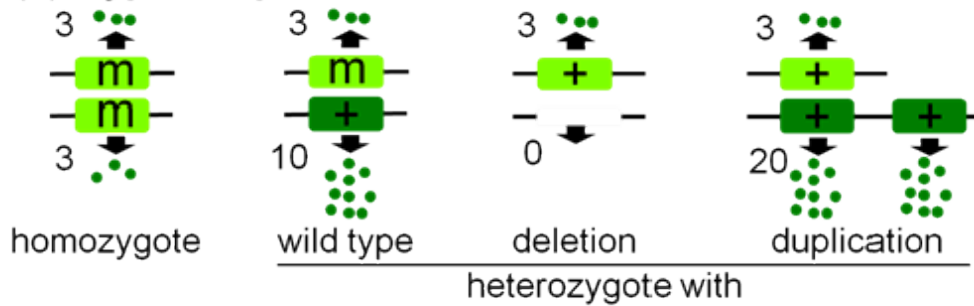

(d) Hypermorph – more than normal

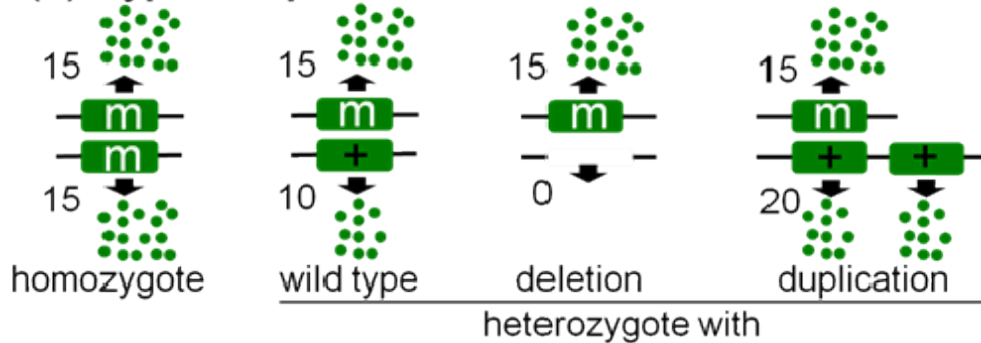

(e) Neomorph – new, different function



Figure 6.8.1 (a-f) Five Classes of Mutants Designated as Morphs (Forms) by a Nobel Prize Winner, H.J. Muller, Known as Muller's Morphs. [[Long description](#)]

Loss-of-Function

- Haplo-insufficient – a loss-of-function dominant mutation
- Null mutations – loss-of-function mutation that remove the activity of the gene product
- Hypomorphic mutations – decreased activity of the gene product – loss-of-function mutant phenotypes can be due to partial or complete elimination of the activity of a gene's encoded product

Gain-of-function

- Hypermorph – mutation that produces more gene activity per gene dose than wild-type
- Neomorph – mutation that produces some novel gene activity that is not characteristic of the wild-type

Media Attributions

- **Figure 6.8.1** [Original](#) by Locke (2017), [CC BY-NC 3.0](#), Open Genetics Lectures

References

Locke, J. (2017). Figure 7. Five classes of mutants designated as morphs [5 digital images]. In Locke, J., Harrington, M., Canham, L. and Min Ku Kang (Eds.), *Open Genetics Lectures, Fall 2017* (Chapter 13, p. 8). Dataverse/ BCcampus. http://solr.bccampus.ca:8001/bcc/file/7a7b00f9-fb56-4c49-81a9-cfa3ad80e6d8/1/OpenGeneticsLectures_Fall2017.pdf

Long Description

- **Figure 6.8.1** (a-f) Comparison of the wild type expresses normal function with the five types of mutants known as Muller's Morphs. The Amorph shows a loss of all function; the hypomorph shows less than normal function; the hypermorph shows more than normal function; the neomorph shows a new different function, and the antimorph produces a product which works against normal function. [Back to [Figure 6.8.1](#)]

Chapter 6 Summary

The topics covered in this chapter can be summarized as follows:

- Symbols are used to denote the alleles, or genotype, of a locus.
- Phenotype depends on the alleles that are present, their dominance relationships, and sometimes also interactions with the environment and other factors.
- A somatic mutation affects the individual but not the progeny, whereas a germline mutation affects the progeny in the next generation but not the individual in which they occur.
- In a diploid organism, alleles can be homozygous, heterozygous, or hemizygous.
- Allelic interactions at a locus can be described as dominant vs. recessive, incomplete dominance, or co-dominance.
- Muller's morphs classify all types of mutations including: amorph, hypomorph, hypermorph, neomorph, and antimorph.

Key Terms in Chapter 6

Key Terms – Alleles at a Single Locus

- ABO blood group
- amorph
- co-dominance
- complete dominance
- dominant
- gain-of-function
- genotype
- haploinsufficiency
- haplosufficiency
- hemizygous
- heterozygous
- homozygous
- hypermorph
- hypomorph
- incomplete (semi) dominance
- locus
- loss-of-function
- neomorph
- null
- phenotype
- recessive
- variant
- wild-type

Chapter 6 Study Questions

1. Distinguish among the following terms: (1) gene, (2) locus, (3) allele, (4) transcription unit.
2. A flower geneticist crosses a red flowered diploid plant with a white flower diploid plant and all the progeny are red. Use two different forms of symbols to show this cross and its progeny. What if all the progeny were pink?
3. If your blood type is B, what are the possible genotypes of your parents at the locus that controls the ABO blood types?
4. In the table below, match the mouse hair colour phenotypes with the term from the list that best explains the observed phenotype, given the genotypes shown. In this case, the allele symbols do not imply anything about the dominance relationships between the alleles.

List of terms: haplo-sufficiency, haplo-insufficiency, pleiotropy, incomplete dominance, co-dominance, incomplete penetrance, broad (variable) expressivity.

Case	A1A1	A1A2	A2A2
1	all hairs black	on the same individual: 50% of hairs are all black and 50% of hairs are all white	all hairs white
2	all hairs black	all hairs are the same shade of grey	all hairs white
3	all hairs black	all hairs black	50% of individuals have all white hairs and 50% of individuals have all black hairs
4	all hairs black	all hairs black	mice have no hair
5	all hairs black	all hairs white	all hairs white
6	all hairs black	all hairs black	all hairs white
7	all hairs black	all hairs black	hairs are a wide range of shades of grey

5. In this hypothetical example of *Drosophila* bristle mutations, when various, true-breeding mutant strains (all at a single locus) are crossed to a wild type strain the following phenotypes are observed in the progeny:
 - Mutant#1 = bristles 20% shorter
 - Mutant#2 = bristles 30% longer
 - Mutant#3 = bristles 50% shorter
 - Mutant#4 = bristles kinked and misshapen
 - Mutant#5 = bristles are missing

What is the best characterization, using Muller's Morphs, for each?

Chapter 6 Answers

1. These are four common terms that are often used interchangeably by novice students, but do have distinctly different meanings and uses.
 - i. gene = general term for a segment of nucleic acid that is responsible for one or more phenotypes
 - ii. locus = the position of a gene along a chromosome,
 - iii. allele = the form (DNA sequence) of a gene at a locus,
 - iv. transcription unit = the segment of DNA that is transcribed into RNA (often mRNA in the case of a protein coding gene).
2. Form (1) RR (red) x rr (white) gives Rr (red progeny). "R" is dominant to "r". Form (2) r+r+ (red) x r-r- (white) gives r+r- (red progeny). "r+" is dominant to "r-". For pink progeny, the symbols are the same, only "R" or "r+" is semi-dominant to "r" or "r-".
3. If your blood type is B, then your genotype is either $I^B i$ or $I^B I^B$. If your genotype is $I^B i$, then your parents could be any combination of genotypes, as long as one parent had at least one i allele, and the other parent had at least one I^B . If your genotype was $I^B I^B$, then both parents would have to have at least one I^B allele.
4. case 1 co-dominance; case 2 incomplete-dominance; case 3 incomplete penetrance; case 4 pleiotropy; case 5 haplo-sufficiency; case 6 haplo-insufficiency; case 7 broad (variable) expressivity
5.
 - Mutant#1 = hypomorph;
 - Mutant#2 = hypermorph;
 - Mutant#3 = amorph;
 - Mutant#4 = neomorph;
 - Mutant#5 = antimorph

CHAPTER 7 - THE CENTRAL DOGMA - MUTATIONS AND BIOCHEMICAL PATHWAYS

7.1 Introduction

Learning Objectives

- Discuss what is meant by “The Central Dogma” of Biology.
- Describe the Beadle and Tatum experiments which led to the “One gene, One enzyme” hypothesis.
- Outline the use of genetic screens for mutations and applications to biochemical pathway analysis.

How is the genetic information in DNA (genes) expressed as biological traits, such as the flower colour of Mendel's peas? The answer lies in what has become known as molecular biology's **Central Dogma**. While not all genes code for proteins, most do (**Figure 7.1.1**). This chapter describes the Central Dogma and some experiments that were used to support this concept.

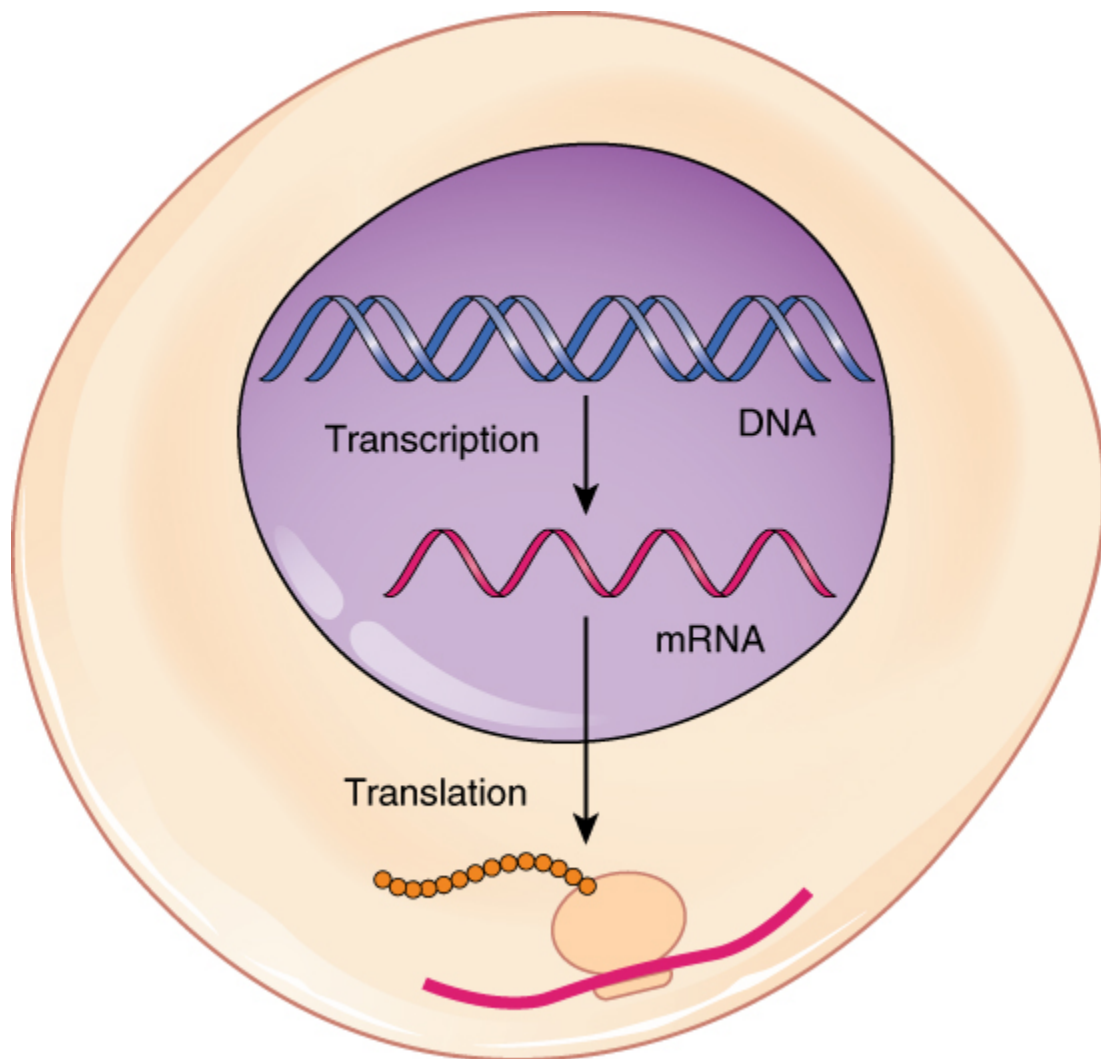

Figure 7.1.1 Most Genes Code for Proteins – But Not All. They are transcribed into mRNA, which is then translated into polypeptides. [[Long description](#)]

When we think of the word “mutation”, we automatically think of it as something negative or detrimental. However, a mutation, which is a change in the DNA sequence, may have one or more effects on an organism, depending on what it is and in which gene it occurs. While detrimental effects are most common, sometimes mutations can create new features. These mutations give us a tool with which to investigate the gene and the biological processes in which it is involved.

We will first take a look at how scientists perform genetic screening for mutations, and the various consequences of those mutations.



Figure 7.1.2 The Canadian Sphynx Lacks Hair Due to a Genetic Mutation. This breed originated in Minnesota, but the Canadian Sphynx line was started in Toronto in 1966 through a selective breeding program from a spontaneous mutation that gave naked kittens. This mutation is inherited in an autosomal recessive manner for the hairlessness gene. [[Long description](#)]

The Central Dogma of Biology describes the concept that genetic information is encoded in DNA in the form of genes (**Figure 7.1.3**). This information is then transferred as needed, in a process called **transcription** into a messenger RNA (mRNA) sequence. The information is then transferred again, in a process called **translation** into a polypeptide (protein) sequence. The sequence of bases in DNA directly dictates the sequence of bases in the RNA, which in turn dictates the sequence of amino acids that make up a polypeptide.

The original core of the Central Dogma is that genetic information is NEVER transferred from protein back to nucleic acids. In certain circumstances, the information in RNA may be converted back to DNA through a process called **reverse transcription**. As well, DNA, and its information, can also be replicated.

Proteins do most of the “work” in a cell. They (1) catalyze the formation and breakdown of most molecules within an organism, as well as (2) form their structural components, and (3) regulate the expression of genes. By dictating the sequence and thus structure of each protein, DNA directs the function of that protein, which can thereby, affect the

entire organism. Thus, the genetic information, or **genotype**, defines the potential form, or **phenotype** of the organism. Note, however, that the environment can also influence phenotype.

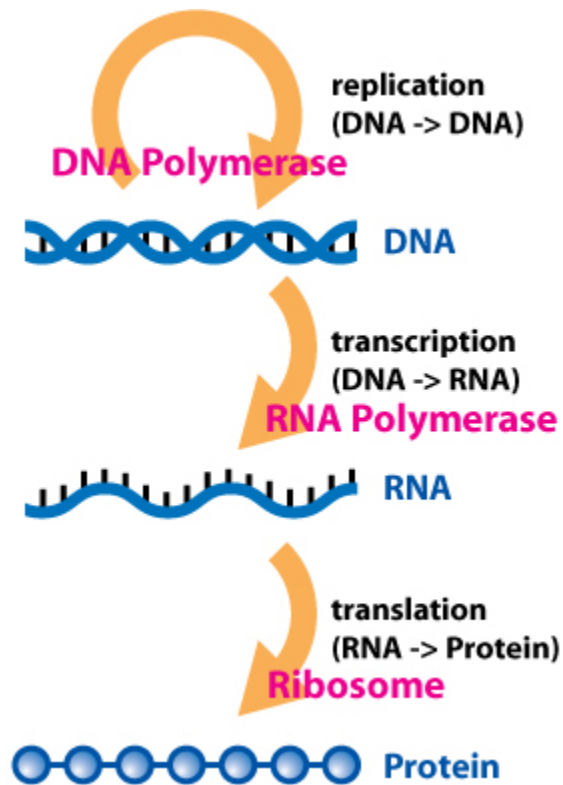
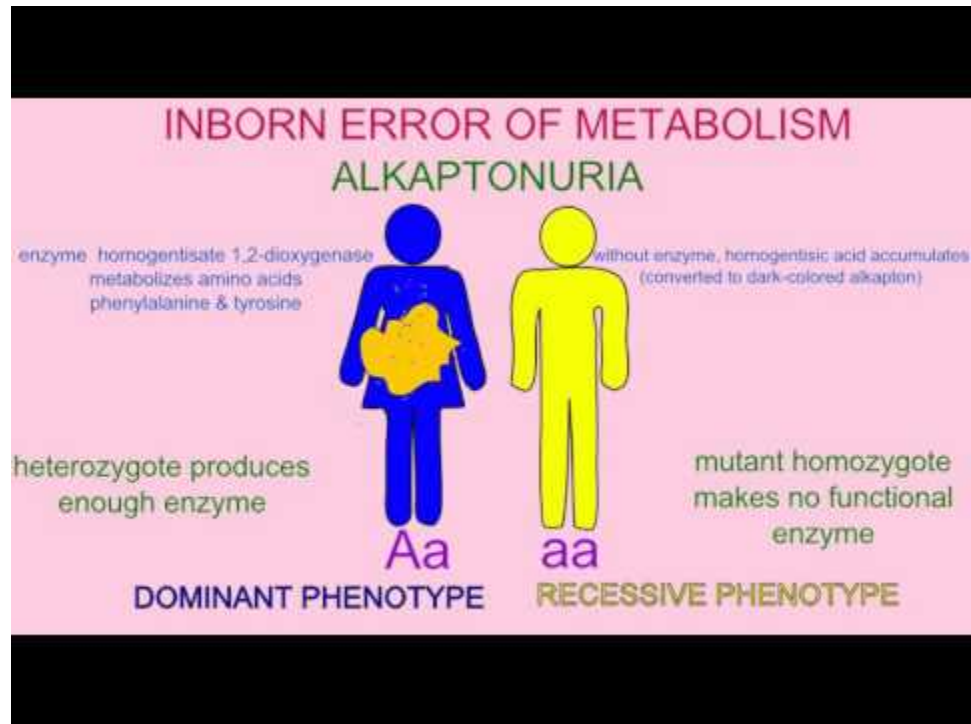

Figure 7.1.3 Central Dogma of Molecular Biology. [[Long description](#)]

In the case of Mendel's peas, purple-flowered plants have a gene that encodes an enzyme that produces a purple pigment molecule. In the white-flowered plants (a pigment-less mutant), the DNA for this gene has been changed, or mutated, so that it no longer encodes a functional protein. This is an example of a spontaneous, natural mutation in a gene coding for an enzyme in a biochemical pathway.

Life depends on (bio)chemistry to supply energy and to produce the molecules that construct and regulate cells. In 1908, Archibald Garrod described "in-born errors of metabolism" in humans using the congenital disorder, alkaptonuria (black urine disease), as an example of how "genetic defects" (genotype) led to the lack of an enzyme in a biochemical pathway and caused a disease (phenotype). The reason why people with alkaptonuria have black urine is because a chemical, called "alkapton", makes urine black when exposed to air. In normal people, enzymes catalyze the reaction to break down alkapton, but people who are born with the disease, due to genetic defect, cannot make such enzymes and, therefore, cannot break down alkapton. Garrod's work gave huge impact to modern genetics as it attempted to explain the biochemical mechanism behind the genes proposed in Mendelian genetics.

Take a look at the video below, *Inborn Error of Metabolism: Alkaptonuria*, by Walter Jahn (2016) on YouTube, which describes alkaptonuria.



A YouTube element has been excluded from this version of the text. You can view it online here:

<https://opengenetics.pressbooks.tru.ca/?p=740>

Media Attributions

- **Figure 7.1.1** [0328 Transcription-translation Summary](#) from Betts et al. (2013), [OpenStax](#), [CC BY 4.0](#), via Wikimedia Commons
- **Figure 7.1.2** [Canadian Sphynx Red](#) by Tgianf75, [CC BY-SA 3.0](#), via Wikimedia Commons
- **Figure 7.1.3** [Central Dogma of Molecular Biochemistry with Enzymes](#) by Daniel Horspool [[Dhorspool](#)] at en.wikipedia, [CC BY-SA 3.0](#), via Wikimedia Commons

References

Betts et al. (2013, April 25). Figure 3.29 From DNA to Protein: Transcription through Translation [digital image]. In *Anatomy and Physiology*. OpenStax. <https://openstax.org/books/anatomy-and-physiology/pages/3-4-protein-synthesis>

Jahn, W. (2016, July 16). Inborn error of metabolism: Alkaptonuria (video file). YouTube. <https://www.youtube.com/watch?v=T6QDc7TCrv4>

Long Descriptions

- **Figure 7.1.1** The central dogma of molecular biology is represented by a cell which contains the nucleus, where transcription of DNA is facilitated to produce mRNA, which is then transported out of the nucleus into the cytoplasm, where translation on the ribosome then takes place, which produces proteins. [Back to [Figure 7.1.1](#)]
- **Figure 7.1.2** The Canadian Sphynx Lack Hair Due to a Genetic Mutation. This breed originated in Minnesota, but the Canadian Sphynx line was started in Toronto in 1966 through a selective breeding program from a spontaneous mutation that gave naked kittens. This mutation is inherited in an autosomal recessive manner for the hairlessness gene. [Back to [Figure 7.1.2](#)]
- **Figure 7.1.3** The central dogma of molecular biology is shown to be represented by first, replication of DNA before cell division, then secondly, transcription of DNA is facilitated to produce mRNA, followed finally by translation on the ribosome to produce polypeptides. [Back to [Figure 7.1.3](#)]

7.2 The Beadle and Tatum Experiments

In 1941, over 30 years after Garrod's discovery, **Beadle and Tatum** built on this connection between genes and **metabolic pathways**. Their research led to the “**one gene, one enzyme (or protein)**” hypothesis, which states that each enzyme that acts in a biochemical pathway is encoded by a different gene. Although we now know of many exceptions to the “one gene, one enzyme” principle, it is generally true that each gene produces a protein with a distinct catalytic, regulatory, or structural function.

Beadle and Tatum used the fungus ***Neurospora crassa*** (a bread mould) for their studies, because it had practical advantages as a laboratory model organism. They knew that *Neurospora* was **prototrophic**, meaning it could grow on **minimal medium (MM)**. Minimal medium lacked most nutrients, except for a few minerals, simple sugars, and one vitamin (biotin). Prototrophs can synthesize the amino acids, vitamins, etc. necessary for normal growth.

They isolated a series of mutations known to interrupt the synthesis of arginine, an amino-acid necessary for mould growth. Their hypothesis stated that individual mutations inhibited discrete steps in the pathway used by the mould to synthesize arginine from precursors in their environmental medium.

The video below, *Beadle and Tatum Part 1: Neurospora crassa*, by SciencePrimer (2018) on YouTube, gives an introduction to haploid *Neurospora crassa* which Beadle and Tatum used in their experiments.

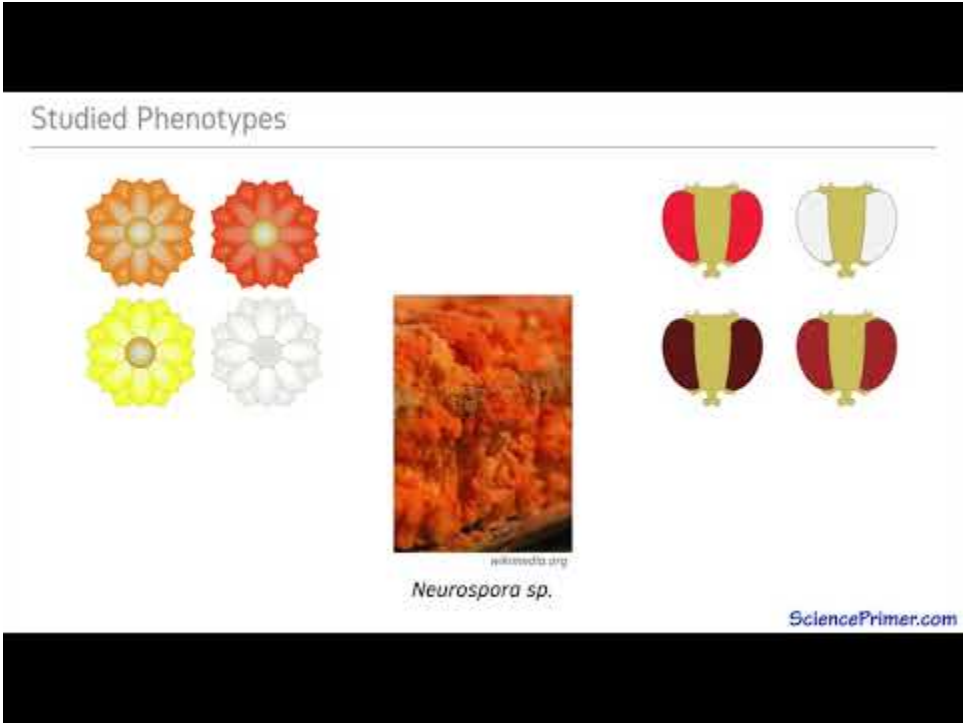

Studied Phenotypes

Neurospora sp.

SciencePrimer.com

A YouTube element has been excluded from this version of the text. You can view it online here:
<https://opengenetics.pressbooks.tru.ca/?p=761>

Note: You can watch [Beadle and Tatum Part 2: The Experiment](https://youtu.be/fXASTY-YoRQ), by SciencePrimer (2018) on YouTube (<https://youtu.be/fXASTY-YoRQ>).

They knew that by exposing *Neurospora* spores to X-rays, they could randomly induce mutations in genes (now known as damage to the DNA leading to DNA sequence change). Each spore exposed to X-rays potentially contained a mutation in a different gene. While most mutagenized spores were still able to grow (prototrophic), some spores had mutations that changed their phenotype from a prototroph into an **auxotrophic** strain, which could no longer grow on minimal medium. Instead these auxotrophs could grow on **complete medium (CM)**, which was MM supplemented with nutrients, such as amino acids and vitamins, etc. (**Figure 7.2.1**). In fact, some auxotrophic mutations could grow on minimal medium with only one, single nutrient supplied, such as the amino acid arginine. This implied that each auxotrophic mutant was blocked at a specific step in a biochemical pathway and that by adding an essential compound, such as arginine, that block could be circumvented. **Figure 7.2.2** gives the results of such experiments, demonstrating the survival (or not) of mutants, depending on the nutrients supplied, and the perturbation of the biochemical pathway involved, depending on the particular mutation.

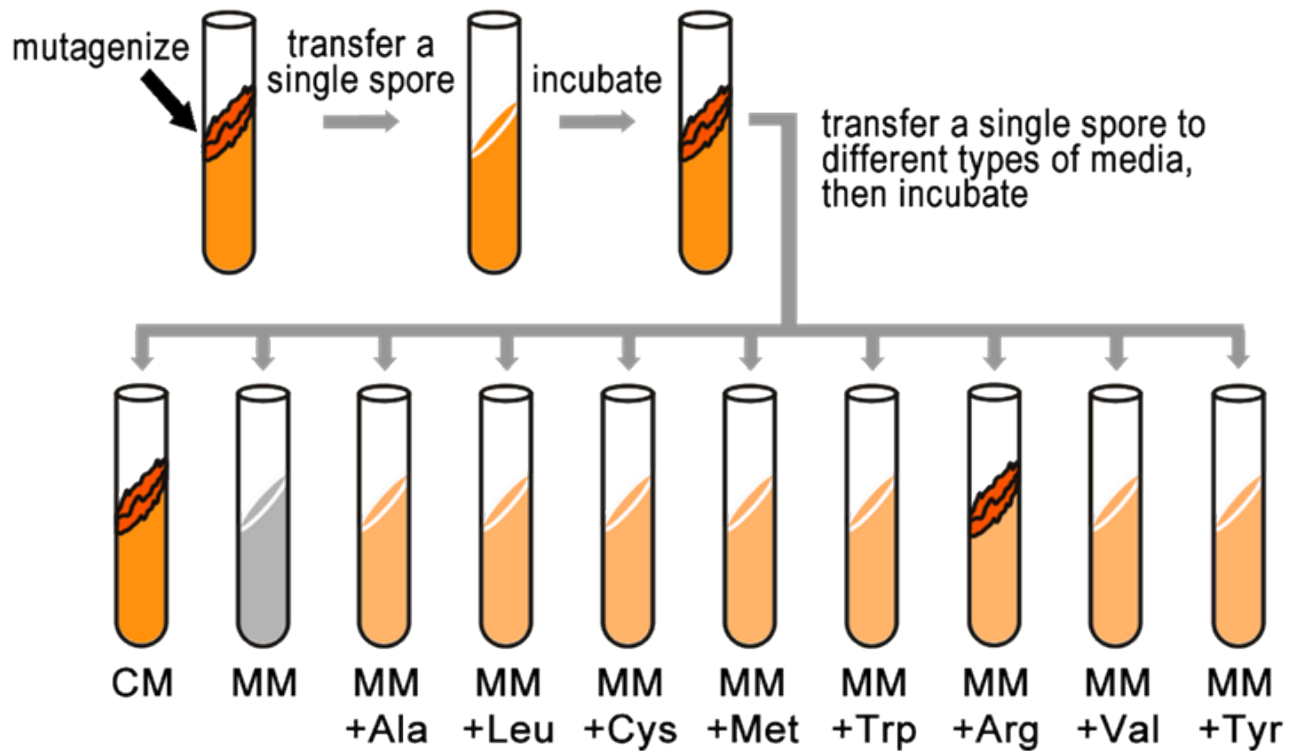
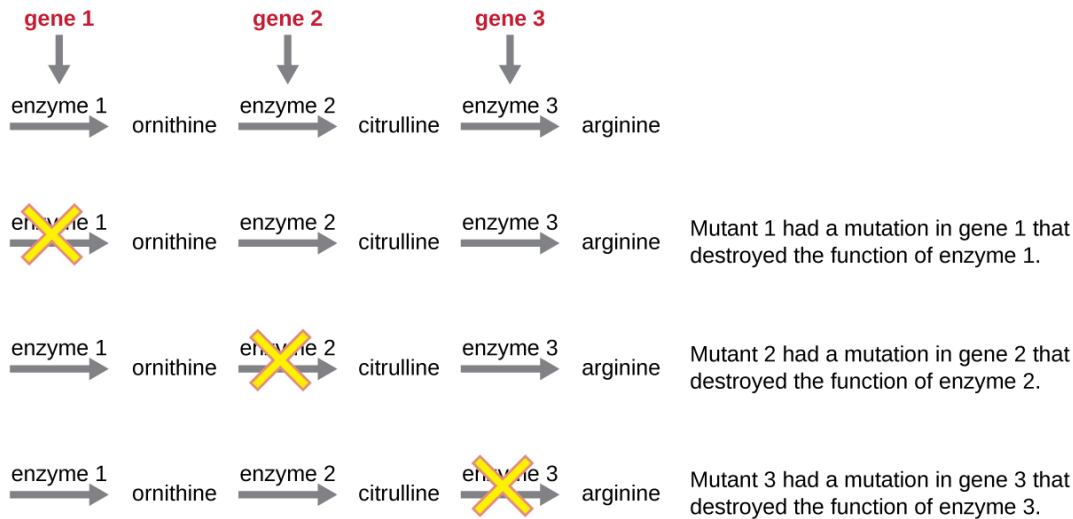

Figure 7.2.1 A Single Mutagenized Spore is Used to Establish a Colony of Genetically Identical Fungi, from Which Spores are Tested for Their Ability to Grow on Different Types of Media. Because spores of this particular colony are able to grow only on complete medium (CM), or on minimal medium supplemented with arginine (MM+Arg), they are considered Arg auxotrophs and we infer that they have a mutation in a gene in the Arg biosynthetic pathway. This type of screen is repeated many times to identify other mutants in the Arg pathway and in other pathways. [[Long description](#)]

Beadle and Tatum Experiments				
Bread Mold	Minimal Medium (MM)	MM + Ornithine	MM + Citrulline	MM + Arginine
Wild type	grew	grew	grew	grew
Mutant 1	did not grow	grew	grew	grew
Mutant 2	did not grow	did not grow	grew	grew
Mutant 3	did not grow	did not grow	did not grow	grew

Figure 7.2.2 The Survival of Mutants Depends on the Nutrients Supplied, and the Perturbation of the Biochemical Pathway Involved Depends on the Particular Mutation [Long description]



Beadle and Tatum linked many nutritional mutants to specific amino acids and vitamin biochemical pathways. This work demonstrated that individual genes are connected to specific enzymes. This initial discovery which made the link between genes and enzymes (which garnered a Nobel prize) was called the “one gene–one enzyme” hypothesis, which we will look at in the next section.

Media Attributions

- **Figure 7.2.1** [Original](#) by Deyholos (2017), [CC BY-NC 3.0](#), Open Genetics Lectures
- **Figure 7.2.2** [OSC Microbio 10 01 GeneEnzyme](#) from Parker et al. (2016), [CNX OpenStax](#), [CC BY 4.0](#), via Wikimedia Commons

References

Deyholos, M. (2017). Figure 3. A single mutagenized spore...[digital image]. In Locke, J., Harrington, M., Canham, L. and Min Ku Kang (Eds.), *Open Genetics Lectures, Fall 2017* (Chapter 3, p. 2). Dataverse/ BCcampus. http://solr.bccampus.ca:8001/bcc/file/7a7b00f9-fb56-4c49-81a9-cfa3ad80e6d8/1/OpenGeneticsLectures_Fall2017.pdf

Parker, N., Schneegurt, M., Thi Tu, A-H., Lister, P., Forster, B. M. (2016, November 1). Figure 10.6 Three classes of arginine mutants were identified...[digital image]. In *Microbiology*. OpenStax. <https://openstax.org/books/microbiology/pages/10-1-using-microbiology-to-discover-the-secrets-of-life>

SciencePrimer. (2018, December 18). Beadle and Tatum Part 1: Neurospora crassa (video file). YouTube. https://www.youtube.com/watch?v=cETqxsB_Bw

SciencePrimer. (2018, December 22). Beadle and Tatum Part 2: The Experiment (video file). YouTube. <https://www.youtube.com/watch?v=fXASTY-YoRQ>

Long Descriptions

- **Figure 7.2.1** A single mutagenized spore is used to establish a colony of genetically identical fungi, from which spores are tested for their ability to grow on different types of media. Because spores of this particular colony can only grow on complete medium (CM), or on minimal medium supplemented with arginine (MM+Arg), they are considered Arg auxotrophs, and we infer that they have a mutation in a gene in the Arg biosynthetic pathway. This type of screen is repeated many times to identify other mutants in the Arg pathway and in other pathways. [Back to [Figure 7.2.1](#)]
- **Figure 7.2.2** Beadle and Tatum experimental set up which shows the wild type alongside various mutants and their ability to grow or not on either minimal media or minimal media supplemented with various nutrients such as ornithine, citrulline and arginine. Depending on whether the mutant grew or not, biochemical pathways are postulated, whereby the mutant lacks a specific enzyme, which is part of the series required to convert a precursor into arginine, which is the final product of the pathway. [Back to [Figure 7.2.2](#)]

7.3 The "One Gene: One Enzyme" Hypothesis

Beadle and Tatum's experiments are important not only for their conceptual advances in understanding genes, but also because they demonstrate the utility of **screening for genetic mutants** to investigate a biological process – this is called **genetic analysis**.

Beadle and Tatum's results were useful to investigate biological processes, specifically the metabolic pathways that produce amino acids. For example, Srb and Horowitz (1944) tested the ability of the amino acids to **rescue** auxotrophic strains. They added one of each of the amino acids to minimal medium and recorded which of these restored growth to independent mutants.

Watch the video below, *BIOL 183: Beadle & Tatum's One-Gene-One-Enzyme hypothesis*, by Susan Bush (2020) at Metropolitan State University on YouTube, which explains the one – gene – one – enzyme hypothesis.

Beadle & Tatum's One Gene, One Enzyme hypothesis

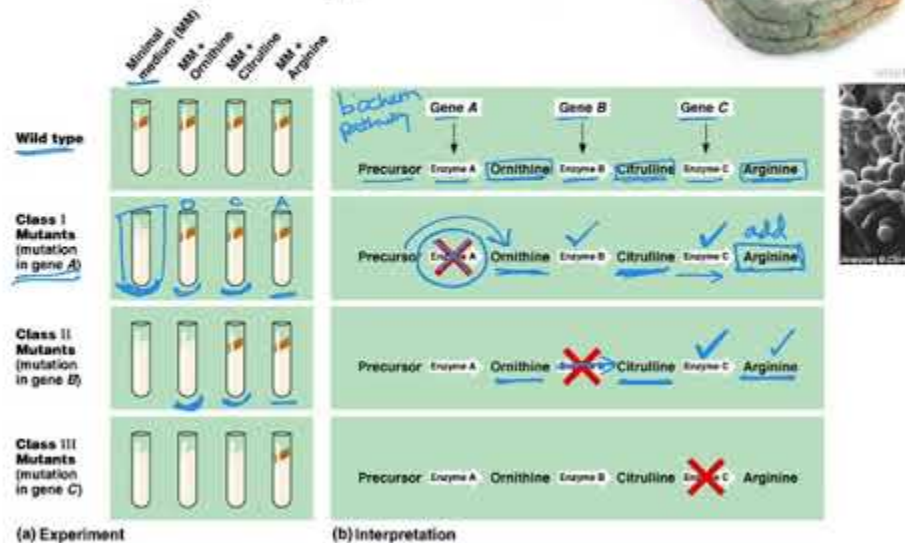

A YouTube element has been excluded from this version of the text. You can view it online here:

<https://opengenetics.pressbooks.tru.ca/?p=771>

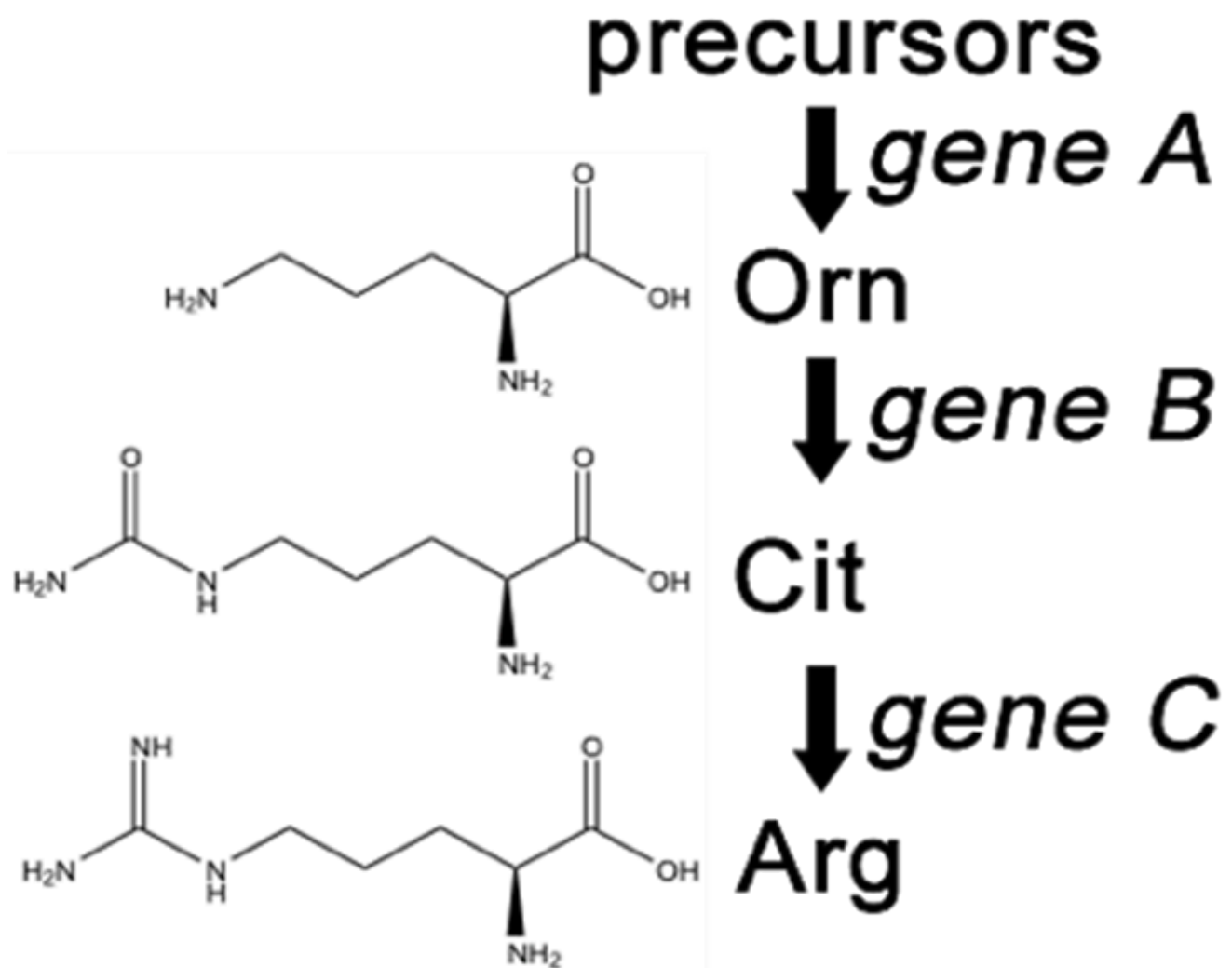

Figure 7.3.1 A Simplified Version of the Arg Biosynthetic Pathway, Showing Citrulline (Cit) and Ornithine (Orn) as Intermediates in Arg Metabolism. These chemical reactions depend on enzymes represented here as the products of three different genes. [[Long description](#)]

A convenient example is arginine. If the progeny of a mutagenized spore could grow on minimal medium only when it was supplemented with **arginine (Arg)**, then the auxotroph must bear a mutation in the Arg biosynthetic pathway and was called an “arginineless” strain (arg⁻).

Synthesis of even a relatively simple molecule, such as arginine, requires many steps – each with a different enzyme. Each enzyme works sequentially on a different intermediate in the pathway (**Figure 7.3.1**). For arginine (Arg), two biochemical intermediates are ornithine (Orn) and citrulline (Cit). Thus, mutation of any one of the enzymes in this pathway could turn *Neurospora* into an Arg auxotroph (arg⁻). Srb and Horowitz extended their analysis of Arg auxotrophs by testing the intermediates of amino acid biosynthesis for the ability to restore growth of the mutants (**Figure 7.3.2**).

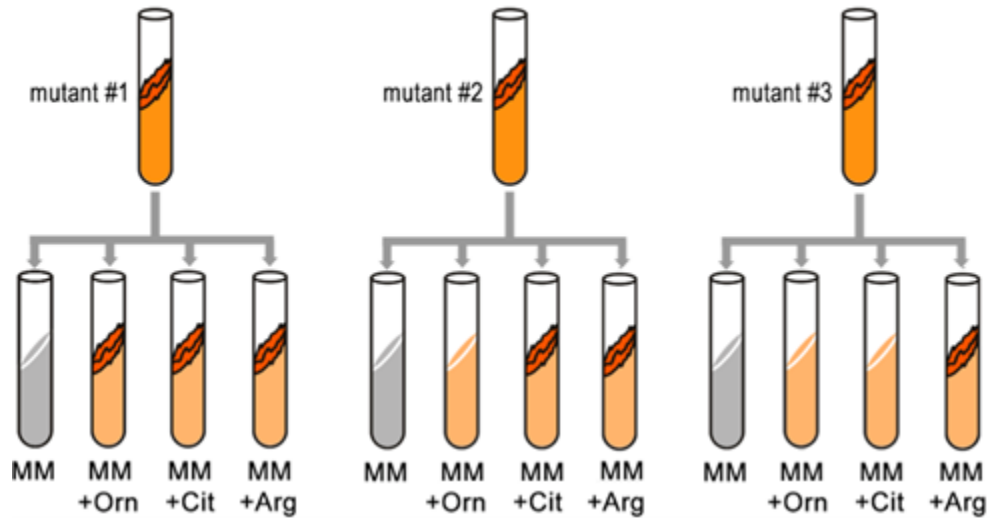

Figure 7.3.2 Testing Different Arg Auxotrophs for Their Ability to Grow on Media Supplemented with Intermediates in the Arg Biosynthetic Pathway [[Long description](#)]

They found that only Arg could rescue all the Arg auxotrophs, while either Arg or Cit could rescue some (**Table 7.3.1**). Based on these results, they deduced the location of each mutation in the Arg biochemical pathway (i.e., which gene was responsible for the metabolism of which intermediate).

Table 7.3.1 Ability of auxotrophic mutants of each of the three enzymes of the Arg biosynthetic pathways to grow on minimal medium (MM) supplemented with Arg or either of its precursors, Orn and Cit. Gene names refer to the labels used in Figure 7.3.1.

Mutants In	MM + Orn	MM + Cit	MM + Arg
gene A	Yes	Yes	Yes
gene B	No	Yes	Yes
gene C	No	No	Yes

The video below, *Gene Interactions P1*, by Michelle Stieber (2014) on YouTube, discusses gene interactions and related biochemical pathways.

Growth of *arg* Mutants in Response to Supplements

Table 6-1 Growth of *arg* Mutants in Response to Supplements

Mutant	Supplement		
	Ornithine	Citrulline	Arginine
<i>arg-1</i>	+	+	+
<i>arg-2</i>	-	+	+
<i>arg-3</i>	-	-	+



A YouTube element has been excluded from this version of the text. You can view it online here:

<https://opengenetics.pressbooks.tru.ca/?p=771>

Media Attributions

- **Figure 7.3.1** [Original](#) by Deyholos (2017), [CC BY-NC 3.0](#), Open Genetics Lectures
- **Figure 7.3.2** [Original](#) by Deyholos (2017), [CC BY-NC 3.0](#), Open Genetics Lectures

References

Bush, S. (2020, April 16). BIOL 183: Beadle & Tatum's one-gene-one-enzyme hypothesis (video file). YouTube.

<https://www.youtube.com/watch?v=4nXX2djQVvI>

Deyholos, M. (2017). Figures: 4. A simplified version of the Arg biosynthetic pathway... and 5. Testing different Arg auxotrophs for their ability to grow...(digital image). In Locke, J., Harrington, M., Canham, L. and Min Ku Kang (Eds.), *Open Genetics Lectures, Fall 2017* (Chapter 3, p. 3). Dataverse/ BCcampus. http://solr.bccampus.ca:8001/bcc/file/7a7b00f9-fb56-4c49-81a9-cfa3ad80e6d8/1/OpenGeneticsLectures_Fall2017.pdf

Srb, A. M. & Horowitz N. H. (1944). The ornithine cycle in *Neurospora* and its genetic control. *Journal of Biological Chemistry*, 154, 129-139. [https://doi.org/10.1016/S0021-9258\(18\)71951-0](https://doi.org/10.1016/S0021-9258(18)71951-0)

Stieber, M. (2014, April 12). Gene interactions P1 (video file). YouTube. <https://www.youtube.com/watch?v=Fv7UtsPFF-A>

Long Descriptions

- **Figure 7.3.1** The arginine biosynthetic pathway, showing the organic structures of citrulline and ornithine as intermediates in arginine metabolism. These chemical reactions depend on enzymes, which are the products of three different genes: A, B and C. [Back to [Figure 7.3.1](#)]
- **Figure 7.3.2** Three mutants are tested for their ability to grow on minimal media, or minimal media supplemented with ornithine, citrulline, or arginine. Depending on the gene that is not functional in the particular mutant, they may or may not thrive in various media, therefore only arginine could rescue all the arginine auxotrophs, while either ornithine or citrulline could rescue others. [Back to [Figure 7.3.2](#)]

7.4 Genetic Screening and Biochemical Pathways

Using many other mutations and the “one gene: one enzyme model” permits the genetic dissection of many other biochemical and developmental pathways. The general strategy for a **genetic screen for mutations** is to expose a population to a mutagen, then look for individuals among the progeny with defects in the biological process of interest. There are many details that must be considered when designing a genetic screen (e.g., how can recessive alleles be made homozygous). Nevertheless, mutational analysis has been an extremely powerful and efficient tool in identifying and characterizing the genes involved in a wide variety of biological processes, including many genetic diseases in humans.

The video, *Genetic Screen*, by Animated biology with arpan (2017) on YouTube, discusses the methods used to perform genetic screening.

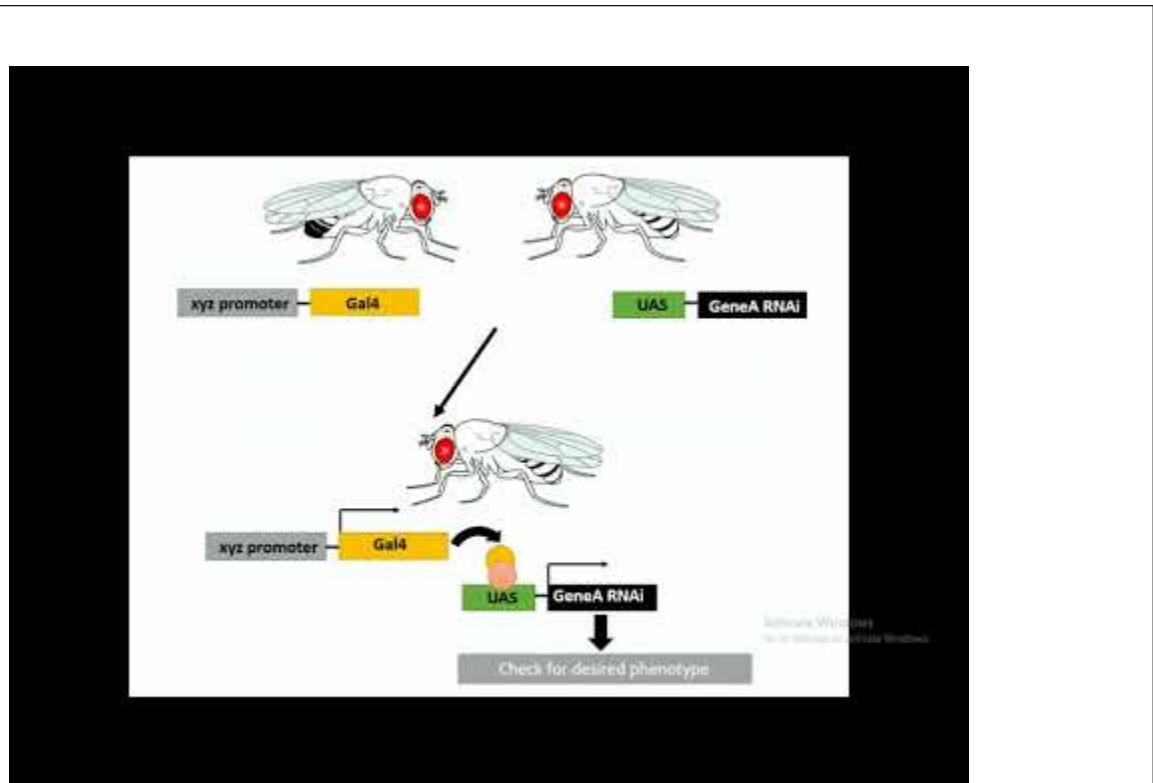

A YouTube element has been excluded from this version of the text. You can view it online here:

<https://opengenetics.pressbooks.tru.ca/?p=779>

Forward genetic screening refers to the process of finding the gene or genes responsible for a certain phenotype or biochemical process. One way to identify genes that affect a particular biological process is to induce random mutations in a large population, and then look for mutants with phenotypes that might be caused by a disruption of a particular biochemical pathway. This is the strategy of **mutant screening**, which is used effectively to identify and understand the molecular components of hundreds of different biological processes. To find the basic biological processes of memory and learning, researchers have screened mutagenized populations of *Drosophila* to recover flies (or larvae) that lack the normal ability to learn (yes, *Drosophila* can learn). Mutants lack the ability to associate a particular odor with an electric shock. Because of the similarity of biology among all organisms (common descent), some genes identified by this

mutant screen of a model organism may be relevant to learning and memory in humans, including conditions such as Alzheimer's disease.

On the other hand, **reverse genetic screening** refers to the process of creating a mutation in a gene, then identifying the phenotypic consequences of that specific mutant gene on the organism. This method is becoming more useful with the advent of whole genome sequencing. Here, we have identified the gene sequences, but are unsure of what each gene does.

Genetic Screens

In a typical mutant screen, researchers treat a parental population with a mutagen. This may involve soaking seeds in EMS, or mixing a mutagen with the food fed to flies. Usually, no phenotypes are visible among the individuals directly exposed to the mutagen, because in all the cells, every strand of DNA will be affected independently. Thus, the induced mutations will be heterozygous and limited to single cells.

However, what is most important to geneticists are the mutations in the germline of the mutagenized individuals. The **germline** is defined as the gametes and any of their developmental precursors, and is therefore distinct from the **somatic cells** (i.e., non-reproductive cells) of the body. Because most induced mutations are recessive, the progeny of mutagenized individuals must be mated in a way that allows the newly induced mutations to become homozygous (or hemizygous). Strategies for doing this vary between organisms. In any case, the generation in which induced mutations are expected to show a phenotype can be examined for the presence of novel traits. Once a relevant mutant has been identified, geneticists can begin to make inferences about the normal function of the mutated gene, based on its mutant phenotype. This can be further investigated, with molecular genetic techniques, to connect the gene function with the external appearance.

The video, *Genetic Systems for Detecting Mutation*, by Alex Nieves (2020) on YouTube, discusses the Genetic Systems used to detect mutations.

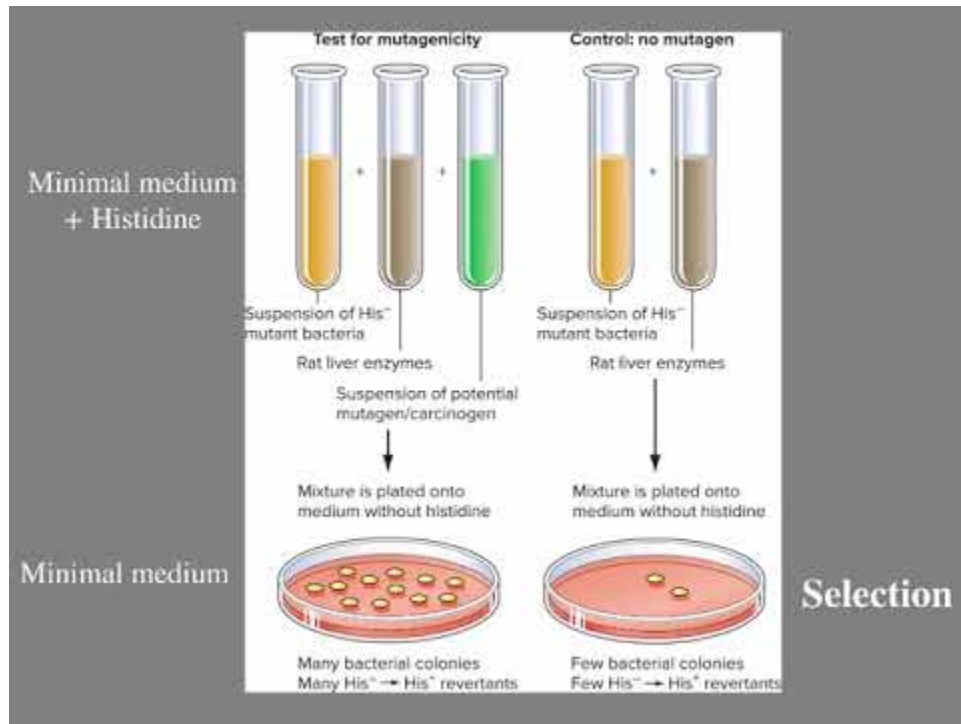

A YouTube element has been excluded from this version of the text. You can view it online here:

<https://opengenetics.pressbooks.tru.ca/?p=779>

References

Animated biology With arpan (2017, October 24). Genetic screen (video file). YouTube. <https://www.youtube.com/watch?v=q6JrUrrH8e8>

Nieves, A. (2020, April 27). Genetic systems for detecting mutation (video file). YouTube. <https://www.youtube.com/watch?v=AM60LcYHrcQ>

7.5 Mutations Without Detectable Phenotypes

Not all DNA sequence changes result in mutant phenotypes – the various reasons are described below.

Silent Changes

After mutagen treatment, the vast majority of base pair changes (especially substitutions) have no obvious effect on the phenotype. Often, this is because the change occurs in the DNA sequence of a non-coding region of the DNA, such as in **intergenic regions** (between genes) or within an intron where the sequence does not code for protein and is not essential for proper mRNA splicing. Also, even if the change affects the coding region, it may not alter the amino acid sequence (recall that the genetic code is degenerate; for example, GCT, GCC, GCA, and GCG all encode alanine) and is referred to as a **silent** mutation. Additionally, the base substitution may change an amino acid, but this does not quantitatively or qualitatively alter the function of the product, so no phenotypic change would occur.

Watch the video, *Silent (Synonymous) Mutations of a Gene Explained*, by Nikolay's Genetics Lessons (2020) on YouTube, which further discusses silent gene mutations.

Within the coding region of a gene, where would you most likely find silent polymorphisms?

ATC AAA TCC CAA TTG AGG

		Second letter				
		U	C	A	G	
First letter	U	UUU } Phe UUC } UUA } Leu UUG }	UCU } UCC } Ser UCA } UCG }	UAU } Tyr UAC } UAA } Stop UAG } Stop	UGU } Cys UGC } UGA } Trp UGG } Trp	U C A G
	C	CUU } CUC } Leu CUA } CUG }	CCU } CCC } Pro CCA } CCG }	CAU } His CAC } CAA } Gln CAG }	CGU } CGC } Arg CGA } CGG }	U C A G
	A	AUU } Ile AUC } AUA } Met AUG }	ACU } ACC } Thr ACA } ACG }	AAU } Asn AAC } AAA } Lys AAG }	AGU } Ser AGC } AGA } Stop AGG } Stop	U C A G
	G	GUU } GUC } Val GUA } GUG }	GCU } GCC } Ala GCA } GCG }	GAU } Asp GAC } GAA } Glu GAG }	GGU } GGC } Gly GGA } GGG }	U C A G

A YouTube element has been excluded from this version of the text. You can view it online here:

<https://open.genetics.pressbooks.tru.ca/?p=805>

Environment and Genetic Redundancy

There are situations where a mutation can cause a complete loss-of-function of a gene, yet not produce a change in the phenotype, even when the mutant allele is homozygous. The lack of a visible phenotypic change can be due to **environmental effects**: the loss of that gene product may not be apparent in that specific environment, but might be in another. An example, is an auxotrophic mutant on complete medium. Conversely, researchers can alter the environment to reveal such mutants (e.g., auxotrophs on minimal media).

Alternatively, the lack of a phenotype might be attributed to genetic **redundancy**. That is, the mutant gene's lost function is compensated by another gene, at another locus, encoding a similarly functioning product. Thus, the loss of one gene is compensated by the presence of another. The concept of genetic redundancy is an important consideration in genetic screens. A gene whose function can be compensated for by another gene, cannot be easily identified in a genetic screen for loss of function mutations.

Essential Genes and Lethal Alleles

Some mutant may be required to reach a particular developmental stage before the phenotype can be seen or scored. For example, flower color can only be scored in plants that are mature enough to make flowers, and eye color can only be scored in flies that have developed to the adult stage. However, some mutant organisms may not develop sufficiently to reach a stage that can be scored for a particular phenotype. Mutations in **essential genes** create recessive lethal alleles that arrest or derail the development of an individual at an immature (embryonic, larval, or pupal) stage. This type of mutation may, therefore, go unnoticed in a typical mutant screen because they are absent from the progeny being screened. Furthermore, the progeny of a monohybrid cross involving an embryonic lethal recessive allele may all be of a single phenotypic class; giving a phenotypic ratio of 1:0 (which is the same as 3:0). In this case, the mutation may not be detected. Nevertheless, the study of recessive lethal mutations (those in essential genes) has elucidated many important biochemical pathways.

The identification of whole classes of genes involved in early embryonic development, is one example. Three *Drosophila* geneticists, [Eric Wieschaus](#), [Edward Lewis](#), and [Christiane Nüsslein-Volhard](#), who were awarded a *Nobel Prize in Physiology or Medicine* in 1995 (Nobel Prize Outreach, n.d.), identified pair-rule, gap, and segment polarity genes that have corresponding homologs in all segmented organisms, including humans.

Naming Genes

Many genes are first identified in mutant screens and, so, they tend to be named after their mutant phenotypes – not the normal function or phenotype. This can cause some confusion for students of genetics. For example, we have already encountered an X-linked gene named *white* in fruit flies. Null mutants of the *white* gene have white eyes, but the normal *white+* allele has red eyes. This tells us that the wild type (normal) function of this gene is required to make red eyes. We now know its product is a protein that imports a colourless pigment precursor into developing cells of the eye. Why don't we call it the "red" gene, since that is what its product does? Because there are more than one-dozen genes that, when mutant, alter the eye colour: *violet*, *cinnabar*, *brown*, *scarlet*, etc. For all of these genes, their function is also needed to make the eye wild-type red, and not the mutant colour. If we used the name "red" for all these genes,

it would be confusing. So we use the distinctive mutant phenotype as the gene name. However, this can be problematic, as with the “lethal” mutations described above. This problem is usually handled by giving numbers or locations to the gene name, or making up names that describe how they die (e.g., *even-skipped*, *hunchback*, *hairy*, *runt*, etc.).

Reference

Nikolay's Genetics Lessons. (2020, October 20). Silent (synonymous) mutations of a gene explained (video file). YouTube. <https://www.youtube.com/watch?v=H-B9KIkYldY>

Nobel Prize Outreach. (n.d.). *The nobel prize in physiology or medicine 1995*. NobelPrize.org. <https://www.nobelprize.org/prizes/medicine/1995/summary/>

7.6 Cystic Fibrosis in Humans

Cystic Fibrosis (CF) – Autosomal Recessive

Cystic fibrosis (CF) is one of many diseases that geneticists have shown to be primarily caused by mutation in a single, well-characterized gene. Cystic fibrosis is the most common ($\frac{1}{2,500}$) life-limiting autosomal recessive disease among people of European heritage, with ~ 1 in 25 people being carriers. The frequency varies in different populations. Most of the deaths caused by CF are the result of lung disease, but many CF patients also suffer from other disorders including infertility and gastrointestinal disease. The disease is due to a mutation in the **CFTR** (Cystic Fibrosis Transmembrane Conductance Regulator) gene, which was first identified by **Lap-chee Tsui's** group at the University of Toronto (Tsui, 1995). Lap-Chee Tsui was inducted into the Canadian Medical Hall of Fame in March 2012 and is still a leader in CF research (Canadian Medical Association, n.d.).

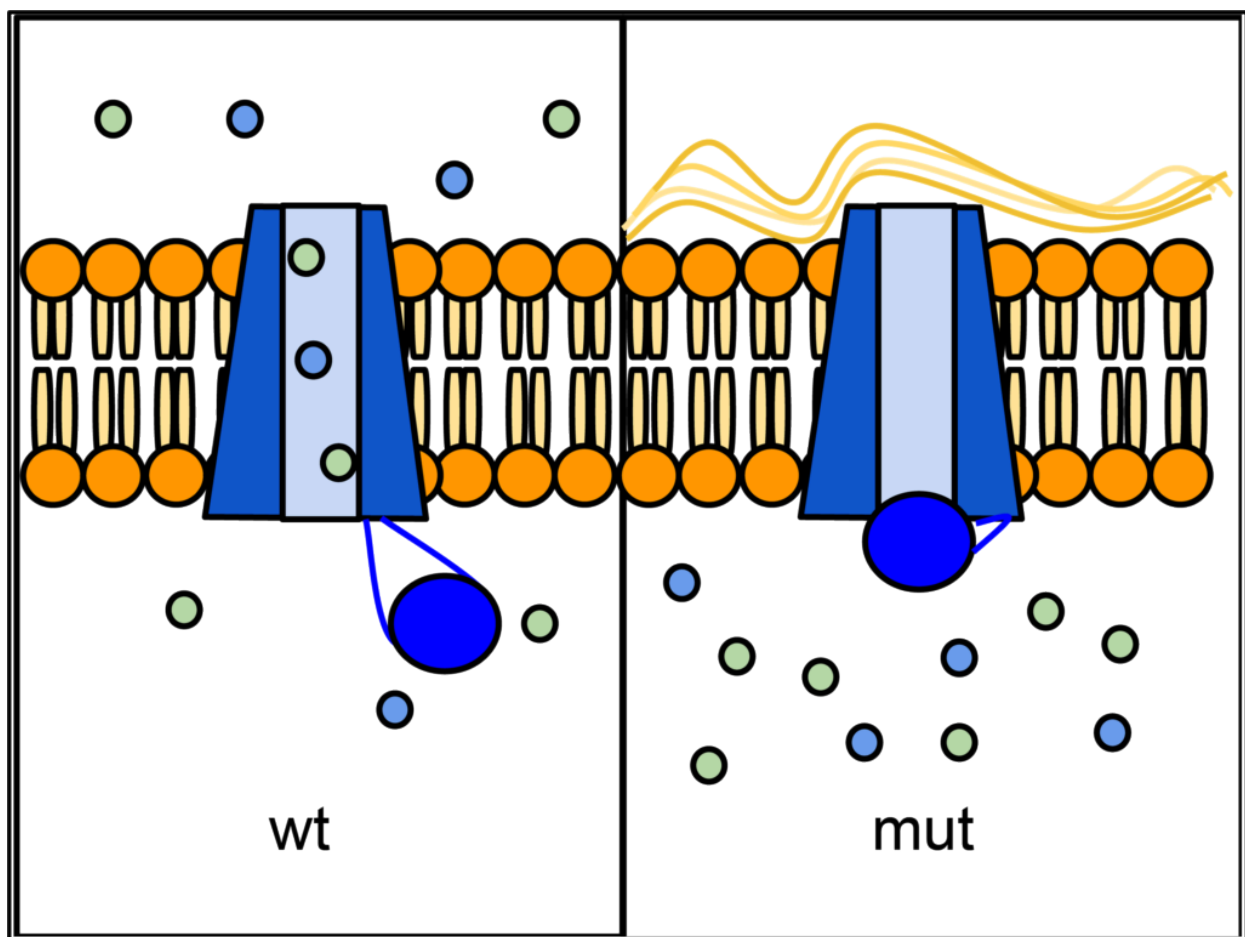
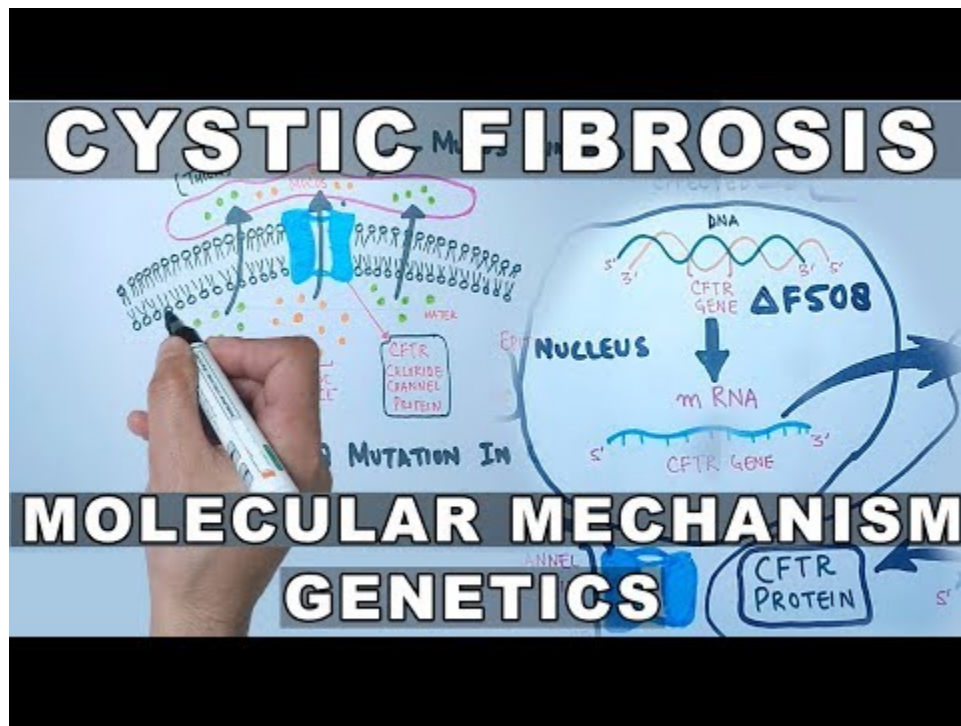

Figure 7.6.1 Wild-Type and Mutant Forms of CFTR in the Cell Membrane. In wild-type, the CFTR ion channel is gated. When activated by ATP, the channel opens and allows ions to move across the membrane. In some CFTR mutants, the channel does not open. This prevents the movement of ions and water, and allows mucus to build up on the lung epithelium. [[Long description](#)]

Epithelial tissues in some organs rely on the CFTR protein to transport ions (especially Cl⁻) across their cell membranes. The passage of ions through a six-sided channel is gated by another part of the CFTR protein, which binds to ATP. If there is insufficient activity of CFTR, an imbalance in ion concentration results, which disrupts the properties of the liquid layer that normally forms on the epithelial surface. In the lungs, this causes mucus to accumulate and can lead to infection. Defects in CFTR also affect pancreas, liver, intestines, and sweat glands – all of which need this ion transport. CFTR is also expressed at high levels in the salivary gland and bladder, but defects in CFTR function do not cause problems in these organs, probably because other ion transporters are able to compensate.

The video, *Cystic Fibrosis | Molecular Mechanism & Genetics*, by Hussain Biology (2018) on YouTube, discusses the genetic basis and mechanism by which cystic fibrosis occurs.



A YouTube element has been excluded from this version of the text. You can view it online here:

<https://opengenetics.pressbooks.tru.ca/?p=811>

Over one thousand different mutant alleles of CFTR have been described. Any mutation that prevents CFTR from sufficiently transporting ions can lead to cystic fibrosis (CF). Worldwide, the most common CFTR allele among CF patients is called $\Delta F508$ (delta-F508; or PHE508DEL), which is a deletion of three nucleotides that eliminates a phenylalanine from position 508 of the 1480 aa wild-type protein. Mutation $\Delta F508$ causes CFTR to be folded improperly in the endoplasmic reticulum (ER), which then prevents CFTR from reaching the cell membrane. $\Delta F508$ accounts for approximately 70% of CF cases in North America, with ~1/25 people of European descent being carriers. The high frequency of the $\Delta F508$ allele has led to speculation that it may confer some selective advantage to heterozygotes, perhaps by reducing dehydration during cholera epidemics, or by reducing susceptibility to certain pathogens that bind to epithelial membranes.

CFTR is also notable because it is one of the well-characterized genetic diseases for which a drug has been developed that compensates for the effects of a specific mutation. The drug, **Kalydeco (Ivacaftor)**, was approved by the FDA and

Health Canada in 2012, decades after the CFTR gene was first mapped to DNA markers (in 1985) and cloned (in 1989). Kalydeco is effective on only some CFTR mutations, most notably G551D (i.e., where glycine is substituted by aspartic acid at position 551 of the protein; GLY551ASP). This mutation is found in less than 5% of CF patients. The G551D mutation affects the ability of ATP to bind to CFTR and open the channel it for transport. Kalydeco compensates for this mutation by binding to CFTR and holding it in an open conformation. Kalydeco is expected to cost approximately \$250,000 per patient per year.

Media Attributions

- **Figure 7.6.1** [CFTR Protein Panels](#) by Lbudd14 (modified), [CC BY-SA 3.0](#), via Wikimedia Commons

Reference

Canadian Medical Association. (n.d.). 2012 Inductee: Lap-Chee Tsui, PhD. Canadian Medical Hall of Fame.

<https://cdnmedhall.ca/laureates/lapcheetsui>

Cystic Fibrosis Canada. (n.d.). What is Kalydeco? <https://www.cysticfibrosis.ca/our-programs/advocacy/access-to-medicines/kalydeco>

Hussain Biology. (2018, January 17). Cystic fibrosis | Molecular mechanism & genetics (video file). YouTube.

<https://www.youtube.com/watch?v=QfjIGXNey3g>

Tsui L. C. (1995). The cystic fibrosis transmembrane conductance regulator gene. *American journal of respiratory and critical care medicine*, 151(3 Pt 2), S47–S53. https://doi.org/10.1164/ajrccm/151.3_Pt_2.S47

Long Description

- **Figure 7.6.1** Wild-type and mutant forms of CFTR in the cell membrane: In wild-type, the CFTR ion channel is gated. When activated by ATP, the channel opens and allows ions to move across the membrane. In some CFTR mutants, the channel does not open. This prevents the movement of ions and water, and allows mucus to build up on the lung epithelium. [Back to [Figure 7.6.1](#)]

Chapter 7 Summary

The topics covered in this chapter can be summarized as follows:

- The Central Dogma describes the information flow from nucleic acids to proteins.
- Garrod's observations showed that there is a connection between genes and enzymes.
- Beadle and Tatum proposed that one gene encoded one enzyme.
- It was an example of how to screen for genetic mutants, and therefore characterize biochemical pathways or biological processes.
- Forward genetic screening aims to find the molecular basis for a certain phenotype whereas reverse genetic screening aims to find the phenotypic effects that a gene might have on the organism.
- Somatic mutations occur in non-reproductive cells which affect the current individual, while germline mutations occur in the gametes which affect future generations and not the individual.
- Mutation can alter a gene into different levels and types of expression.
- Not all base pair changes (mutations) cause detectable changes in an organism. The efficiency of mutant screening is limited by silent mutations, redundancy, and embryonic lethality.
- Cystic Fibrosis is a genetic disease caused by the mutation in the CFTR gene.

Key Terms in Chapter 7

Key Terms – The Central Dogma – Mutations and Biochemical Pathways

- arginine
- auxotroph
- Beadle & Tatum
- Central Dogma
- CFTR
- chromosome rearrangement
- complete medium
- Cystic Fibrosis (CF)
- DNA repair system
- dominant negative
- double strand break
- essential gene
- gain-of-function
- genetic analysis
- genetic screen for mutations
- genetic screen
- genotype
- germline cells
- inter-genic region
- loss-of-function
- metabolic pathway
- minimal medium
- mutant screen
- *Neurospora crassa*
- non-homologous end joining
- null
- one-gene: one-enzyme
- phenotype
- prototroph
- recessive lethal allele
- redundancy
- rescue
- reverse transcription
- silent mutation
- somatic cells
- transcription
- translation

Chapter 7 Study Questions

- Compare [Figure 7.3.1](#) and [Table 7.3.1](#) in [Section 7.3](#). Suppose you created three new arg⁻ mutation called mutants #1, #2, & #3. #1 grew on MM+cit and MM+arg, #2 grew on only MM+arg, while #3 grew on MM+ orn, cit or arg. Which genes are #1, 2, & 3 mutant in (A, B, or C)?
- Why was the Vitamin biotin always added the MM?
- Last century, A. Garrod, and later Beadle and Tatum, showed that genes encode enzymes. From what we know now, do all genes encode enzymes? Explain.
- Most mutant proteins differ from wild type (normal) by a single substitution at a specific amino acid site. Explain how some amino acid changes result in:
 - no loss of protein function,
 - only partial loss-of-function,
 - complete loss-of-function,
 - and how do changes at different amino acid sites result in the same complete loss-of-function.
- Some mutants result in the loss of a specific enzyme activity. Does this mean that no protein product is produced from that mutant gene?
- The molecular weight of the A and B chains of *coli* tryptophan synthase are 29,500 and 49,500, respectively. The size of the entire enzyme is 158,000.
 - If the average molecular weight of each amino acid is 110, then how many amino acids are present in each chain?
 - How many chains does the whole enzyme contain? Explain.
- Recall that *Neurospora* is orange coloured bread mould. This biochemical pathway below is how wild type cells become orange. None of the compounds are essential. Cells containing W are white, cells with Y are yellow, and cells with O are orange. Assume that the reactions will go to completion, if possible.

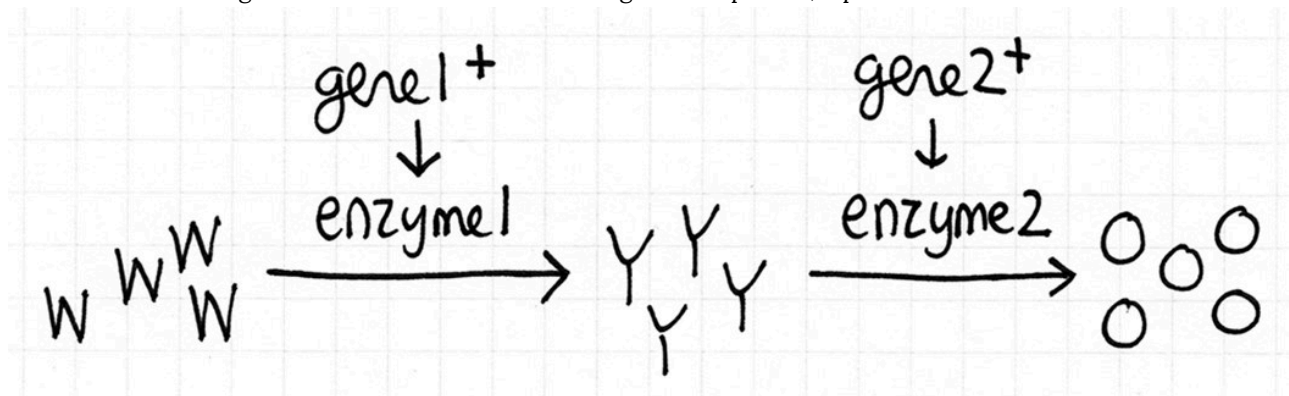

Fill in this table with the colours of the cell cultures.

Strain	MM+W	MM+Y	MM+O
gene1+ gene2+			
gene1- gene2+			
gene1+ gene2-			
gene1- gene2-			

8. You have a female fruit fly, whose father was exposed to a mutagen (she, herself, wasn't). Mating this female fly with another non-mutagenized, wild-type male produces offspring that all appear completely normal, except there are twice as many daughters as sons in the F1 progeny of this cross.
 - a. Propose a hypothesis to explain these observations.
 - b. How could you test your hypothesis?
9. You decide to use genetics to investigate how your favourite plant makes its flowers smell good.
 - a. What steps will you take to identify genes required for production of the sweet floral scent? Assume this plant is a self-pollinating diploid.
 - b. One of the recessive mutants you identified has fishy-smelling flowers, so you name the mutant (and the mutated gene) *fishy*. What do you hypothesize about the normal function of the wild-type *fishy* gene?
 - c. Another recessive mutant lacks floral scent altogether, so you call it *nosmell*. What could you hypothesize about the normal function of this gene?
10. Suppose you are only interested in finding dominant mutations that affect floral scent.
 - a. What do you expect to be the relative frequency of dominant mutations, compared to recessive mutations, and why?
 - b. How will you design your screen differently than in the previous question, to detect dominant mutations specifically?
 - c. Which kind of mutagen is most likely to produce dominant mutations, a mutagen that produces point mutations, or a mutagen that produces large deletions?
11. You are interested in finding genes involved in synthesis of proline (Pro), an amino acid normally synthesized by a particular model organism.
 - a. How would you design a mutant screen to identify genes required for Pro synthesis?
 - b. Imagine your screen identified ten mutants (#1 through #10) that grew poorly unless supplemented with Pro. How could you determine the number of different genes represented by these mutants?
 - c. If each of the four mutants represents a different gene, what will be the phenotype of the F1 progeny if any pair of the four mutants are crossed?
 - d. If each of the four mutants represents the same gene, what will be the phenotype of the F1 progeny if any pair of the four mutants are crossed?

Chapter 7 Answers

1.
 - Mutant strain #1 has a mutation in gene B (but genes A and C should be functional).
 - Mutant strain #2 is in gene C (but genes A and B should be functional).
 - Mutant strain #3 is in gene A (but genes B and C should be functional).
2. Even prototrophs cannot produce the vitamin biotin, so it must be added for any strain to grow. Wild type strains also lack the enzyme(s) for this biochemical pathway. Biotin is present in Complete Medium.
3. No, we now know that genes also encode tRNA, rRNA, and a variety of other functional RNAs.
4.
 - a. Changes in many amino acids do not cause a change in function. A specific amino acid is not required at that site for function to occur.
 - b. Changes in many amino acids can cause a minor loss in function. A specific amino acid at a site may be required for optimal function to occur.
 - c. Changes in some amino acids can cause a complete loss in function. Many specific amino acid are required at specific sites for any function to occur (e.g., the active site within an enzyme).
 - d. Any one of the amino acids changed in part (c) can result in a complete loss of function.
5. No, the gene can be transcribed into an mRNA and translated into a polypeptide, but the polypeptide is not functional because of a change in an amino acid.
6. Chain A has ~268, while chain B has 450. The entire enzyme has ~ 4 chains, two A and two B (a heterodimer).
7.
 - row 1 orange, orange, orange
 - row 2 white, orange, orange
 - row 3 yellow, yellow, orange
 - row 4 white, yellow, orange
8.
 - a. One possible explanation is that original mutagenesis resulted in a loss-of-function mutation in a gene that is essential for early embryonic development, and that this mutation is X-linked recessive in the female. Because half of the sons will inherit the X chromosome that bears this mutation, half of the sons will fail to develop beyond very early development and will not be detected among the F1. The proportion of male flies that were affected depends on what fraction of the female parent's gametes carried the mutation. In this case, it appears that half of the female's gametes carried the mutation.
 - b. To test whether a gene is X-linked, you can usually do a reciprocal cross. However, in this case it would be impossible to obtain adult male flies that carry the mutation; they are dead. If the hypothesis proposed in a) above is correct, then half of the females, and none of the living males in the F1 should carry the mutant allele. You could therefore cross F1 females to wild type males, and see whether the expected ratios were observed among the offspring (e.g., half of the F1 females should have a fewer male offspring than expected, while the other half of the F1 females and all of the males should have a roughly equal numbers of male and female offspring).
9.
 - a. Treat a population of seeds with a mutagen such as EMS. Allow these seeds to self-pollinate, and then allow the F1 generation to also self-pollinate. In the F2 generation, smell each flower to find individuals with abnormal scent.
 - b. The fishy gene appears to be required to make the normal floral scent. Because the flowers smell fishy in the absence of this gene, one possibility explanation of this is that fishy makes an enzyme that converts a fishy-smelling intermediate into a chemical that gives flowers their normal, sweet smell.

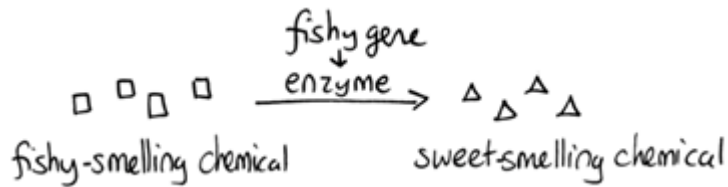

Note that although we show this

biochemical pathway as leading from the fishy-smelling chemical to the sweet-smelling chemical in one step, it is likely that there are many other enzymes that act after the fishy enzyme to make the final, sweet-smelling product. In either case, blocking the pathway at the step catalyzed by the *fishy* enzyme would explain the fishy smell.

- c. In *nosmell* plants, the normal sweet smell disappears. Unlike *fishy*, the sweet smell is not replaced by any intermediate chemical that we can easily detect. Thus, we cannot conclude where in the biochemical pathway the *nosmell* mutant is blocked; *nosmell* may normally therefore act either before or after *fishy* normally acts in the pathway:

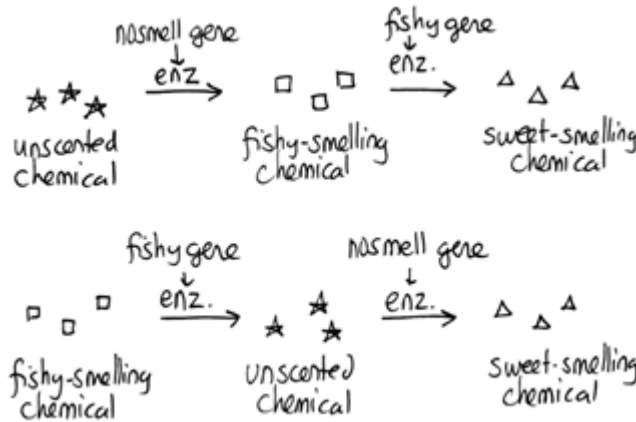

Alternatively, *nosmell* may not be part of the biosynthetic pathway for the sweet smelling chemical at all. It is possible that the normal function of this gene is to transport the sweet-smelling chemical into the cells from which it is released into the air, or maybe it is required for the development of those cells in the first place. It could even be something as general as keeping the plants healthy enough that they have enough energy to do things like produce floral scent.

10. a. Dominant mutations are generally much rarer than recessive mutations. This is because mutation of a gene tends to cause a loss of the normal function of this gene. In most cases, having just one normal (wt) allele is sufficient for normal biological function, so the mutant allele is recessive to the wt allele. Very rarely, rather than destroying normal gene function, the random act of mutation will cause a gene to gain a new function (e.g., to catalyze a new enzymatic reaction), which can be dominant (since it performs this new function whether the wt allele is present or not). This type of gain-of-function dominant mutation is very rare because there are many more ways to randomly destroy something than by random action to give it a new function (think of the example given in class of stomping on an iPod).
- b. Dominant mutations should be detectable in the F1 generation, so the F1 generation, rather than the F2 generation can be screened for the phenotype of interest.
- c. Large deletions, such as those caused by some types of radiation, are generally less likely than point mutations to introduce a new function into a protein: it is hard for a protein to gain a new function if the entire gene has been removed from the genome by deletion.
11. a. Mutagenize a wild type (auxotrophic) strain and screen for mutations that fail to grow on minimal media, but grow well on minimal media supplemented with proline.

- b. Take mutants #1-#10) and characterize them, based on:
 - i. genetic mapping of the mutants (different locations indicate different genes);
 - ii. different response to proline precursors (a different response suggests different genes);
 - iii. complementation tests among the mutations (if they complement then they are mutations in different genes).
- c. If the mutations are in different genes then the F1 progeny would be wild type (able to grow on minimal medium without proline).
- d. If the mutations are in the same gene then the F1 progeny would NOT be wild type (unable to grow on minimal medium without proline).

CHAPTER 8 - GENE INTERACTIONS

8.1 Introduction

Learning Objectives

- Discuss the concepts of recessive and dominant epistasis.
- Recall modified dihybrid phenotypic ratios which occur due to gene interactions.

Gene interaction occurs when genes at multiple loci determine a single phenotype: when the effects of genes at one locus depend on the presence of genes at other loci. The specific type of gene interaction whereby one gene masks the effect of another gene is called Epistasis. There are two main types of epistasis: dominant and recessive.

Generally, when epistasis is present, the four Mendelian genotypic classes (in a dihybrid cross) produce fewer than four observable phenotypes, because one gene masks the phenotypic effects of another. Often, the basis of epistasis is a gene pathway in which the expression of one gene depends on the function of a gene that precedes or follows it in the pathway. In **recessive epistasis**, the recessive allele of one gene masks the effects of either allele of the second gene, while in **dominant epistasis**, the dominant allele of one gene masks the effects of either allele of the second gene.

The principles of genetic analysis that we have described for a single locus (dominance/recessiveness) can be extended to the study of alleles at two different loci. While the analysis of two loci concurrently is required for genetic mapping, it can also reveal interactions between genes that affect the phenotype. Understanding these interactions is useful for both basic and applied research. Before discussing these interactions, we will first revisit Mendelian inheritance for two loci.

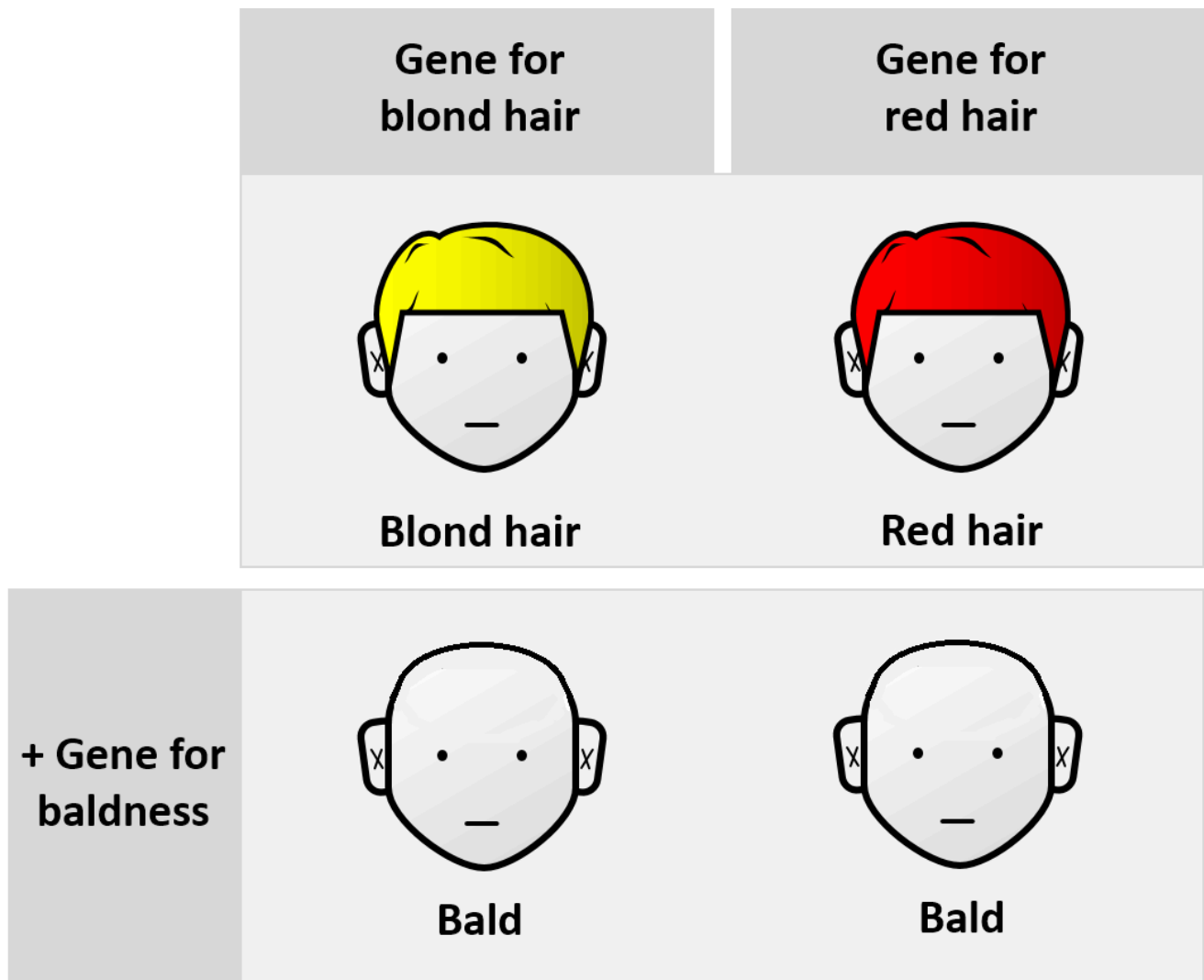
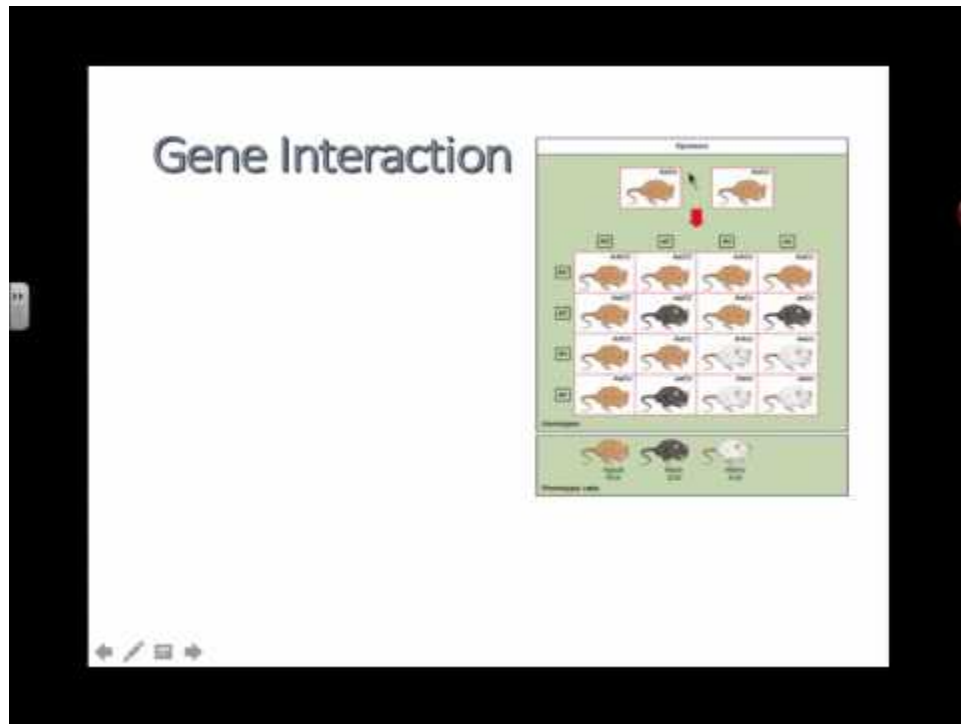

Figure 8.1.1 The Gene for Baldness is Epistatic to Those for Red Hair or Blond Hair. The baldness phenotype supersedes genes for hair colour and so the effects are non-additive. [[Long Description](#)]

The video below, *Gene Interaction IB Biology*, by Alex Lee (2016) on YouTube, provides an introductory discussion to gene interactions (epistasis).



A YouTube element has been excluded from this version of the text. You can view it online here:

<https://opengenetics.pressbooks.tru.ca/?p=826>

Media Attribution

- **Figure 8.1.1** [Epistatic hair](#) by Thomas Shafee, [CC BY 4.0](#), via Wikimedia Commons

Reference

Lee, A. (2016, January 24). Gene interaction (2016) IB biology (video file). YouTube. <https://www.youtube.com/watch?v=CzBOy48AfSQ>

Long Description

- **Figure 8.1.1** Gene interactions, whereby genes at multiple loci determine a single phenotype. Therefore, the effects of genes at one locus depend on the presence of genes at other loci. The gene for baldness is epistatic to those for red hair or blond hair. The baldness phenotype supersedes genes for hair colour and so the effects are non-additive. [Back to [Figure 8.1.1](#)]

8.2 Recall - Mendelian Dihybrid Crosses

Mendel's Second Law (A Quick Review)

To analyze the segregation of two traits (e.g., colour, wrinkle) at the same time, in the same individual, Mendel crossed a pure breeding line of green, wrinkled peas with a pure breeding line of yellow, round peas to produce F₁ progeny that were all green and round, and which were also **dihybrids**; they carried two alleles at each of two loci (**Figure 8.2.1**).

If the inheritance of seed color was truly independent of seed shape, then when the F₁ dihybrids were crossed to each other, a 3:1 ratio of one trait should be observed within each phenotypic class of the other trait (**Figure 8.2.1**). Using the product law, we would therefore predict that if $\frac{3}{4}$ of the progeny were green, and $\frac{3}{4}$ of the progeny were round, then $\frac{3}{4} \times \frac{3}{4} = \frac{9}{16}$ of the progeny would be both round and green. Likewise, $\frac{3}{4} \times \frac{1}{4} = \frac{3}{16}$ of the progeny would be both round and yellow, and so on. By applying the product rule to all these combinations of phenotypes, we can predict a **9:3:3:1** phenotypic ratio among the progeny of a dihybrid cross, if certain conditions are met, including the independent segregation of the alleles at each locus. Indeed, 9:3:3:1 is very close to the ratio Mendel observed in his studies of dihybrid crosses, leading him to state his Second Law, the **Law of Independent Assortment**, which we now express as follows: two loci assort independently of each other during gamete formation.

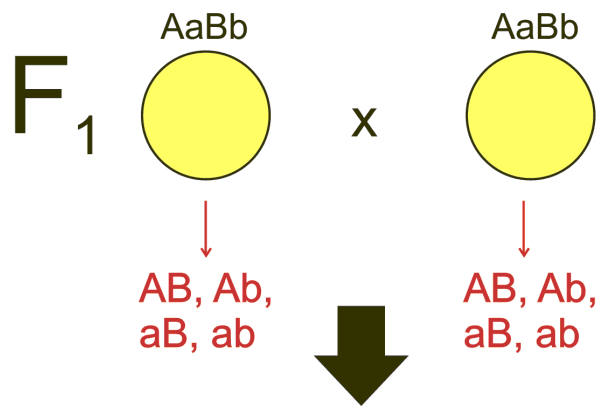

Figure 8.2.1 Punnett Square of Mendel's Law of Independent Assortment [[Long description](#)]

F₂	AB	Ab	aB	ab
AB	 AABB	 AABb	 AaBB	 AaBb
Ab	 AABb	 AAbb	 AaBb	 Aabb
aB	 AaBB	 AaBb	 aaBB	 aaBb
ab	 AaBb	 Aabb	 aaBb	 aabb

9 **:** **3** **:** **3** **:** **1**

Assumptions of the 9:3:3:1 Ratio

Both the product rule and the Punnett Square approaches showed that a 9:3:3:1 phenotypic ratio is expected among the progeny of a dihybrid cross, such as Mendel's $RrYy \times RrYy$. In making these expectations, we assumed:

1. Both loci assort independently;
2. One allele at each locus is completely dominant; and
3. Each of four possible phenotypes can be distinguished unambiguously, with no interactions between the two genes that would alter the phenotypes.

	<i>RY</i>	<i>Ry</i>	<i>rY</i>	<i>ry</i>
<i>RY</i>	<i>RRYY</i>	<i>RRYy</i>	<i>RrYY</i>	<i>RrYy</i>
<i>Ry</i>	<i>RRYy</i>	<i>RRyy</i>	<i>RrYy</i>	<i>Rryy</i>
<i>rY</i>	<i>RrYY</i>	<i>RrYy</i>	<i>rrYY</i>	<i>rrYy</i>
<i>ry</i>	<i>RrYy</i>	<i>Rryy</i>	<i>rrYy</i>	<i>rryy</i>

Figure 8.2.2 A Punnett Square Showing the Results of the Dihybrid Cross. Each of the four phenotypic classes is represented by a different color of shading. [[Long description](#)]

Deviations from the 9:3:3:1 phenotypic ratio may indicate that one or more of the above conditions is not met. For example, linkage of the two loci results in a distortion of the ratios expected from independent assortment. Also, if complete dominance is lacking (e.g., co-dominance or incomplete dominance), then the ratios will also be distorted. Finally, if there is an interaction between the two loci such that the four classes cannot be distinguished (which is the topic under consideration in this chapter), the ratio will also deviate from 9:3:3:1.

Modified ratios in the progeny of a dihybrid cross can therefore reveal useful information about the genes being investigated. Such interactions lead to **Modified Mendelian Ratios**.

Media Attributions

- **Figure 8.2.1** [Mendel 3b](#) by [Miguelferig](#), [CCO 1.0 Public Domain Dedication](#), via Wikimedia Commons
- **Figure 8.2.2** [Original](#) by Deyholos (2017), [CC BY-NC 3.0](#), Open Genetics Lectures

Reference

Deyholos, M. (2017). Figure 6. A Punnett square showing the results of the dihybrid cross [digital image]. In Locke, J., Harrington, M., Canham, L. and Min Ku Kang (Eds.), *Open Genetics Lectures, Fall 2017* (Chapter 17, p. 4). Dataverse/BCcampus. http://solr.bccampus.ca:8001/bcc/file/7a7b00f9-fb56-4c49-81a9-cfa3ad80e6d8/1/OpenGeneticsLectures_Fall2017.pdf

Long Descriptions

- **Figure 8.2.1** A Punnett square shows the production of the F₂ generation in a typical dihybrid cross, looking at the seed colour and seed shape of a particular plant. Crossing the two heterozygotes in the F₁ generation produces offspring in the F₂ generation in the typical 9:3:3:1 ratio. [Back to [Figure 8.2.1](#)]
- **Figure 8.2.2** A Punnett square shows the results of the typical dihybrid cross, where phenotypes are produced in a 9:3:3:1 ratio. This is indicative of independent assortment of the two genes under consideration, as well as complete dominance between alleles for each trait. [Back to [Figure 8.2.2](#)]

8.3 Epistasis and Other Gene Interactions

Some dihybrid crosses produce a phenotypic ratio that differs from the typical 9:3:3:1. These include 9:3:4, 12:3:1, 9:7, or 15:1. Note that each of these modified ratios can be obtained by summing one or more of the 9:3:3:1 classes expected from our original dihybrid cross. In the following sections, we will look at some modified phenotypic ratios obtained from dihybrid crosses and what they might tell us about the interactions between the genes involved.

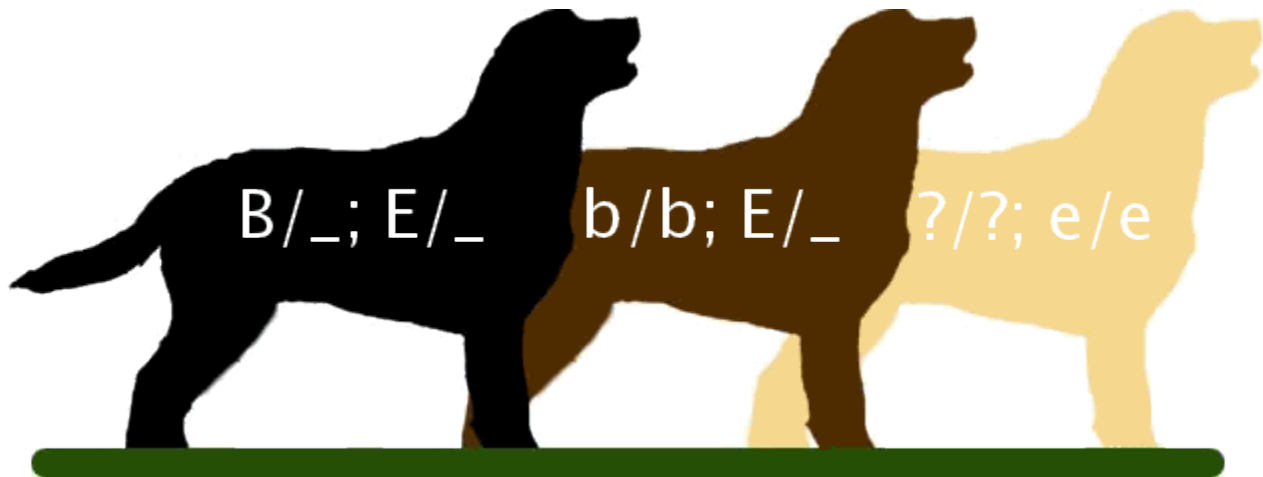

Figure 8.3.1 Three Recognizable Coat Colours in Labrador Retrievers with their Respective Genotypes that Underlie Each Phenotype. Coat colour in this breed is controlled by 2 genes. [[Long description](#)]

Recessive Epistasis

Epistasis (which means “standing upon”) occurs when the phenotype of one locus masks, or prevents, the phenotypic expression of another locus. Thus, following a dihybrid cross, fewer than the typical four phenotypic classes will be observed with epistasis. As we have already discussed, in the absence of epistasis, there are four phenotypic classes among the progeny of a dihybrid cross. The four phenotypic classes correspond to the genotypes: $A_B_$, A_bb , $aaB_$, and $aabb$. If either of the singly homozygous recessive genotypes (i.e., A_bb or $aaB_$) has the same phenotype as the double homozygous recessive ($aabb$), then a **9:3:4** phenotypic ratio will be obtained.

For example, in the Labrador Retriever breed of dogs (**Figure 8.3.1**), the B locus encodes a gene for an important step in the production of melanin. The dominant allele, B is more efficient at pigment production than the recessive b allele, thus $B_$ hair appears black, and bb hair appears brown. A second locus, which we will call E, controls the deposition of melanin in the hairs. At least one functional E allele is required to deposit any pigment, whether it is black or brown. Thus, all retrievers that are ee fail to deposit any melanin (and so appear pale yellow-white), regardless of the genotype at the B locus (**Figure 8.3.1**, right side).

The ee genotype is therefore said to be **epistatic** to both the B and b alleles, since the homozygous ee phenotype masks the phenotype of the B locus. The B/b locus is said to be **hypostatic** to the ee genotype. Because the masking allele is, in this case, recessive. This is called **recessive epistasis**. A table showing all of the possible progeny genotypes and their phenotypes is shown in **Figure 8.3.2**.

	<i>EB</i>	<i>Eb</i>	<i>eB</i>	<i>eb</i>
<i>EB</i>	<i>EEBB</i>	<i>EEBb</i>	<i>EeBB</i>	<i>EeBb</i>
<i>Eb</i>	<i>EEBb</i>	<i>EEbb</i>	<i>EeBb</i>	<i>Eebb</i>
<i>eB</i>	<i>EeBB</i>	<i>EeBb</i>	<i>eeBB</i>	<i>eeBb</i>
<i>eb</i>	<i>EeBb</i>	<i>Eebb</i>	<i>eeBb</i>	<i>eebb</i>

Figure 8.3.2 Genotypes and Phenotypes Among the Progeny of a Dihybrid Cross of Labrador Retrievers Heterozygous for Two Loci Affecting Coat Colour. The phenotypes of the progeny are indicated by the shading of the cells in the table: black coat (black, *E_B_*); chocolate coat (brown, *E_bb*); yellow coat (yellow, *eeB_* or *eebb*). [[Long description](#)]

Dominant Epistasis

In some cases, a dominant allele at one locus may mask the phenotype of a second locus. This is called **dominant epistasis**. This produces a segregation ratio of **12:3:1**, which can be viewed as a modification of the 9:3:3:1 ratio. Here, the *A_B_* class is combined with one of the other genotypic classes (9+3) that contains a dominant allele. One of the best-known examples of a 12:3:1 segregation ratio is fruit colour in some types of squash (**Figure 8.3.3**). Alleles of a locus that we will call *B* produce either yellow (*B_*) or green (*bb*) fruit. However, in the presence of a dominant allele at a second locus that we call *A*, no pigment is produced at all, and fruit are white. The dominant *A* allele, is therefore, epistatic to both *B* and *bb* combinations (**Figure 8.3.4**). One possible biological interpretation of this segregation pattern, is that the function of the *A* allele somehow blocks an early stage of pigment synthesis, before either yellow or green pigments are produced.



Figure 8.3.3 Green, Yellow, and White Fruits of Squash. [[Long description](#)]

	<i>AB</i>	<i>Ab</i>	<i>aB</i>	<i>ab</i>
<i>AB</i>	<i>AABB</i>	<i>AABb</i>	<i>AaBB</i>	<i>AaBb</i>
<i>Ab</i>	<i>AABb</i>	<i>AAbb</i>	<i>AaBb</i>	<i>Aabb</i>
<i>aB</i>	<i>AaBB</i>	<i>AaBb</i>	<i>aaBB</i>	<i>aaBb</i>
<i>ab</i>	<i>AaBb</i>	<i>Aabb</i>	<i>aaBb</i>	<i>aabb</i>

Figure 8.3.4 Genotypes and Phenotypes Among the Progeny of a Dihybrid Cross of Squash Plants Heterozygous for Two Loci Affecting Fruit Colour [[Long description](#)]

Duplicate Gene Action

When a dihybrid cross produces progeny in two phenotypic classes in a 15:1 ratio, this can be because the two loci's gene products have the same (redundant) functions within the same biological pathway. With yet another pigmentation pathway example, wheat shows this **duplicate gene action**. The biosynthesis of red pigment near the surface of wheat seeds (**Figure 8.3.5**) involves many genes, two of which we will label A and B. Normal, red colouration of the wheat seeds is maintained if function of either of these genes is lost in a homozygous mutant (e.g., in either $aaB_$ or A_bb). Only the doubly recessive mutant ($aabb$), which lacks function of both genes, shows a phenotype that differs from that produced by any of the other genotypes (**Figure 8.3.6**). A reasonable interpretation of this result is that both genes encode the same biological function, and either one alone is sufficient for the normal activity of that pathway.



Figure 8.3.5 Red Wheat Seeds [[Long description](#)]

	<i>AB</i>	<i>Ab</i>	<i>aB</i>	<i>ab</i>
<i>AB</i>	<i>AABB</i>	<i>AABb</i>	<i>AaBB</i>	<i>AaBb</i>
<i>Ab</i>	<i>AABb</i>	<i>AAbb</i>	<i>AaBb</i>	<i>Aabb</i>
<i>aB</i>	<i>AaBB</i>	<i>AaBb</i>	<i>aaBB</i>	<i>aaBb</i>
<i>ab</i>	<i>AaBb</i>	<i>Aabb</i>	<i>aaBb</i>	<i>aabb</i>

Figure 8.3.6 Genotypes and Phenotypes Among the Progeny of a Dihybrid Cross of a Wheat Plants Heterozygous for Two Loci Affecting Seed Colour [\[Long description\]](#)

Complementary Gene Action

The progeny of a dihybrid cross may produce just two phenotypic classes, in an approximately **9:7** ratio. An interpretation of this ratio is that the loss of function of either A or B gene has the same phenotype as the loss of function of both genes. This is due to **complementary gene action**; meaning the functions of both genes work together to produce a final product. For example, consider a simple biochemical pathway in which a colourless substrate is converted by the action of gene A to another colourless product, which is then converted by the action of gene B to a

a)

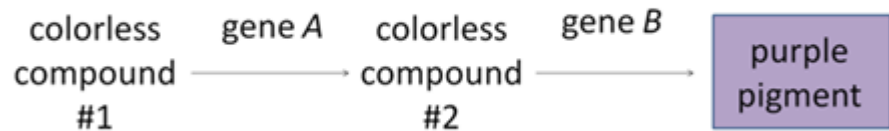

visible pigment (**Figure 8.3.7**).

b) **Two subunits of one enzyme**

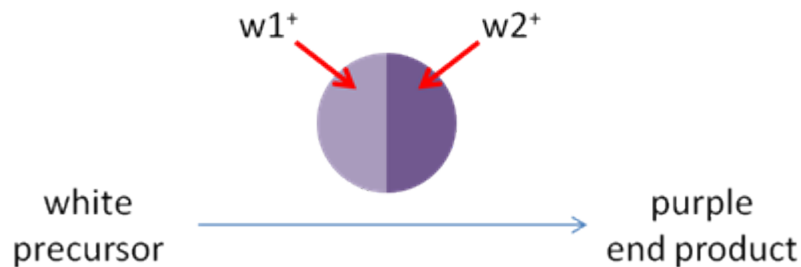

c) One transcription factor and one enzyme

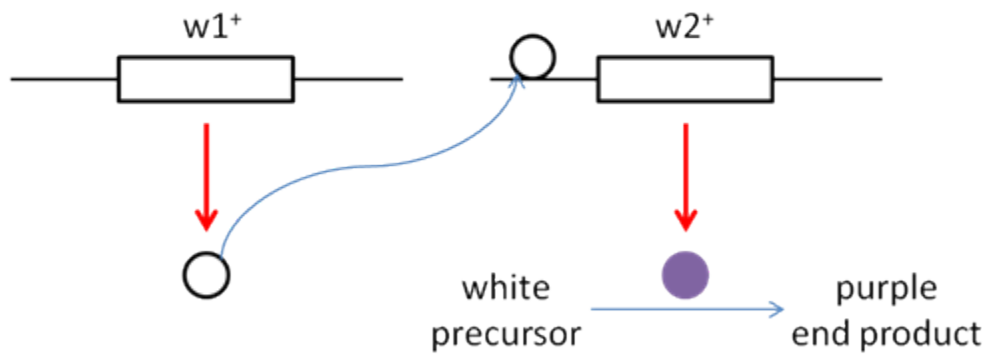

Figure 8.3.7 a) A simplified biochemical pathway showing complementary gene action of A and B. Note that in this case, the same phenotypic ratios would be obtained if gene B acted before gene A in the pathway b) biochemical pathway showing two subunits of one enzyme c) biochemical pathway showing one transcription factor and one enzyme. [[Long description](#)]

Loss of function of either A or B, or both, will have the same result – no pigment production. Thus A_bb , $aaB_$, and $aabb$ will all be colourless, while only $A_B_$ genotypes will produce pigmented product (**Figure 8.3.8**). The modified 9:7 ratio may, therefore, be obtained when two genes act together in the same biochemical pathway, and when their loss of function phenotypes are indistinguishable from each other or from the loss of both genes. There are also other possible biochemical explanations for complementary gene action.

	<i>AB</i>	<i>Ab</i>	<i>aB</i>	<i>ab</i>
<i>AB</i>	<i>AABB</i>	<i>AABb</i>	<i>AaBB</i>	<i>AaBb</i>
<i>Ab</i>	<i>AABb</i>	<i>AAbb</i>	<i>AaBb</i>	<i>Aabb</i>
<i>aB</i>	<i>AaBB</i>	<i>AaBb</i>	<i>aaBB</i>	<i>aaBb</i>
<i>ab</i>	<i>AaBb</i>	<i>Aabb</i>	<i>aaBb</i>	<i>aabb</i>

Figure 8.3.8 Genotypes and Phenotypes Among the Progeny of a Dihybrid Cross of a Hypothetical Plant Heterozygous for Two Loci Affecting Flower Colour [[Long description](#)]

Genetic Suppression and Enhancement

A **suppressor mutation** is a type of mutation that usually had no phenotype of its own, but act to suppress (makes more wildtype, less mutant) the phenotypic expression of another mutation that already exists in an organism. On the other hand, **enhancer mutations** have the opposite effect of suppressor mutations. They make the phenotype more mutant and less wild type (enhance the mutant phenotype).

For example, if a fly has a **whitemottled** (w^m) phenotype, it can be suppressed to look more like **white+** phenotype by a dominant *Suppressor* mutation (S^-), or *Enhanced* to look more like **white-** by a dominant enhancer mutation (E^-) (**Figure 8.3.9**). Note that the w^m allele is recessive to w^+ but dominant to w^- .

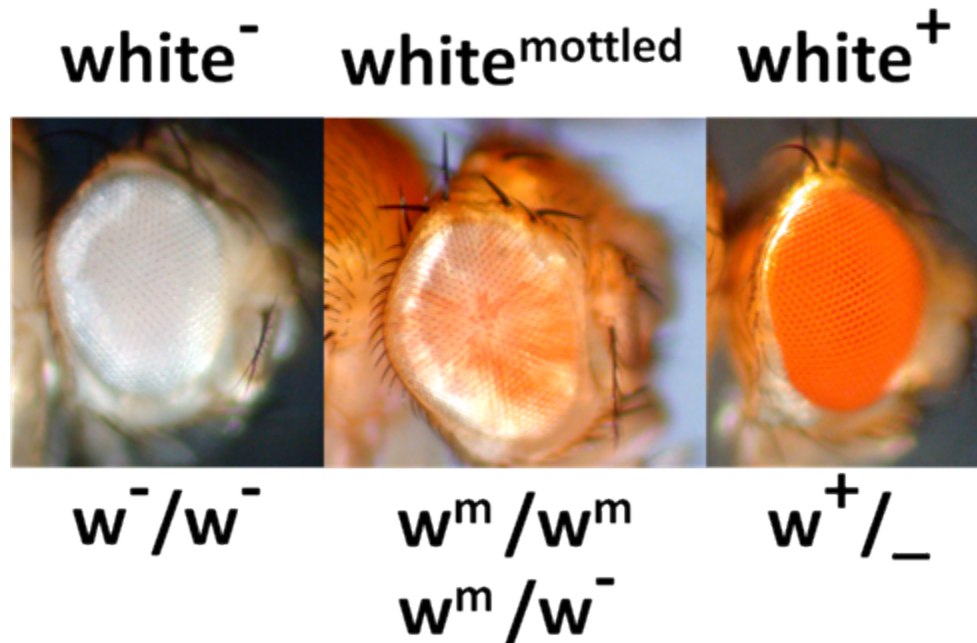

Figure 8.3.9 Mutation in the White Gene Impacts the Pigmentation in *Drosophila* Eyes. Note. White mottled is recessive to w^+ and dominant to w^- [[Long description](#)]

The suppressor mutation can be within the original gene, itself (**intragenic**), or outside the gene, at some other gene elsewhere in the genome (**extragenic**). For example, a frameshift mutation caused by a deletion in a gene can be reverted, or suppressed, by an insertion in the same gene to restore the original reading frame (intragenic suppressor mutation). A case of an extragenic suppressor mutation, on the other hand, can occur when a mutant phenotype caused by mutation in gene A is suppressed by a mutation in gene B. In extragenic suppressor mutation, there are two types of suppressor mutations: (1) **dominant suppression** and (2) **recessive suppression**.

Dominant Suppression

In **dominant suppression**, the mutant suppressor allele is dominant to the wild type suppressor allele. Therefore, one mutant suppressor allele is sufficient to suppress the mutant phenotype. For example, in **Figure 8.3.10**, the *Su* gene represents the suppressor gene. Flies that have at least one Su^- allele, even though they have homozygous recessive w^m/w^m genotype, will show a wild-type (w^+) phenotype. A fly will have w^m phenotype only if it has homozygous

recessive Su^+/Su^+ genotype. If $w^+/w^mottled; Su^+/Su^-$ flies are crossed together, the ratio of white+ (wild type) to whitemottled (mutant) would be 15:1.

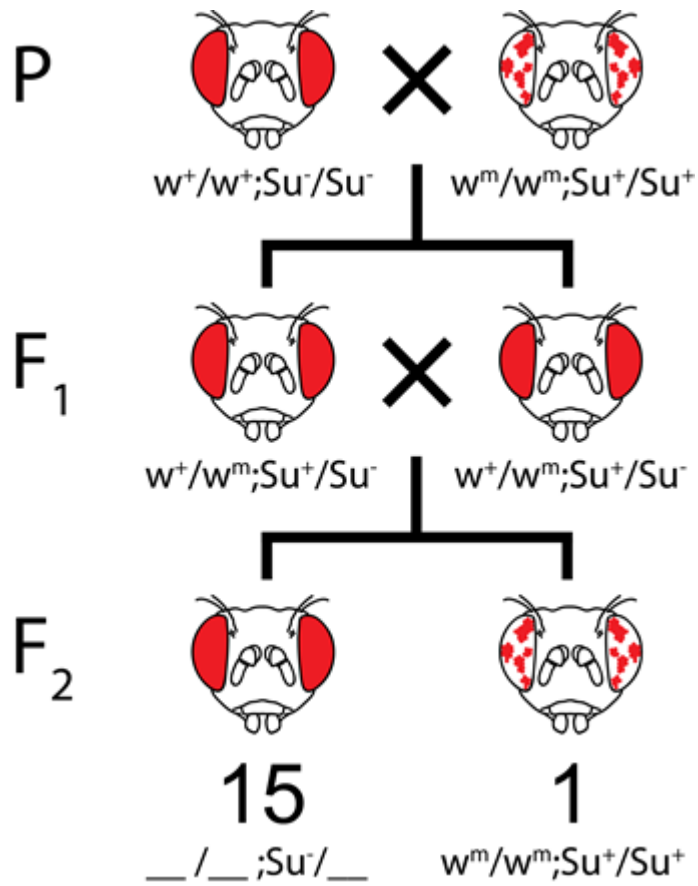

	<i>AB</i>	<i>Ab</i>	<i>aB</i>	<i>ab</i>
<i>AB</i>	<i>AABB</i>	<i>AABb</i>	<i>AaBB</i>	<i>AaBb</i>
<i>Ab</i>	<i>AABb</i>	<i>AAbb</i>	<i>AaBb</i>	<i>Aabb</i>
<i>aB</i>	<i>AaBB</i>	<i>AaBb</i>	<i>aaBB</i>	<i>aaBb</i>
<i>ab</i>	<i>AaBb</i>	<i>Aabb</i>	<i>aaBb</i>	<i>aabb</i>

Figure 8.3.10 Dominant Suppression – *Drosophila* Cross and its Punnett Square Showing the Effects of Dominant Suppression of *Su* Gene on the *White* gene. Note that *A* = *white*⁺, *a* = *whitemottled*, *B* = *Su*⁺ *b* = *Su*⁻, and ____ (blank) = any allele. [\[Long description\]](#)

Recessive Suppression

On the other hand, in **recessive suppression**, the mutant suppressor allele is recessive to the wild type suppressor allele. Therefore, two of the mutant alleles are needed to suppress the *w^m* (mottled) phenotype. For example, in **Figure 8.3.10**, flies that have at least one *w⁺* allele will show a wild-type phenotype. Also, flies that have *su⁻/su⁻* alleles will have wildtype phenotype since two mutant alleles can suppress the *white* gene mutation. On the other hand, flies that have the *w^mw^m* alleles will have mottled phenotype unless they have homozygous *su⁻* alleles. If *w⁺/w^m*; *Su⁺/Su⁻* flies are crossed together, the ratio of white⁺ (wild type) to whitemottled (mutant) would be 13:3.

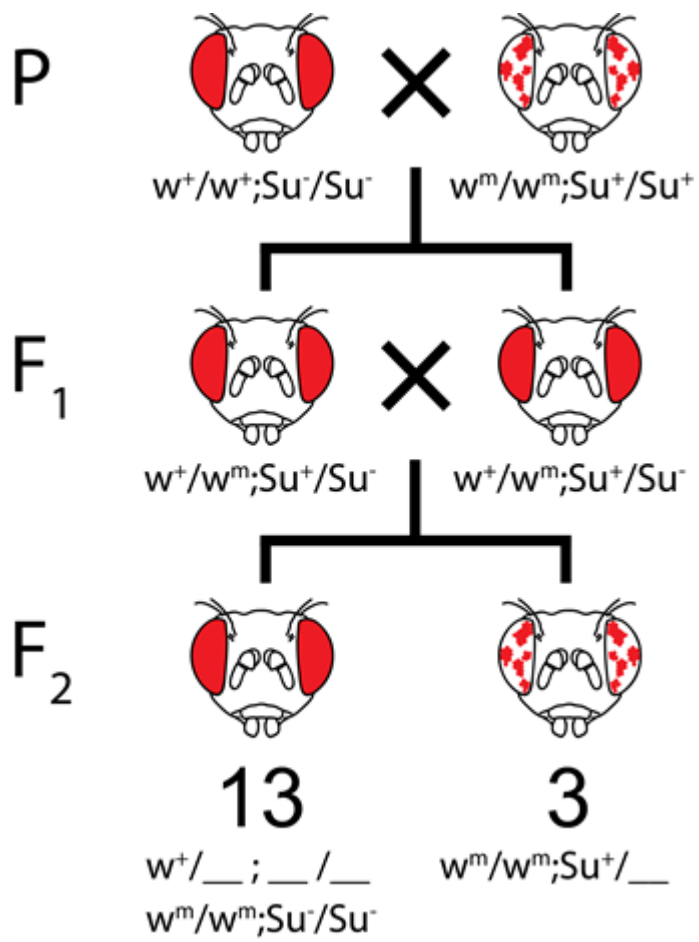

	<i>AB</i>	<i>Ab</i>	<i>aB</i>	<i>ab</i>
<i>AB</i>	<i>AABB</i>	<i>AABb</i>	<i>AaBB</i>	<i>AaBb</i>
<i>Ab</i>	<i>AABb</i>	<i>AAbb</i>	<i>AaBb</i>	<i>Aabb</i>
<i>aB</i>	<i>AaBB</i>	<i>AaBb</i>	<i>aaBB</i>	<i>aaBb</i>
<i>ab</i>	<i>AaBb</i>	<i>Aabb</i>	<i>aaBb</i>	<i>aabb</i>

Figure 8.3.11 Recessive Suppression – *Drosophila* Cross and its Punnett Square Showing the Effects of Recessive Suppression of *Su* Gene on the White Gene. Note that *A* = white+, *a* = whitemottled, *B* = *Su*+ *b* = *Su*-, and ____ (blank) = any allele. [\[Long description\]](#)

Summary of Modifications

Table 8.3.1 Summary of the Modifications of Typical F₂ Mendelian Ratios Obtained, Based on the Type of Gene Interaction

Ratio	Description	Interaction
9:3:3:1	Complete dominance at both gene pairs; new phenotypes result from interaction between dominant alleles, as well as from interaction between both homozygous recessives	None (Independent Assortment)
9:4:3	Complete dominance at both gene pairs; however, when one gene is homozygous recessive, it masks the phenotype of the other gene	Recessive epistasis
9:7	Complete dominance at both gene pairs; however, when either gene is homozygous recessive, it masks the effect of the other gene	Duplicate recessive epistasis
12:3:1	Complete dominance at both gene pairs; however, when one gene is dominant, it masks the phenotype of the other gene	Dominant epistasis
15:1	Complete dominance at both gene pairs; however, when either gene is dominant, it masks the effects of the other gene	Duplicate dominant epistasis
13:3	Complete dominance at both gene pairs; however, when either gene is dominant, it masks the effects of the other gene	Dominant and recessive epistasis
9:6:1	Complete dominance at both gene pairs; however, when either gene is dominant, it masks the effects of the other gene	Duplicate interaction

Media Attributions

- **Figure 8.3.1** [LabRetColors](#) by Elizabeth Arellano, [CC BY 3.0](#), via Wikipedia
- **Figure 8.3.2** [Original](#) by Locke (2017), [CC BY-NC 3.0](#), Open Genetics Lectures
- **Figure 8.3.3** [decorative squashes](#) by Lisa Ann Yount, [CC0 1.0](#), via Flickr
- **Figure 8.3.4** [Original](#) by Deyholos (2017), [CC BY-NC 3.0](#), Open Genetics Lectures
- **Figure 8.3.5** [Wheat](#) by Keith Ewing, [CC BY-NC 2.0](#), via Flickr
- **Figure 8.3.6** [Original](#) by Deyholos (2017), [CC BY-NC 3.0](#), Open Genetics Lectures
- **Figure 8.3.7** [Original](#) by Deyholos/Kang (2017), [CC BY-NC 3.0](#), Open Genetics Lectures
- **Figure 8.3.8** [Original](#) by Deyholos (2017), [CC BY-NC 3.0](#), Open Genetics Lectures
- **Figure 8.3.9** [Original](#) by Locke (2017), [CC BY-NC 3.0](#), Open Genetics Lectures
- **Figure 8.3.10** [Original](#) by Kang (2017), [CC BY-NC 3.0](#), Open Genetics Lectures
- **Figure 8.3.11** [Original](#) by Kang (2017), [CC BY-NC 3.0](#), Open Genetics Lectures

References

Deyholos, M. (2017). Figures: 5, 7, 9 & 11 Genotypes and phenotypes... [digital images]. In Locke, J., Harrington, M., Canham, L. and Min Ku Kang (Eds.), *Open Genetics Lectures, Fall 2017* (Chapter 26, p. 3). Dataverse/ BCcampus. http://solr.bccampus.ca:8001/bcc/file/7a7b00f9-fb56-4c49-81a9-cfa3ad80e6d8/1/OpenGeneticsLectures_Fall2017.pdf

Kang, M. K. (2017). Figures: 13. Dominant suppression; 14. Recessive suppression [digital images]. In Locke, J., Harrington, M., Canham, L. and Min Ku Kang (Eds.), *Open Genetics Lectures, Fall 2017* (Chapter 26, p. 6). Dataverse/

BCcampus. http://solr.bccampus.ca:8001/bcc/file/7a7b00f9-fb56-4c49-81a9-cfa3ad80e6d8/1/OpenGeneticsLectures_Fall2017.pdf

Locke, J. (2017). Figures: 5. Genotypes and phenotypes...; and 12. Mutation in the white gene...[digital images]. In Locke, J., Harrington, M., Canham, L. and Min Ku Kang (Eds.), *Open Genetics Lectures, Fall 2017* (Chapter 26, p. 3; 5). Dataverse/ BCcampus. http://solr.bccampus.ca:8001/bcc/file/7a7b00f9-fb56-4c49-81a9-cfa3ad80e6d8/1/OpenGeneticsLectures_Fall2017.pdf

Long Descriptions

- **Figure 8.3.1** Three typical colours of Labrador retrievers are shown along with expected genotypes – B_E_ would be black; bbE_ would be brown and __ee would be yellow. Coat colour in this breed of dog is controlled by two genes which are epistatic in nature. [Back to [Figure 8.3.1](#)]
- **Figure 8.3.2** A Punnett square shows genotypes and phenotypes among the progeny of a Dihybrid Cross of Labrador Retrievers, which are heterozygous for two loci affecting coat colour. The phenotypes of the progeny are indicated by the shading of the cells in the table: black coat (black, E_B_); chocolate coat (brown, E_bb); yellow coat (yellow, eeB_ or eebb). [Back to [Figure 8.3.2](#)]
- **Figure 8.3.3** A variety of colours of squash vegetables represent the effects of dominant epistasis. Alleles of a locus that we will call “B” produce either yellow (B_) or green (bb) fruit. However, in the presence of a dominant allele at a second locus that we’ll call “A,” no pigment is produced at all, and fruit is white. [Back to [Figure 8.3.3](#)]
- **Figure 8.3.4** A Punnett square shows the genotypes and phenotypes among the progeny of a dihybrid cross of squash plants heterozygous for two loci affecting fruit colour. The typical 12:3:1 ratio of dominant epistasis is demonstrated. [Back to [Figure 8.3.4](#)]
- **Figure 8.3.5** Image showing a field of red wheat seeds. The biosynthesis of red pigment near the surface of wheat seeds is controlled by the actions of multiple genes. Two of these exhibit duplicate gene action, whereby the gene products have the same function within the same biological pathway. [Back to [Figure 8.3.5](#)]
- **Figure 8.3.6** A Punnett square shows genotypes and phenotypes among the progeny of a dihybrid cross of wheat plants, which are heterozygous for two loci affecting seed colour. The typical 15:1 ratio of duplicate gene action is demonstrated here. [Back to [Figure 8.3.6](#)]
- **Figure 8.3.7** The loss of function of one of two genes responsible for the production of a final product in a biochemical pathway results in a phenotype representative, as the loss of function of both genes is called complementary gene action. Part a) shows a simplified biochemical pathway showing complementary gene action of A and B. In this case, the same phenotypic ratios would be obtained if gene B acted before gene A in the pathway. Part b) shows the biochemical pathway of two subunits of one enzyme, and Part c) shows the biochemical pathway of one transcription factor and one enzyme. [Back to [Figure 8.3.7](#)]
- **Figure 8.3.8** A Punnett square shows genotypes and phenotypes among the progeny of a dihybrid cross of a hypothetical plant heterozygous for two loci affecting flower colour. The typical 9:7 ratio of complementary gene action is demonstrated here. [Back to [Figure 8.3.8](#)]
- **Figure 8.3.9** Three different possible pigments in Drosophila eyes whereby a mutation in the white gene impacts the pigmentation. White mottled is recessive to white⁺ and dominant to white⁻. This is an example of both a dominant suppressor mutation as well as an enhancer mutation. [Back to [Figure 8.3.9](#)]
- **Figure 8.3.10** A Punnett square shows the results of dominant suppression and the typical 15:1 ratio obtained in the F₂ generation. The Su gene shows dominant suppression of the white gene. In dominant suppression, the mutant suppressor allele is dominant to the wild type suppressor allele. Therefore, one mutant suppressor allele is sufficient to suppress the mutant phenotype. [Back to [Figure 8.3.10](#)]
- **Figure 8.3.11** A Punnett square shows the results of recessive suppression and the typical 13:3 ratio obtained in the

F2 generation. Here, the Su gene shows recessive suppression of the white gene. In recessive suppression, the mutant suppressor allele is recessive to the wild type suppressor allele. Therefore, two mutant alleles are needed to suppress the white or mottled phenotype. [Back to [Figure 8.3.11](#)]

8.4 Polygenic Inheritance

Continuous Variation

Most of the phenotypic traits commonly used in introductory genetics are qualitative. This means the phenotype exists in only two (or possibly a few more) discrete, alternative forms, such as purple or white flowers, or red or white eyes. These qualitative traits are therefore said to exhibit **discrete variation**. On the other hand, many interesting and important traits exhibit **continuous variation**, meaning they exhibit a continuous range of phenotypes that are usually measured quantitatively, such as intelligence, body mass, blood pressure in animals (including humans), and yield, water use, or vitamin content in crops. Traits with continuous variation are often complex, and do not show the simple Mendelian segregation ratios (e.g., 3:1) observed with some qualitative traits. Many complex traits are heavily influenced by the environment; nevertheless, complex traits can often have a component that is heritable, and which must therefore involve one or more genes.

How can genes, which are inherited (in the case of a diploid) as, at most, two variants each, explain the wide range of continuous variation observed for many traits? The lack of an immediately obvious explanation to this question was one of the early objections to Mendel's explanation of the mechanisms of heredity. However, upon further consideration, it becomes clear that the more loci that contribute to the trait, the more phenotypic classes may be observed for that trait (**Figure 8.4.1**).

	<i>ABC</i>	<i>ABc</i>	<i>AbC</i>	<i>Abc</i>	<i>aBC</i>	<i>aBc</i>	<i>abC</i>	<i>abc</i>
<i>ABC</i>	<i>AABBCC</i>	<i>AABBcC</i>	<i>AABbCC</i>	<i>AABbCc</i>	<i>AaBBCC</i>	<i>AaBBcC</i>	<i>AabbCC</i>	<i>AabbCc</i>
<i>ABc</i>	<i>AABBcC</i>	<i>AABBcc</i>	<i>AABbCc</i>	<i>AABbcc</i>	<i>AaBBcC</i>	<i>AaBBcc</i>	<i>AabbCc</i>	<i>Aabbcc</i>
<i>AbC</i>	<i>AABbCC</i>	<i>AABbCc</i>	<i>AAbbCC</i>	<i>AAbbCc</i>	<i>AaBbCC</i>	<i>AaBbCc</i>	<i>AabbCC</i>	<i>AabbCc</i>
<i>Abc</i>	<i>AABbCc</i>	<i>AABbcc</i>	<i>AAbbCc</i>	<i>AAbbcc</i>	<i>AaBbCc</i>	<i>AaBbcc</i>	<i>AabbCc</i>	<i>Aabbcc</i>
<i>aBC</i>	<i>AaBBCC</i>	<i>AaBBcC</i>	<i>AaBbCC</i>	<i>AaBbCc</i>	<i>aaBBCC</i>	<i>aaBBcC</i>	<i>aaBbCC</i>	<i>aaBbCc</i>
<i>aBc</i>	<i>AaBBcC</i>	<i>AaBBcc</i>	<i>AaBbCc</i>	<i>AaBbcc</i>	<i>aaBbCc</i>	<i>aaBbcc</i>	<i>aabBcC</i>	<i>aabBcc</i>
<i>abC</i>	<i>AaBbCC</i>	<i>AaBbCc</i>	<i>AabbCC</i>	<i>AabbCc</i>	<i>aaBbCC</i>	<i>aaBbCc</i>	<i>aabBCC</i>	<i>aabBcC</i>
<i>abc</i>	<i>AaBbCc</i>	<i>AaBbcc</i>	<i>AabbCc</i>	<i>Aabbcc</i>	<i>aaBbCc</i>	<i>aaBbcc</i>	<i>aabbCc</i>	<i>aabbcc</i>

	<i>A</i>	<i>a</i>
<i>A</i>	<i>AA</i>	<i>Aa</i>
<i>a</i>	<i>Aa</i>	<i>aa</i>

	<i>AB</i>	<i>Ab</i>	<i>aB</i>	<i>ab</i>
<i>AB</i>	<i>AABB</i>	<i>AABb</i>	<i>AaBB</i>	<i>AaBb</i>
<i>Ab</i>	<i>AABb</i>	<i>AAbb</i>	<i>AaBb</i>	<i>Aabb</i>
<i>aB</i>	<i>AaBB</i>	<i>AaBb</i>	<i>aaBB</i>	<i>aaBb</i>
<i>ab</i>	<i>AaBb</i>	<i>Aabb</i>	<i>aaBb</i>	<i>aabb</i>

Figure 8.4.1 Punnett Squares for One, Two, or Three Loci. This is a simplified example of up to three semi-dominant genes, and in each case the effect on the phenotype is additive, meaning the more “upper case” alleles present, the stronger the phenotype. A comparison of the Punnett squares and the associated phenotypes shows, under these conditions, the larger the number of genes that affect a trait, the more intermediate phenotypic classes will be expected. [Long description]

If the number of phenotypic classes is sufficiently large (as with three or more loci), individual classes may become indistinguishable (particularly when environmental effects are included), and the phenotype appears as a continuous variation (**Figure 8.4.2**). Thus, quantitative traits are sometimes called **polygenic traits**, because it is assumed that their phenotypes are controlled by the combined activity of many genes. Note that this does not imply that each of the individual genes has an equal influence on a polygenic trait – some may have a major effect, while others only minor. Furthermore, any single gene may influence more than one trait, whether these traits are quantitative or qualitative traits.

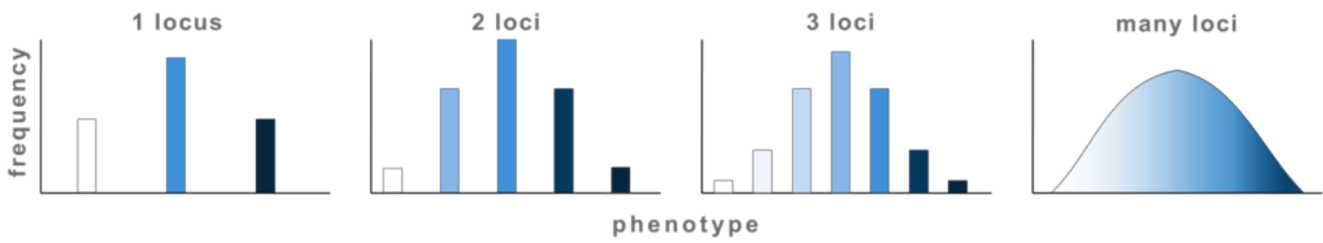

Figure 8.4.2 The More Loci that Affect a Trait, the Larger the Number of Phenotypic Classes Can Be Expected. For some traits, the number of contributing loci is so large that the phenotypic classes blend together in apparently continuous variation. [Long description]

The video, *Polygenic Inheritance*, by AK Lectures (2015) on YouTube, discusses the genetic basis of Polygenic Inheritance.

Polygenic Inheritance

In humans, many traits such as height and skin color, are controlled by many different pairs of alleles. Polygenic inheritance refers to the phenomenon by which multiple different allele pairs have a similar and additive effect on a gene trait.

To demonstrate polygenic inheritance, let's suppose that the skin color trait is affected by three gene pairs - A, B and C.

Aa Bb Cc

Allele pair #1 Allele pair #2 Allele pair #3

The capital letters represent completely dominant genes that express dark skin while the lowercase letters represent genes that express light skin.

Since each gene has an additive effect on skin color, the more capital letters there are, the darker the skin is.

AA BB CC = Darkest Skin

a a b b c c = Lightest Skin

A Punnett square for the cross AaBbCc x AaBbCc is shown, with columns and rows labeled with all possible combinations of alleles (ABC, ABc, AbC, Abc, aBC, aBc, abC, abc). The resulting phenotypic classes are listed in a table below the Punnett square, ranging from 1 to 27.

A YouTube element has been excluded from this version of the text. You can view it online here:

<https://open.genetics.pressbooks.tru.ca/?p=864>

Media Attributions

- **Figure 8.4.1** [Original](#) by Deyholos (2017), [CC BY-NC 3.0](#), Open Genetics Lectures
- **Figure 8.4.2** [Original](#) by Deyholos (2017), [CC BY-NC 3.0](#), Open Genetics Lectures

References

AK Lectures (2015, January 12). Polygenic inheritance (video file). YouTube. <https://www.youtube.com/watch?v=tKnOvPtwZL4>

Deyholos, M. (2017). Figures: 15. Punnett Squares for one, two, or three loci; and 16. The more loci that affect a trait... [digital images]. In Locke, J., Harrington, M., Canham, L. and Min Ku Kang (Eds.), *Open Genetics Lectures, Fall 2017* (Chapter 26, p. 8). Dataverse/ BCcampus. http://solr.bccampus.ca:8001/bcc/file/7a7b00f9-fb56-4c49-81a9-cfa3ad80e6d8/1/OpenGeneticsLectures_Fall2017.pdf

Long Descriptions

- **Figure 8.4.1** Punnett Squares for One, Two, or Three Loci. This is a simplified example of up to three semi-dominant genes, and in each case the effect on the phenotype is additive, meaning the more “upper case” alleles present, the stronger the phenotype. A comparison of the Punnett squares and the associated phenotypes shows that, under these conditions, the larger the number of genes that affect a trait, the more intermediate phenotypic classes will be expected. [Back to [Figure 8.4.1](#)]
- **Figure 8.4.2** Bar charts and bell curves demonstrate that the more loci that are affecting a trait, the larger the number of phenotypic classes can be expected. For some traits, the number of contributing loci is so large that the phenotypic classes blend together in apparently continuous variation. [Back to [Figure 8.4.2](#)]

8.5 Environmental Factors

The phenotypes described thus far, have a nearly perfect correlation with their associated genotypes. In other words, an individual with a particular genotype always has the expected phenotype. However, most phenotypes are not determined entirely by genotype alone. Instead, they are determined by an interaction between genotype and environmental factors, and can be conceptualized in the following relationship:

Genotype + Environment

= Phenotype (G + E = P)

Or:

Genotype + Environment + InteractionGE

= Phenotype (G + E + IGE = P)

***GE = Genetics and Environment**

This interaction is especially relevant in the study of economically important phenotypes, such as human diseases or agricultural productivity. For example, a particular genotype may pre-dispose an individual to cancer, but cancer may only develop if the individual is exposed to certain DNA-damaging chemicals or carcinogens. Therefore, not all individuals with the particular genotype will develop the cancer phenotype, only those who experience a particular environment. The terms penetrance and expressivity are also useful to describe the relationship between certain genotypes and their phenotypes.

Penetrance

Penetrance is the proportion of individuals with a particular genotype that display a corresponding phenotype (**Figure 8.5.1**). It is usually expressed as a percentage of the population. Because all pea plants are homozygous for the allele for white flowers, this genotype is completely (100%) penetrant. In contrast, many human genetic diseases are incompletely penetrant, since not all individuals with the disease genotype develop symptoms associated with the disease (less than 100%).

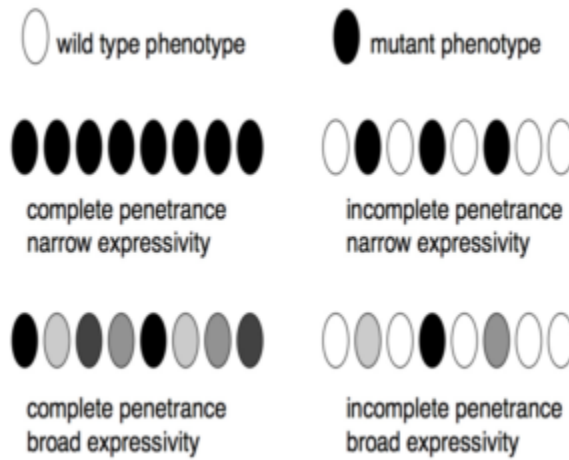

Figure 8.5.1 Relationship Between Penetrance and Expressivity in Eight Individuals With a Mutant Genotype. Penetrance can be complete (all eight have the mutant phenotype) or incomplete (only some have the mutant phenotype). Among those individuals with the mutant phenotype, the expressivity can be narrow (very little variation) to broad (lots of variation). [[Long description](#)]

Expressivity

Expressivity describes the variability in mutant phenotypes observed in individuals with a particular phenotype (**Figure 8.5.1** and **Figure 8.5.2**). Many human genetic diseases provide examples of broad expressivity, since individuals with the same genotypes may vary greatly in the severity of their symptoms. Incomplete penetrance and broad expressivity are due to random chance, non-genetic (environmental), and genetic factors (mutations in other genes).

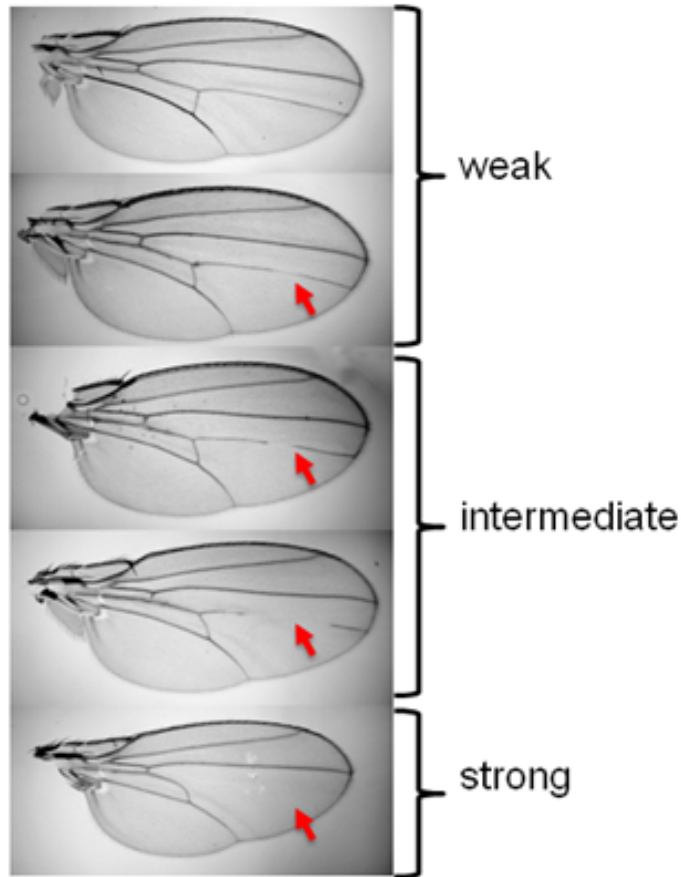
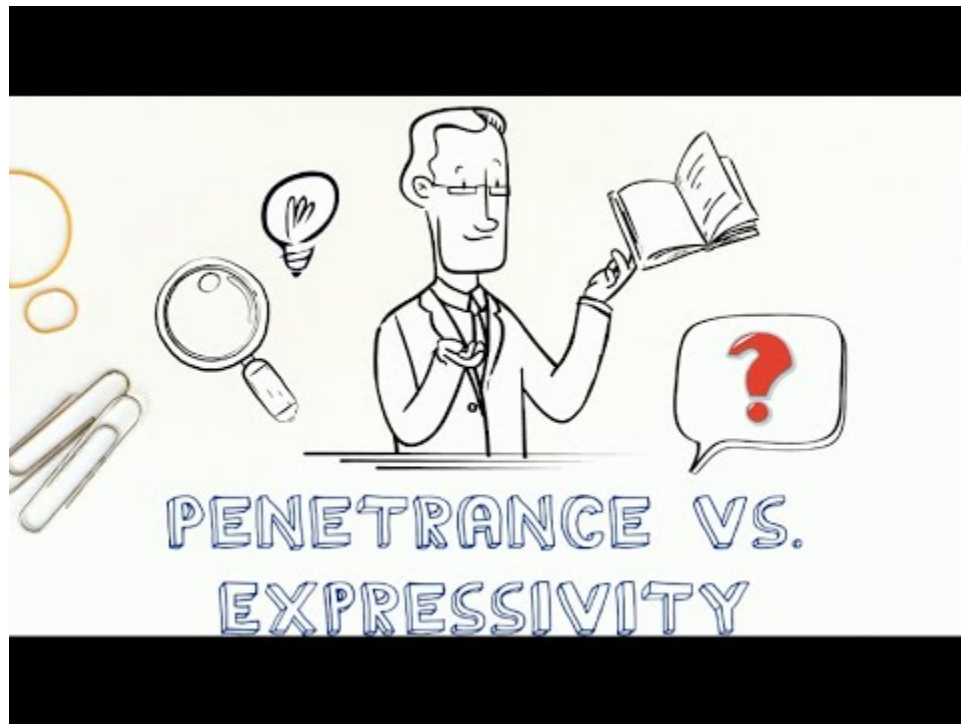

Figure 8.5.2 Mutations in Wings of *Drosophila Melanogaster* Show Weak to Strong Expressivity [[Long description](#)]

The video, *Penetrance vs. Expressivity*, by The Excel Cycle (2020) on YouTube, discusses the difference between expressivity and penetrance.



A YouTube element has been excluded from this version of the text. You can view it online here:

<https://opengenetics.pressbooks.tru.ca/?p=874>

Media Attributions

- **Figure 8.5.1 Original** by Locke (2017), [CC BY-NC 3.0](#), Open Genetics Lectures
- **Figure 8.5.2 Original** by Locke (2017), [CC BY-SA](#), Open Genetics Lectures

Reference

Locke, J. (2017). Figures: 18. Relationship between penetrance and expressivity; and 19. Mutations in wings of *Drosophila melanogaster*... [digital images]. In Locke, J., Harrington, M., Canham, L. and Min Ku Kang (Eds.), *Open Genetics Lectures, Fall 2017* (Chapter 26, p. 11). Dataverse/ BCcampus. http://solr.bccampus.ca:8001/bcc/file/7a7b00f9-fb56-4c49-81a9-cfa3ad80e6d8/1/OpenGeneticsLectures_Fall2017.pdf

The Excel Cycle. (2020, June 5). Penetrance vs. expressivity (video file). YouTube. <https://www.youtube.com/watch?v=nurrFUIDBHc>

Long Descriptions

- **Figure 8.5.1** Relationship between penetrance and expressivity in eight individuals with a mutant genotype. Penetrance can be complete (all eight have the mutant phenotype) or incomplete (only some have the mutant phenotype). Among those individuals with the mutant phenotype, the expressivity can be narrow (very little variation) to broad (lots of variation). [Back to [Figure 8.5.1](#)]
- **Figure 8.5.2** Five different mutations demonstrated in the wings of *Drosophila* show weak to strong expressivity, which describes the variability in mutant phenotypes observed in individuals with a particular phenotype, which can be due to random chance, environment and/or other genetic factors. [Back to [Figure 8.5.2](#)]

8.6 Factors Causing Deviation from Mendelian Phenotypic Ratios

There are other factors that affect an organism's phenotype and thus appear to alter Mendelian inheritance.

1. **Genetic heterogeneity:** There is more than one gene or genetic mechanism that can produce the same phenotype.
2. **Polygenic determination:** One phenotypic trait is controlled by multiple genes.
3. **Phenocopy:** Organisms that do not have the genotype for trait A can also express trait A due to environmental conditions; they do not have the same genotype but the environment simply “copies” the genetic phenotype.
4. **Incomplete penetrance:** even though an organism possesses the genotype for trait A, it might not be expressed with 100% effect.
5. Certain genotypes show a survival rate that is less than 100%. For example, genotypes that cause death, **recessive lethal mutations**, at the embryo or larval stage will be underrepresented when adult flies are counted.

The video, *Extension of Mendelism – Phenocopy, Incomplete Penetrance, Expressivity (BI_08)*, by Biology Insights (2020) on YouTube, discusses various extensions of Mendelism, including phenocopy and incomplete penetrance.

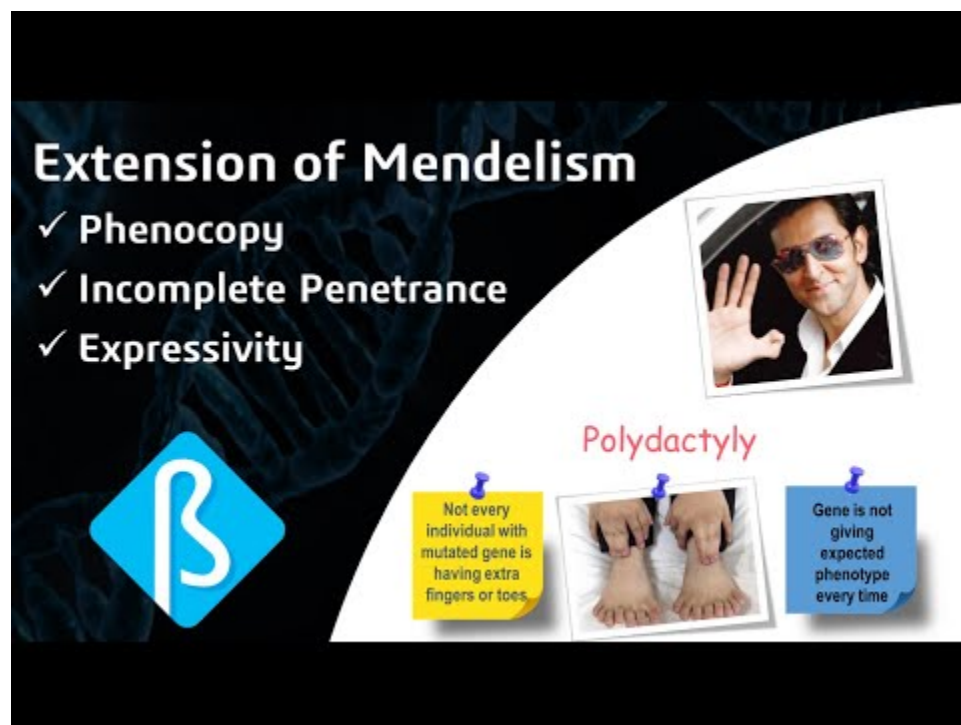

A YouTube element has been excluded from this version of the text. You can view it online here:

<https://opengenetics.pressbooks.tru.ca/?p=881>

Reference

Biology Insights. (2020, July 29). Extension of Mendelism – Phenocopy, incomplete penetrance, expressivity (BI_08) (video file). YouTube. <https://www.youtube.com/watch?v=m9Dv3gS73d8>

Chapter 8 Summary

The topics covered in this chapter can be summarized as follows:

- Phenotypes depends on the alleles that are present, their dominance relationships, and sometimes also interactions with the environment and other factors.
- The alleles of different loci are inherited independently of each other, unless they are genetically linked.
- Many important traits show continuous, rather than discrete variation. These are called quantitative traits.
- Many quantitative traits are influenced by a combination of environment and genetics.
- The expected phenotypic ratio of a dihybrid cross is 9:3:3:1, except in cases of linkage or gene interactions that modify this ratio.
- Modified ratios from 9:3:3:1 are seen in the case of recessive and dominant epistasis, duplicate genes, and complementary gene action. This usually indicates that the two genes interact within the same biological pathway.
- There are other factors that alter the expected Mendelian ratios.

Key Terms in Chapter 8

Key Terms – Gene Interactions

- Complementary Action
- Continuous variation
- dihybrid
- Dominant Epistasis
- Duplicate Gene Action
- expressivity
- $G + E = P$
- independent assortment
- linkage
- Mendel's Second Law
- Modified Mendelian Ratios
- penetrance
- Polygenic traits
- Recessive Epistasis
- recessive lethal mutations
- Redundancy

Chapter 8 Study Questions

1. In the table below, match the mouse hair color phenotypes with the term from the list that best explains the observed phenotype, given the genotypes shown. In this case, the allele symbols do not imply anything about the dominance relationships between the alleles. **List of terms:** haplosufficiency, haploinsufficiency, pleiotropy, incomplete dominance, co-dominance, incomplete penetrance, broad (variable) expressivity.

	A1A1	A1A2	A2A2
1	all hairs black	on the same individual: 50% of hairs are all black and 50% of hairs are all white	all hairs white
2	all hairs black	all hairs are the same shade of grey	all hairs white
3	all hairs black	all hairs black	50% of individuals have all white hairs and 50% of individuals have all black hairs
4	all hairs black	all hairs black	mice have no hair
5	all hairs black	all hairs white	all hairs white
6	all hairs black	all hairs black	all hairs white
7	all hairs black	all hairs black	hairs are a wide range of shades of grey

Answer questions 2–4 using the following biochemical pathway for fruit color. Assume all mutations (lower case allele symbols) are recessive, and that either precursor 1 or precursor 2 can be used to produce precursor 3. If the alleles for a particular gene are not listed in a genotype, assume that they are wild-type.

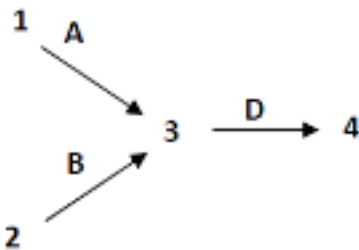

2. If 1 and 2 and 3 are all colorless, and 4 is red, what will be the phenotypes associated with the following genotypes?
- aa
 - bb
 - dd
 - aabb
 - aadd
 - bbdd
 - aabbdd
 - What will be the phenotypic ratios among the offspring of a cross $AaBb \times AaBb$?
 - What will be the phenotypic ratios among the offspring of a cross $BbDd \times BbDd$?

- j. What will be the phenotypic ratios among the offspring of a cross $AaDd \times AaDd$?
3. If 1 and 2 are both colorless, and 3 is blue and 4 is red, what will be the phenotypes associated with the following genotypes?
- aa
 - bb
 - dd
 - aabb
 - aadd
 - bbdd
 - aabbdd
- h. What will be the phenotypic ratios among the offspring of a cross $AaBb \times AaBb$?
- i. What will be the phenotypic ratios among the offspring of a cross $BbDd \times BbDd$?
- j. What will be the phenotypic ratios among the offspring of a cross $AaDd \times AaDd$?
4. If 1 is colorless, 2 is yellow and 3 is blue and 4 is red, what will be the phenotypes associated with the following genotypes?
- aa
 - bb
 - dd
 - aabb
 - aadd
 - bbdd
 - aabbdd
- h. What will be the phenotypic ratios among the offspring of a cross $AaBb \times AaBb$?
- i. What will be the phenotypic ratios among the offspring of a cross $BbDd \times BbDd$?
- j. What will be the phenotypic ratios among the offspring of a cross $AaDd \times AaDd$?
5. Which of the situations in questions 2 – 4 demonstrate epistasis?
6. If the genotypes written within the Punnett Square are from the F_2 generation, what would be the phenotypes and genotypes of the F_1 and P generations for:
- Figure 8.3.2
 - Figure 8.3.4
 - Figure 8.3.6
 - Figure 8.3.8
7. To better understand how genes can control the development of three-dimensional structures, you conducted a mutant screen in Arabidopsis plant and identified a recessive point mutation allele of a single gene (g) that causes leaves to develop as narrow tubes rather than the broad flat surfaces that develop in wild-type (G). Allele g causes a complete loss of function. Now you want to identify more genes involved in the same process. Diagram a process you could use to identify other genes that interact with gene g . Show all the possible genotypes that could arise in the F_1 generation.
8. With reference to question 7, if the recessive allele, g is mutated again to make allele g^* , what are the possible phenotypes of a homozygous g^*g^* individual?
9. Again, in reference to question 8, what are the possible phenotypes of a homozygous $aagg$ individual, where a is a recessive allele of a second gene? In each case, also specify the phenotypic ratios that would be observed among the F_1 progeny of a cross of $AaGg \times AaGg$.
10. Use the product rule to calculate the phenotypic ratios expected from a trihybrid cross. Assume independent assortment and no epistasis/gene interactions.

Chapter 8 Answers

1.
 - i. case 1 – co-dominance
 - ii. case 2 – incomplete-dominance (partial-dominance)
 - iii. case 3 – incomplete penetrance
 - iv. case 4 – pleiotropy
 - v. case 5 – haplo-sufficiency of the A2 allele for white phenotype
 - vi. case 6 – haplo-insufficiency of the A2 allele for white phenotype
 - vii. case 7 – broad (variable) expressivity of A2 allele
2. If 1 and 2 and 3 are all colorless, and 4 is red, what will be the phenotypes associated with the following genotypes? All of these mutations are recessive. As always, if the genotype for a particular gene is not listed, you can assume that alleles for that gene are wild-type.
 - a. red (because A and B are redundant, so products 3 and then 4 can be made)
 - b. red (because A and B are redundant, so products 3 and then 4 can be made)
 - c. white (because product 3 will accumulate and it is colorless)
 - d. white (because only product 1 and 2 will be present and both are colorless)
 - e. white (because only product 1 and 3 will be present and both are colorless)
 - f. white (because only product 2 and 3 will be present and both are colorless)
 - g. white (because only product 1 and 2 will be present and both are colorless)
 - h. 15 red : 1 white

	AB	Ab	aB	ab
AB	AABB	AABb	AaBB	AaBb
Ab	AABb	AAbb	AaBb	Aabb
aB	AaBB	AaBb	aaBB	aaBb
ab	AaBb	Aabb	aaBb	aabb

- i. 12 red: 4 white

	BD	Bd	bD	bd
BD	BBDD	BBDd	BbDD	BbDd
Bd	BBdD	BBdd	BbDd	Bbdd
bD	BbDD	BbDd	bbDD	bbDd
bd	BbDd	Bbdd	bbDd	bbdd

- j. 12 red: 4 white

	AD	Ad	aD	ad
AD	AADD	AADd	AaDD	AaDd
Ad	AADd	AAdd	AaDd	Aadd
aD	AaDD	AaDd	aaDD	aaDd
ad	AaDd	Aadd	aaDd	aadd

3.
 - a. red (because A and B are redundant, so products 3 and then 4 can be made)
 - b. red (because A and B are redundant, so products 3 and then 4 can be made)

- c. blue (because product 3 will accumulate, and it is blue)
- d. white (because only product 1 and 2 will be present and both are colorless)
- e. blue (because only product 1 and 3 will be present and 1 is colorless and 3 is blue)
- f. blue (because only product 2 and 3 will be present and 2 is colorless and 3 is blue)
- g. white (because only product 1 and 2 will be present and both are colorless)
- h. 15 red : 1 white

	AB	Ab	aB	ab
AB	AABB	AABb	AaBB	AaBb
Ab	AABb	AAbb	AaBb	Aabb
aB	AaBB	AaBb	aaBB	aaBb
ab	AaBb	Aabb	aaBb	aabb

- i. 12 red : 4 blue

	BD	Bd	bD	bd
BD	BBDD	BBdD	BbDD	BbDd
Bd	BBdD	BBdd	BbDd	Bbdd
bD	BbDD	BbDd	bbDD	bbDd
bd	BbDd	Bbdd	bbDd	bbdd

- j. 12 red : 4 blue

	AD	Ad	aD	ad
AD	AADD	AADd	AaDD	AaDd
Ad	AADd	AAdd	AaDd	Aadd
aD	AaDD	AaDd	aaDD	aaDd
ad	AaDd	Aadd	aaDd	aadd

- 4.
 - a. red (because A and B are redundant, so products 3 and then 4 can be made)
 - b. red (because A and B are redundant, so products 3 and then 4 can be made)
 - c. blue (because product 3 will accumulate, and it is blue)
 - d. yellow (because only product 1 and 2 will be present and 1 is colorless and 2 is yellow)
 - e. blue (because only product 1 and 3 will be present and 1 is colorless and 3 is blue)
 - f. green? (because only product 2 and 3 will be present and 2 is yellow and 3 is blue, so probably the fruit will be some combination of those two colors)
 - g. yellow (because only product 1 and 2 will be present and 1 is colorless and 2 is yellow)
 - h. 15 red: 1 yellow

	AB	Ab	aB	ab
AB	AABB	AABb	AaBB	AaBb
Ab	AABb	AAbb	AaBb	Aabb
aB	AaBB	AaBb	aaBB	aaBb
ab	AaBb	Aabb	aaBb	aabb

- i. 12 red: 3 blue: 1 green

	BD	Bd	bD	bd
BD	BBDD	BBdD	BbDD	BbDd
Bd	BBdD	BBdd	BbDd	Bbdd
bD	BbDD	BbDd	bbDD	bbDd
bd	BbDd	Bbdd	bbDd	bbdd

j. 12 red: 4 blue

	AD	Ad	aD	ad
AD	AADD	AADd	AaDD	AaDd
Ad	AADd	AAdd	AaDd	Aadd
aD	AaDD	AaDd	aaDD	aaDd
ad	AaDd	Aadd	aaDd	aadd

5. Epistasis is demonstrated when the phenotype for a mutant in one locus is prevented from being expressed by a mutant at another locus. In this case, we would expect a homozygous mutant at one locus (e.g., D) to be the same phenotype as a homozygous mutant in both loci (e.g., D and A, or D and B). So, the following situations from questions 2-4 demonstrated epistasis:

Q#2: No epistasis can be determined from the phenotypes (even though we know from the pathway provided that D is downstream of A and B). There are only two possible phenotypes. So even though the D locus might be epistatic to A and B, one cannot see this interaction because the product of both A and B (compound 3) is colourless.

Q#3: The phenotypes show that D is epistatic to A and B:

- *aadd* looks like *AAdd* or *Aadd*; *dd* prevents the expression of the A or a alleles.
- *bbdd* looks like *BBdd* or *Bbdd*; *dd* prevents the expression of the B or b alleles.

Note: that the triple mutant *aabbdd* would be colourless (white).

Q#4: The phenotypes show that D is epistatic to A, because *aadd* looks like *AAdd* or *Aadd*.

With *bbdd*, the difference between *bbdd* (green), *Bbdd* (blue), and *BBdd* (blue) is apparent. Thus, the phenotypes do not provide evidence for epistasis between B and D.

6. The answer is the same for **a→d**

- P could have been either: **AABB × aabb** or **aaBB × AAbb**;
- F1 was: **AaBb × AaBb**
- Conduct an enhancer/suppressor screen (which can also result in the identification of revertants, as well)

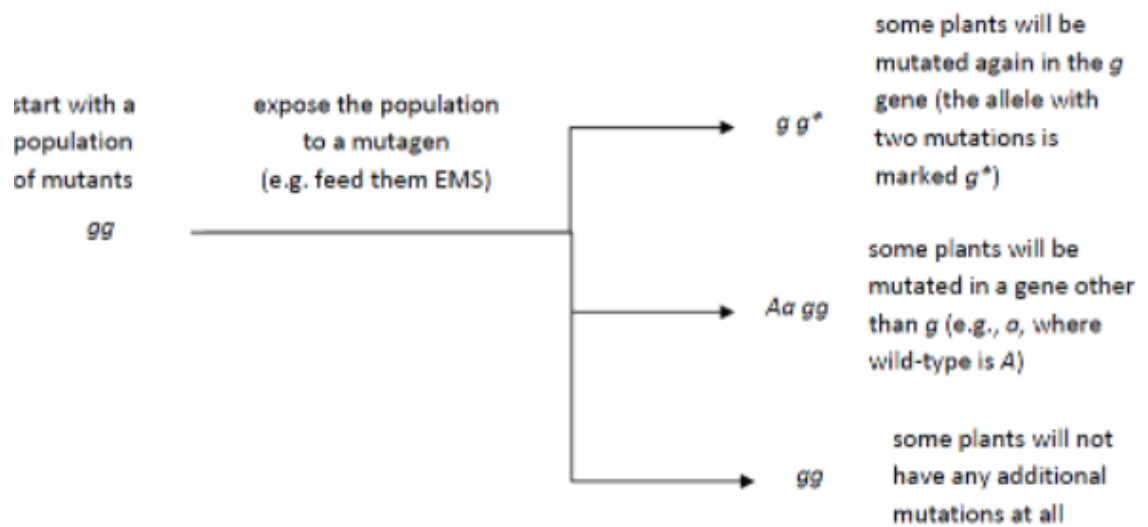

Allow the plants to self-pollinate in order to make any new, recessive mutations homozygous.

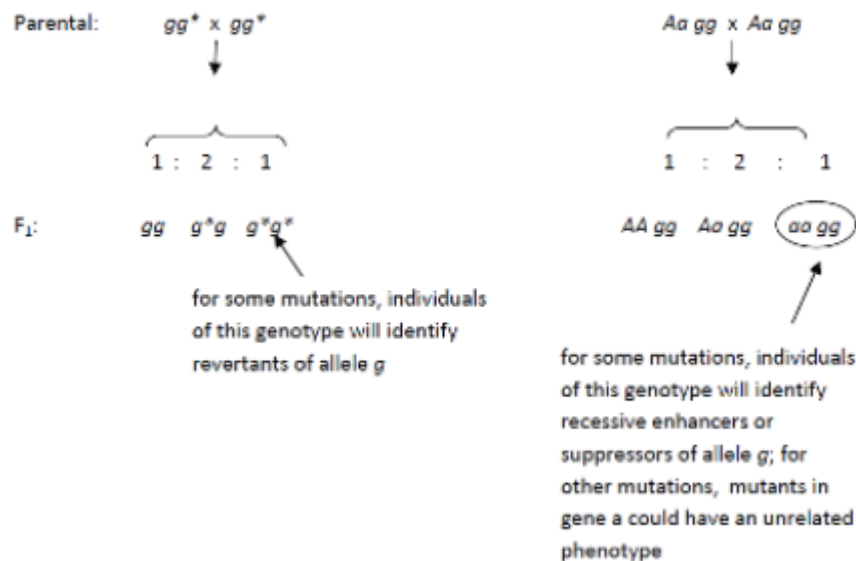

- Depending on which amino acids were altered, and how they were altered, a second mutation in g^*g^* could either have no effect (in which case the phenotype would be the same as gg), or it could possibly cause a reversion of the phenotype to wild-type, so that g^*g^* and GG have the same phenotype.
- Depending on the normal function of gene A , and which amino acids were altered in allele a , there are many potential phenotypes for $aagg$.

Case 1: If the normal function of gene A is in an unrelated process (e.g., A is required for root development, but not the development of leaves), then the phenotype of $aagg$ will be: short roots and narrow leaves. The phenotypic ratios among the progeny of a dihybrid cross will be:

9	3	3	1
$A_G_$	A_gg	$aaG_$	$aagg$
wild-type	tubular leaves normal roots	short roots normal leaves	tubular leaves short roots

Case 2: If the normal function of gene A is in the same process as G , such that a is a recessive allele that

increases the severity of the *gg* mutant (**i.e., *a* is an enhancer of *g***) then the phenotype of *aagg* could be : no leaves. The phenotypic ratios among the progeny of a dihybrid cross depend on whether *aa* mutants have a phenotype independent of *gg*, in other words, do *aaG_* plants have a phenotype that is different from wild-type or from *A_gg*. There is no way to know this without doing the experiment, since it depends on the biology of the particular gene, mutation and pathway involved.

The following (2a, 2b, 2c) are the three possible outcomes:

Case 2a) If *aa* is an enhancer of *gg*, and *aaG_* plants have a mutant phenotype that differs from wild-type or (*A_gg*) then the phenotypic ratios among the progeny of a dihybrid cross will be:

9	3	3	1
<i>A_G_</i>	<i>A_gg</i>	<i>aaG_</i>	<i>aagg</i>
wild-type	tubular leaves (some phenotype that differs from <i>gg</i> ; maybe small twisted leaves)	abnormal leaves	no leaves

Case 2b) If *aa* is an enhancer of *gg*, and *aaG_* plants have a mutant phenotype that is the same as *A_gg*, the phenotypic ratios among the progeny of a dihybrid cross will be:

9	6	1
<i>A_G_</i>	<i>A_gg</i> <i>aaG_</i>	<i>aagg</i>
wild-type	tubular leaves	no leaves

Case 2c) If *aa* is an enhancer of *gg*, and *aaG_* do not have a phenotype that differs from wild-type then the phenotypic ratios among the progeny of a dihybrid cross will be:

12	3	1
<i>A_G_ aaG_</i>	<i>A_gg</i>	<i>aagg</i>
wild-type	tubular leaves	no leaves

Case 3: If the normal function of gene A is in the same process as G, such that *a* is a recessive allele that **decreases** the severity of the *gg* mutant (**i.e., *a* is an suppressor of *g***) then the phenotype of *aagg* could be: wild-type. The phenotypic ratios among the progeny of a dihybrid cross depend on whether *aa* mutants have a phenotype independent of *gg*, in other words, do *aaG_* plants have a phenotype that is different from wild-type or from *A_gg*. There is no way to know this without doing the experiment, since it depends on the biology of the particular gene, mutation and pathway involved.

The following (3a, 3b, 3c) are the three possible outcomes:

Case 3 a) If *aa* is a suppressor of *gg*, and *aaG_* plants have a mutant phenotype that differs from wild-type or (*A_gg*) then the phenotypic ratios among the progeny of a dihybrid cross will be:

10	3	3
<i>A_G_ aagg</i>	<i>A_gg</i>	<i>aaG_</i>
wild-type	tubular leaves (some phenotype that differs from <i>gg</i>)	no leaves

Case 3 b) If *aa* is an suppressor of *gg*, and *aaG_* plants have a mutant phenotype that is the same as *A_gg* the phenotypic ratios among the progeny of a dihybrid cross will be:

10	6
A_G_ aagg	A_gg aaG_
wild-type	tubular leaves

Case 3 c) If *aa* is an suppressor of *gg*, and *aaG_* plants do not have a phenotype that differs from wild-type then the phenotypic ratios among the progeny of a dihybrid cross will be:

13	3
A_G_ aaG_ aagg	A_gg
wild-type	tubular leaves

Case 4: If the normal function of gene A is in the same process as G, such that *a* is a recessive allele that with a phenotype that **is epistatic** to the *gg* mutant then the phenotype of both *aaG_* and *aagg* could be : no leaves. The phenotypic ratios among the progeny of a dihybrid cross will be:

9	4	3
A_G_	aaG_ aagg	A_gg
wild-type	no leaves	tubular leaves

- Closing Statement:** There are many more phenotypes and ratios that could be imagined (e.g., different types of dominance relationships, different types of epistasis, lethality...etc). Isn't genetics wonderful? It is sometimes shocking that more people don't want to become geneticists.
- The point of this exercise is to show that many different ratios can be generated, depending on the biology of the genes involved. On an exam, you could be asked to calculate the ratio, given particular biological parameters. So, this exercise is also meant to demonstrate that it is better to learn how to calculate ratios than just trying to memorize which ratios match which parameters. In a real genetic screen, you would observe the ratios, and then try to deduce something about the biology from those ratios.
- For a dihybrid cross, there are 4 classes, 9:3:3:1. In a trihybrid cross without gene interactions, each of these 4 classes will be further split into a 3:1 ratio based on the phenotype at the third locus. For example, $9 \times 3 = 27$ and $9 \times 1 = 9$. This explains the first two terms of the complete ratio: 27:9:9:3:3:3:1.

CHAPTER 9 - LINKAGE AND RECOMBINATION FREQUENCY

9.1 Introduction

Learning Objectives

- Describe what is meant by genetic recombination and relate it to specific stages of meiosis.
- Identify and use specific notation related to linked genes including the *cis* and *trans* configurations.
- Compare recombination frequencies between completely linked genes vs. those which assort independently.
- Calculate recombination frequency given experimental data.

As we have already discussed, Mendel reported that the pairs of loci he observed segregated independently of each other; for example, the segregation of seed color alleles was independent of the segregation of alleles for seed shape. This observation was the basis for his Second Law (Independent Assortment), and contributed greatly to our understanding of heredity as single units. However, further research showed that Mendel's Second Law did not apply to every pair of genes that could be studied. In fact, we now know that alleles of loci located close together on the same chromosome tend to be inherited together. This phenomenon is called **linkage**, and is a major exception to Mendel's **Second Law of Independent Assortment**.

Unlinked genes are on different chromosomes or far apart on the same chromosome, while linked genes are close (enough) together on the same chromosome. The random assortment of the different alleles of genes on different chromosomes depends upon the segregation and independent assortment of the chromosomes during meiosis I. However, genetic recombination of different alleles of genes on the same chromosome can only occur by crossing over. When genes are located physically very near to each other on a particular chromosome, they act as if they are *linked* and inherited *together*.

Watch this video, *Genetic Linkage*, by Steve Baskauf (2015) on YouTube.

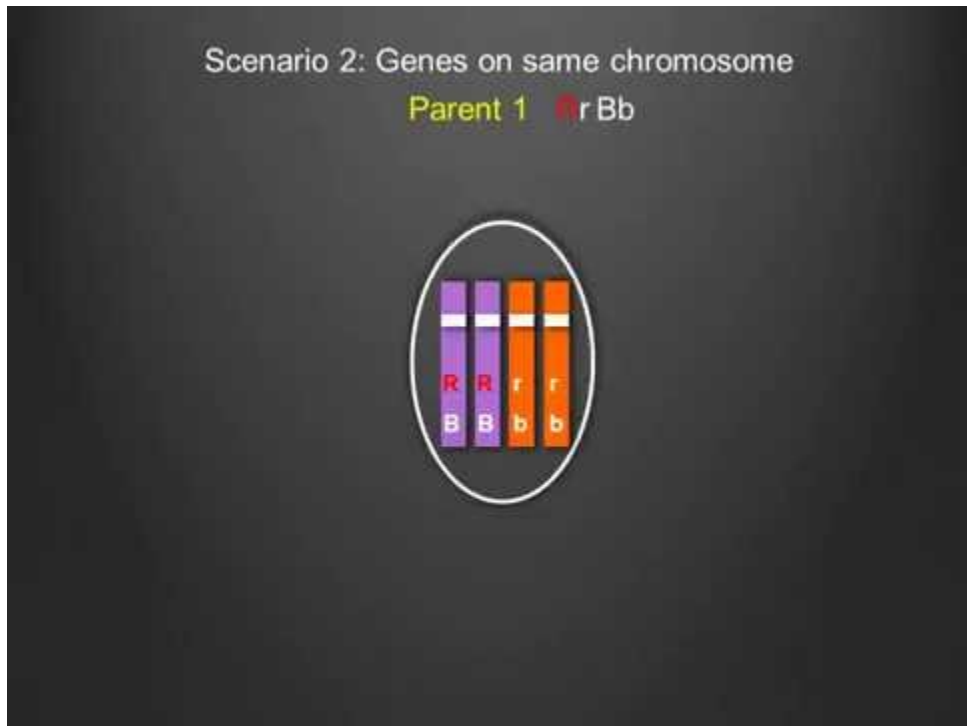

A YouTube element has been excluded from this version of the text. You can view it online here:

<https://opengenetics.pressbooks.tru.ca/?p=922>

Researchers use linkage to determine the location of genes along chromosomes in a process called genetic mapping. The concept of gene linkage is important to the natural processes of heredity and evolution, as well as our genetic manipulation of crops and livestock.



Figure 9.1.1 The Coat Colour on This Juvenile Horse is Called “Bay Roan Tobiano.” Bay is the brown base coat colour; Roan is the mixture of white hairs with the base coat, making a ‘foggy’ colour; and Tobiano is the white patches. The genes causing the Roan and Tobiano coat colours, respectfully, are found on the same chromosome and linked. Knowing this, we can predict which coat colour genes are from which parents, and how those genes will be inherited in this horse’s offspring. [[Long description](#)]

Media Attribution

- **Figure 9.1.1** [Roan tobiano](#) by Kumana @ Wild Equines, [CC BY 2.0](#), via Wikimedia Commons

Reference

Steve Baskauf, S. (2015, February 16). Genetic linkage (video file). YouTube. <https://www.youtube.com/watch?v=iH8b-5BxtuY>

Long Description

- **Figure 9.1.1** A juvenile horse with a coat colour called “Bay Roan Tobiano.” Bay is the brown base coat colour; Roan is the mixture of white hairs with the base coat, making a ‘foggy’ colour; and Tobiano is the white patches. The genes causing the roan and tobiano coat colours, respectfully, are found on the same chromosome and linked. Knowing this, we can predict which coat colour genes are from which parents, and how those genes will be inherited in this horse’s offspring. [Back to [Figure 9.1.1](#)]

9.2 Review of Genetic Nomenclature and Symbols

A **gene** is a hereditary unit that occupies a specific position (**locus**) within the genome or chromosome and has one or more specific effects upon the phenotype of the organism and can mutate into various forms (**alleles**). A **genotype** is the specific allelic composition of a cell or organism. Normally, only the genes under consideration are listed in a genotype, while the alleles at the remaining gene loci are considered to be wild type. A **phenotype** is the detectable outward manifestation of a specific genotype. In describing a phenotype, usually only the characteristics under consideration are listed while the remaining characters are assumed to be wild type (normal).

Gene Names and Symbols

Usually, gene names are unique and their corresponding symbols are unique letters or combinations of letters. So, for example, the “*vermillion*” gene in *Drosophila* is represented by the letter “*v*”, while “*vg*” is the symbol for the “*vestigial*” gene and “*vgl*” is the symbol for the “*ventral veins lacking*” gene locus. Note, however, that the same letter symbols may represent a different gene in another organism. Gene symbols and gene names are typically shown *italicized* text, but not always.

The normal, or wild type, form of a gene is usually symbolized by superscript plus sign, “+”. E.g., “ a^+ ”, “ b^+ ”, etc. or it is sometimes abbreviated to just “+”. A forward slash is occasionally used to indicate that the two symbols are alleles of the same gene, but on homologous chromosomes.

A typical mutant form of the gene, of which there can be many, can be symbolized by a superscript minus sign, “-”. E.g., “ a^- ”, “ b^- ”, etc., or sometimes abbreviated to just “ a^- ”, “ b^- ”, etc. (no superscript). Therefore, if the genotype of a diploid organism is given as a^+/a^- , it means there is a wild type allele and mutant allele of the “*a*” gene at the “*a*” locus. This may also be abbreviated to $+/a$.

In some species of diploids, the dominant allele is typically designated with the uppercase letter(s), while the recessive allele is given the lowercase letter(s). For example, in Mendel’s peas the dominant Rough allele is “*R*”, while the recessive smooth alleles is “*r*”.

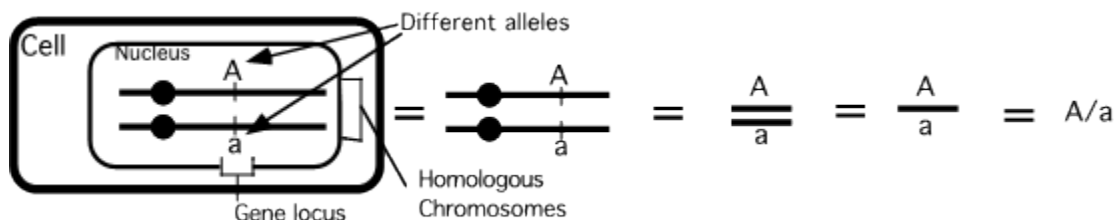

Figure 9.2.1 A Diagram Illustrating Chromosomes, Loci, and Alleles in a Cell, and How We Depict Them as Text
[\[Long description\]](#)

Media Attribution

- **Figure 9.2.1** [Original](#) by J. Locke (2017), [CC BY-NC 3.0](#), Open Genetics Lectures

Reference

Locke, J. (2017). Figure 2. A diagram illustrating how chromosomes, loci and alleles...[digital image]. In Locke, J., Harrington, M., Canham, L. and Min Ku Kang (Eds.), *Open Genetics Lectures, Fall 2017* (Chapter 18, p. 2). Dataverse/BCcampus. http://solr.bccampus.ca:8001/bcc/file/7a7b00f9-fb56-4c49-81a9-cfa3ad80e6d8/1/OpenGeneticsLectures_Fall2017.pdf

Long Description

- **Figure 9.2.1** Chromosomes, loci, and alleles in a cell are usually depicted by solid black lines, small black lines perpendicular to these solid lines, and letters (capital or lowercase) respectively. [Back to [Figure 9.2.1](#)]

9.3 Recombination and Recombination Frequency

The process of meiosis leading to a separation of chromosomes, as well as crossing over, is necessary for the understanding of the process of recombination.

The term “recombination” is used in several different contexts in genetics. In reference to heredity, **recombination** is defined as a process that results in gametes with combinations of alleles that were not present in the gametes from the parental generation (**Figure 9.3.1**). Recombination is important because it contributes to the genetic variation that may be observed between individuals within a population and that may be acted upon by selection for evolution.

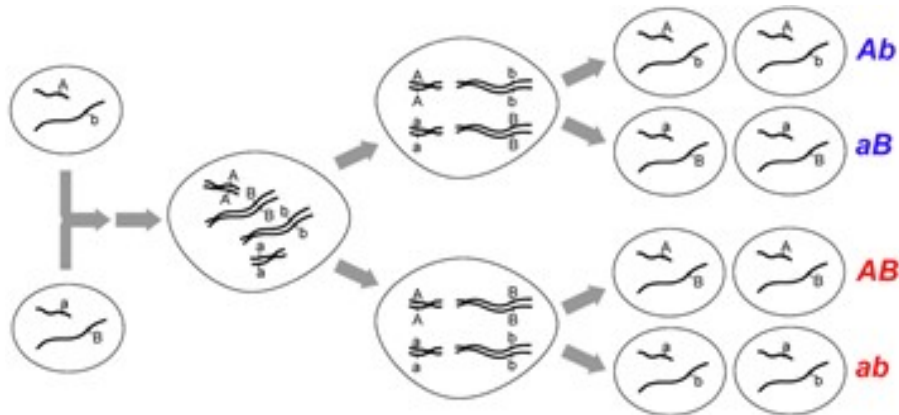
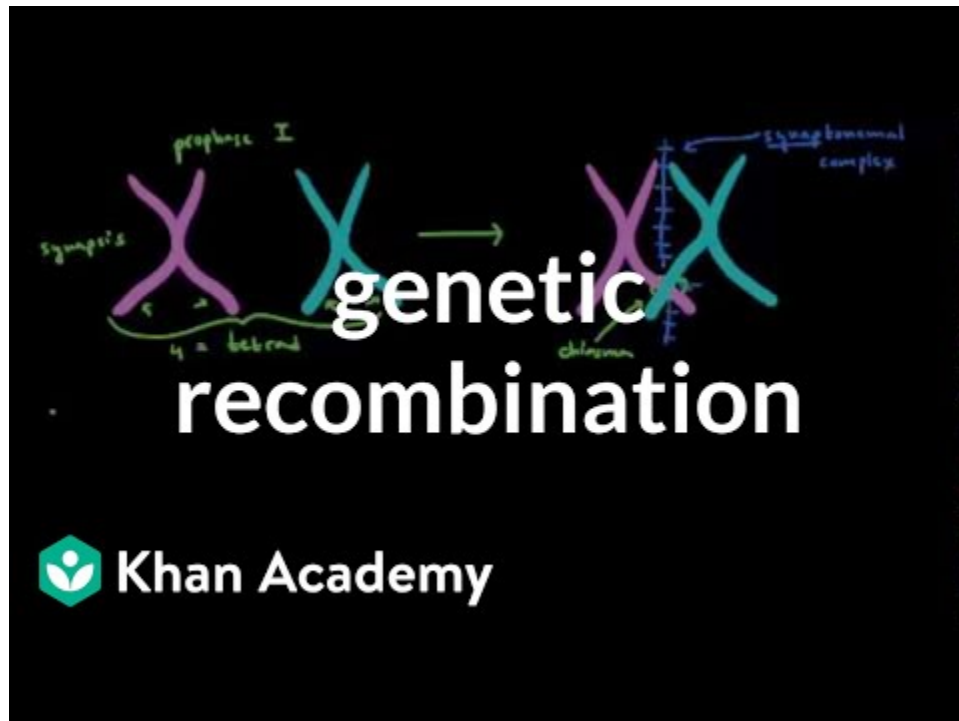

Figure 9.3.1 When Two Loci are on Non-Homologous Chromosomes, Their Alleles Will Segregate in Combinations Identical to Those Present in the Parental Gametes (Ab, aB), and in Recombinant Genotypes (AB, ab) that are Different from the Parental Gametes [[Long description](#)]

Watch video, [Genetic recombination 1 | Biomolecules | MCAT | Khan Academy Medicine](#), created by Efrat Bruck (2015) at Khan Academy on YouTube (<https://www.youtube.com/watch?v=BlnUNmfGn7I>).



A YouTube element has been excluded from this version of the text. You can view it online here:

<https://opengenetics.pressbooks.tru.ca/?p=935>

Inter- and Intrachromosomal Recombination

Interchromosomal recombination occurs either through **independent assortment** of alleles whose loci are on different chromosomes. **Intrachromosomal recombination** occurs through **crossovers** between loci on the same chromosomes. It is important to remember that in both of these cases, recombination is a process that occurs during meiosis (mitotic recombination may also occur in some species, but it is relatively rare).

As an example of interchromosomal recombination, consider loci on two different chromosomes as shown in **Figure 9.3.1**. We know that if these loci are on different chromosomes there is no physical connection between them, so they are **unlinked** and will segregate independently as did Mendel's traits. The segregation depends on the relative orientation of each pair of chromosomes at metaphase. Since the orientation is random and independent of other chromosomes, each of the arrangements (and their meiotic products) is equally possible for two unlinked loci as shown in **Figure 9.3.1**.

Intrachromosomal recombination occurs through crossovers. Crossovers occur during prophase I of meiosis, when pairs of homologous chromosomes have aligned with each other in a process called **synapsis**. Crossing over begins with the breakage of DNA of a pair of non-sister chromatids. The breaks occur at corresponding positions on two non-sister chromatids, and then the ends of non-sister chromatids are connected to each other resulting in a reciprocal exchange of double-stranded DNA. Generally, every pair of chromosomes has at least one crossover during meiosis, but often multiple crossovers occur in each chromatid during prophase I.

Because interchromosomal recombination occurs through independent assortment, genes in this situation are always unlinked. Intrachromosomal recombination has instances of linked genes, and so they will be the focus of this chapter.

Inheriting Parental and Recombinant Gametes

If we consider only two loci and the products of meiosis result in recombination, then the meiotic products (gametes) are said to have a **recombinant genotype**. On the other hand, if no recombination occurs between the two loci during meiosis, the products retain their original combinations and are said to have a non-recombinant, or **parental genotype**. The ability to properly identify parental and recombinant gametes is essential to apply recombination to experimental examples.

To properly identify recombinant and parental gametes from an individual, you need to know the genotype of its parents (the P generation). This is most easily demonstrated in a dihybrid. If, for two genes, one parent has the genotype $A/A B/B$, they can only produce one type of gamete: AB . Similarly, if they are $a/a b/b$, they can also only produce one type of gamete: ab (**Figure 9.3.2** right). However, if those two gametes (AB and ab) combine, they create an individual (F1) with a genotype written as $A/a B/b$. It can be easier to keep track of the parental combinations of gametes by keeping them together when writing the genotype, for this example AB/ab (**Figure 9.3.2**).

So, the above dihybrid individual can produce four different gametes: AB , ab , Ab and aB . The **parental gametes** are those that the individual obtained from their parents, in this case AB and ab . Ab and aB are **recombinant gametes** and are evidence of a recombination event happening, resulting in a different combination of alleles (**Figure 9.3.2** right).

For the above example, the P generation has one parent homozygous for both dominant alleles, and the other homozygous for both recessive alleles. It is important to note that this will not always be the case. In some instances, one parent will be homozygous, with one gene dominant and the other gene recessive ($A/A b/b$), and the other parent will be the opposite ($a/a B/B$). This situation will change, which is the parental and recombinant gametes (compare left and right in **Figure 9.3.2**).

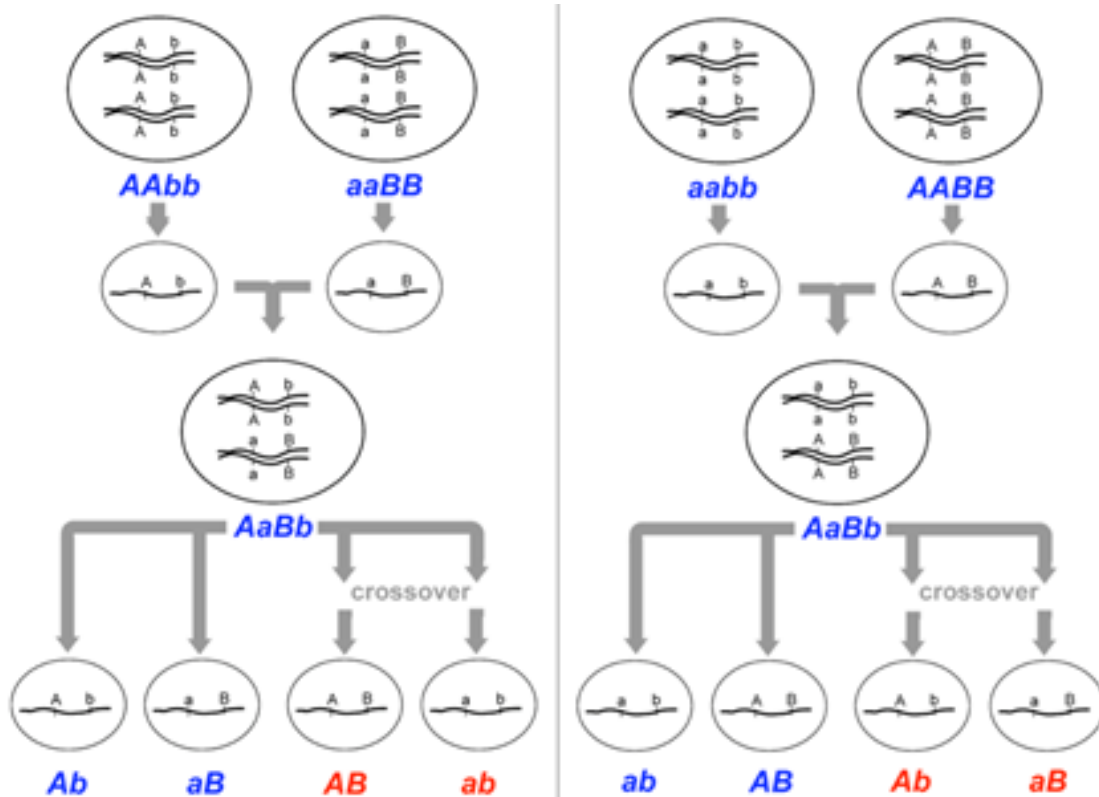

Figure 9.3.2 The Genotype of Gametes Can be Inferred Unambiguously if Homozygotes Produce the Gametes. However, recombination frequencies can only be measured among the progeny of heterozygotes (i.e., dihybrids). Note that the dihybrid on the left contains a different configuration of alleles than the dihybrid on the right, due to differences in the genotypes of their respective parents. Therefore, different gametes are defined as recombinant (red) and parental (blue) among the progeny of the two dihybrids. In the cross at left, the recombinant gametes will be genotype AB and ab, and in the cross on the right, the recombinant gametes will be Ab and aB. [[Long description](#)]

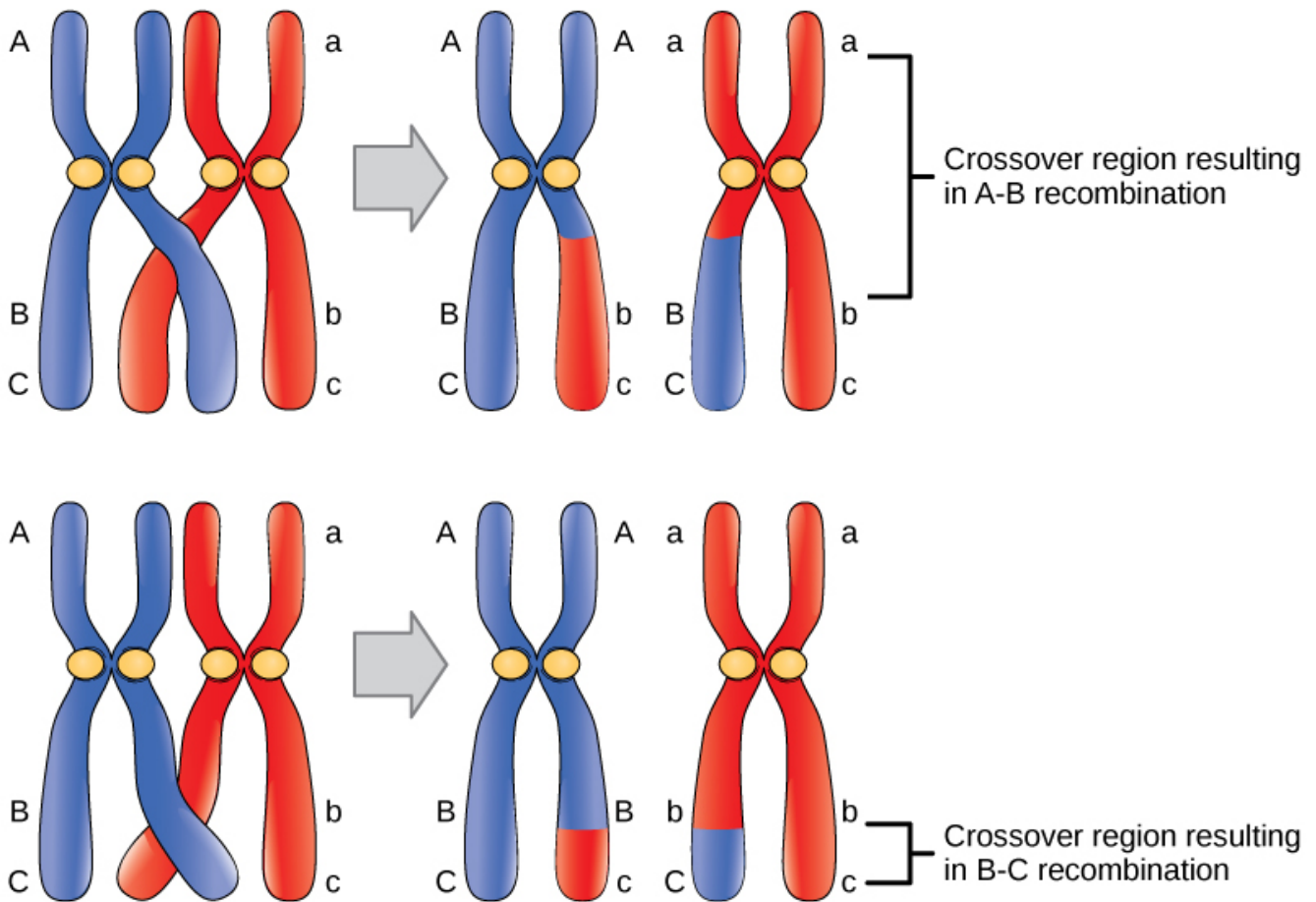

Figure 9.3.3 Two Different Instances of Crossing Over to Produce Different Recombinants [[Long description](#)]

Note: Watch the video, [Linked Genes, Crossing Over and Genetic Recombination](#), by AK Lectures (2015) on YouTube.

Recombination Frequency

Recombination frequency (RF) is a calculation to define the number of parental and recombinant gametes. The equation is as follows:

$$\text{Recombination frequency} = \left(\frac{\text{No. recombinant progeny}}{\text{Total no. of progeny}} \right) \times 100\%$$

Through identifying and defining parental and recombinant gametes, you can calculate the RF, and from there, decide the degree of linkage.

Based upon the equation and independent assortment, you can see that the recombination frequency cannot be higher than 0.50. If alleles are assorting independently, there will be a random distribution of alleles in the progeny – 50% will be recombinant gametes and 50% will be parental gametes, making the RF approximately 0.50. If a gene is linked, you will see a higher percentage of parental gametes, making the RF < 0.50. You will never see recombinant gametes

more than parental, and in no situation will recombination frequency be higher than 0.50, except slightly with regards to standard experimental error. If you calculate a recombination frequency higher than 0.50, you should ensure that you have accurately defined parental and recombinant gametes.

The video below, *Recombination Frequency and Linked Genes*, by John Chapman (2013) on YouTube, demonstrates the calculation of recombination frequency based on how often crossing over occurs.

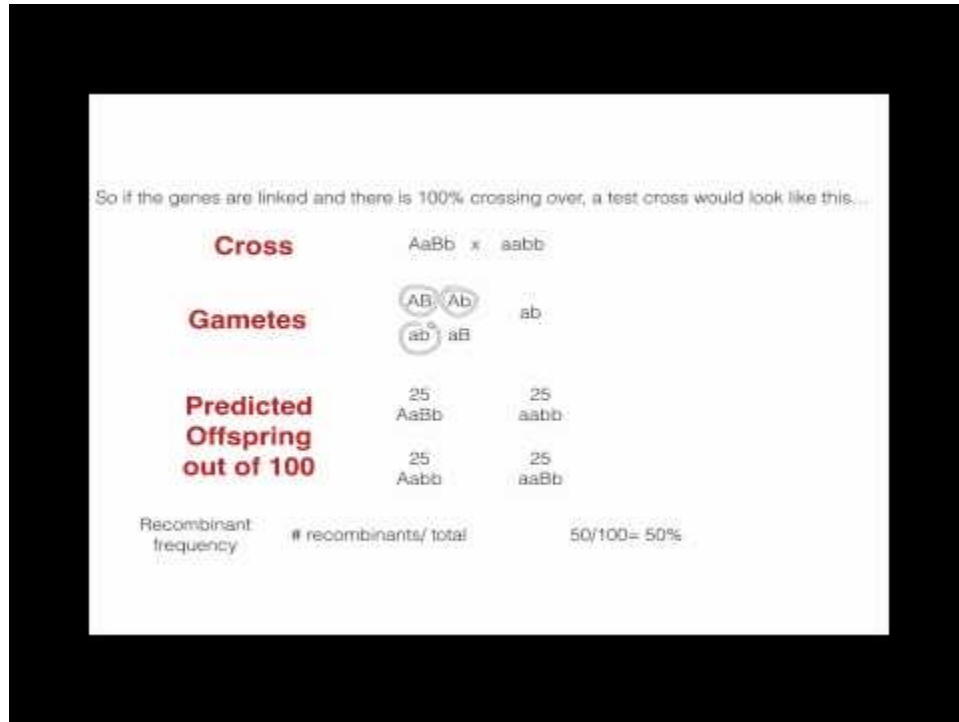

A YouTube element has been excluded from this version of the text. You can view it online here:

<https://opengenetics.pressbooks.tru.ca/?p=935>

Media Attributions

- **Figure 9.3.1 Original** by Deyholos (2017), [CC BY-NC 3.0](#), Open Genetics Lectures
- **Figure 9.3.2 Original** by Deyholos (2017), [CC BY-NC 3.0](#), Open Genetics Lectures
- **Figure 9.3.3 Figure 17 02 01** by Rye et al. (2016), [CNX OpenStax](#), [CC BY 4.0](#), via Wikimedia Commons

References

AK Lectures. (2015, January 15). Linked genes, crossing over and genetic recombination (video file). YouTube.
https://www.youtube.com/watch?v=99A6v-5_sFg

Bruck, E./khanacademymedicine. (2015, January 28). Genetic recombination 1 | Biomolecules | MCAT | Khan Academy (video file). YouTube. <https://youtu.be/BlnUNmfGn7I>

Chapman, J. (2013, December 18). Recombination frequency and linked genes (video file). YouTube. <https://www.youtube.com/watch?v=nJZCYd4fspY>

Deyholos, M. (2017). Figures: 3. When two loci are on non-homologous chromosomes, ...; and 4. The genotype of gametes ...[digital image]. In Locke, J., Harrington, M., Canham, L. and Min Ku Kang (Eds.), *Open Genetics Lectures, Fall 2017* (Chapter 18, p. 4). Dataverse/ BCcampus. http://solr.bccampus.ca:8001/bcc/file/7a7b00f9-fb56-4c49-81a9-cfa3ad80e6d8/1/OpenGeneticsLectures_Fall2017.pdf

Rye, C. et al. (2016, October 21). Figure 17.11 Crossover may occur at different locations on the chromosome [digital image]. In *Biology* (Chapter 17). OpenStax. <https://openstax.org/books/biology/pages/17-2-mapping-genomes>

Long Descriptions

- **Figure 9.3.1** Cell division (meiosis) shows non-linked genes and the outcome in gametes. When two loci are on non-homologous chromosomes, their alleles will segregate in combinations identical to those present in the parental gametes (Ab, aB), and in recombinant genotypes (AB, ab) that are different from the parental gametes. [Back to [Figure 9.3.1](#)]
- **Figure 9.3.2** The genotype of gametes can be inferred unambiguously if the gametes are produced by homozygotes. However, recombination frequencies can only be measured among the progeny of heterozygotes (i.e., dihybrids). The two sets of dihybrids shown here contain different configurations of alleles due to differences in the genotypes of their respective parents. Therefore, different gametes are defined as recombinant and parental among the progeny of the two dihybrids. In one cross, the recombinant gametes will be genotype AB and ab, and in the other cross, the recombinant gametes will be Ab and aB. [Back to [Figure 9.3.2](#)]
- **Figure 9.3.3** Two sets of homologous chromosomes are paired up during meiosis, showing crossing over of non-sister chromatids in both instances. Depending on the combination and order of alleles on the parental chromosomes, this will determine the nature and variety of recombinant genotypes after crossing over. [Back to [Figure 9.3.3](#)]

9.4 Coupling and Repulsion (cis and trans) Configuration

Just by looking at an organism that is heterozygous at two loci, you cannot tell how the mutant and wild type alleles are arranged. Both mutant alleles could be on one homologous chromosome, and both wild type alleles could be on the other (e.g., a^-b^- / A^+B^+). This is known as a **coupling** (or **cis**) **configuration**. When one wild type allele and one mutant allele are on one homologous chromosome, and the opposite is on the other, this is known as a **repulsion** (or **trans**) **configuration** (e.g., A^+b^- / a^-B^+). The way to determine the orientation is to look at the parents (or P generation) of that cross if you know the genotypes of them. If the parents are homozygous for both genes, and one shows both dominant phenotypes and the other shows both recessive phenotypes, then you know that the individual you are looking at is in coupling configuration. If one parent has one dominant and one recessive phenotype, and the other has the opposite, then you know the individual is in repulsion configuration.

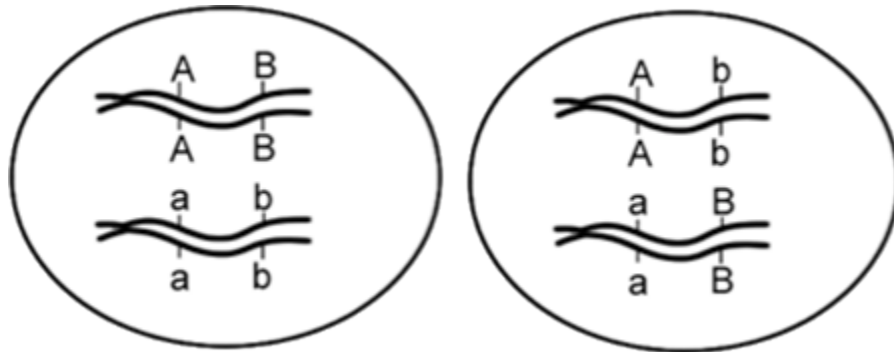
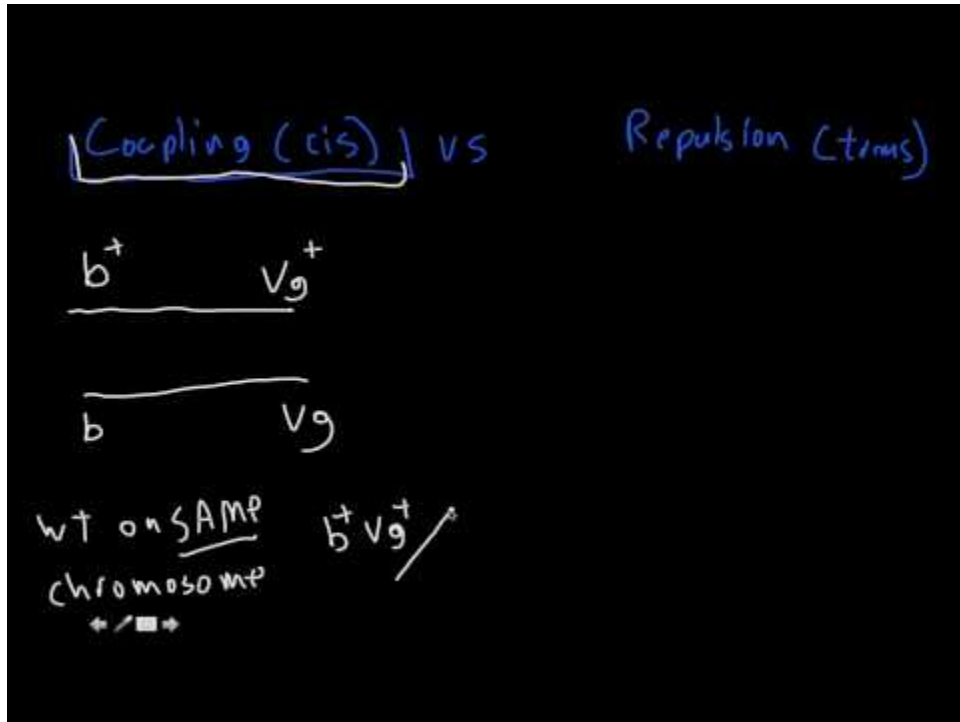

Figure 9.4.1 Alleles in Coupling Configuration (left) or Repulsion Configuration (right). [[Long description](#)]

The following video, *Genetics! coupling (cis) vs Repulsion (trans)*, by Medaphysics Repository (2015) on YouTube, discusses the difference between cis and trans genes.



A YouTube element has been excluded from this version of the text. You can view it online here:

<https://opengenetics.pressbooks.tru.ca/?p=1671>

The video, *Coupling vs Repulsion*, by Genetics Rocks (2019) on YouTube, looks at a worked example involving observed frequencies in a test cross and genes in coupling/repulsion.

Question 1

Perform a test cross:

$RrYy \times rryy$

Expected Frequencies:

25% of each genotype

	RY	Ry	rY	ry
rY	$RrYy$ 100%	$Rryy$ 100%	$rrYy$ 100%	$rryy$ 100%
rY	$RrYy$ 100%	$Rryy$ 100%	$rrYy$ 100%	$rryy$ 100%
rY	$RrYy$ 100%	$Rryy$ 100%	$rrYy$ 100%	$rryy$ 100%
rY	$RrYy$ 100%	$Rryy$ 100%	$rrYy$ 100%	$rryy$ 100%

Observed Frequencies:

$RrYy$: 0.07

$Rryy$: 0.48

$rrYy$: 0.39

$rryy$: 0.06

A YouTube element has been excluded from this version of the text. You can view it online here:

<https://opengenetics.pressbooks.tru.ca/?p=1671>

Media Attributions

- **Figure 9.4.1 Original** by Deyholos (2017), [CC BY-NC 3.0](https://creativecommons.org/licenses/by-nc/3.0/), Open Genetics Lectures

References

Deyholos, M. (2017). Figure 5. Alleles in coupling configuration...[digital image]. In Locke, J., Harrington, M., Canham, L. and Min Ku Kang (Eds.), *Open Genetics Lectures, Fall 2017* (Chapter 18, p. 4). Dataverse/ BCcampus.

http://solr.bccampus.ca:8001/bcc/file/7a7b00f9-fb56-4c49-81a9-cfa3ad80e6d8/1/OpenGeneticsLectures_Fall2017.pdf

Genetics Rocks. (2019, September 14). Coupling vs repulsion (video file). YouTube. <https://www.youtube.com/watch?v=ljNZPIWmgok>

Medaphysics Repository. (2015, February 24). Genetics! coupling (cis) vs Repulsion (trans) (video file). YouTube. <https://www.youtube.com/watch?v=4y5vjhMq6iY>

Long Description

- **Figure 9.4.1** Two cells showing alleles in either the coupling or cis configuration (whereby both mutant alleles are present on one homologous chromosome, and both wild type alleles are present on the other) or the repulsion or the trans configuration (whereby one wild type allele and one mutant allele are on one homologous chromosome, and the opposite is on the other). [Back to [Figure 9.4.1](#)]

9.5 Unlinked Genes vs. Partial Linkage vs. Complete Linkage

When comparing any two genes, they can be varying distances apart. Their RF allows us to categorize them into the degree of linkage. The amount of linkage can be placed on a sliding scale.

Table 9.5.1 shows, generally, how we categorize the degree linkage using recombination frequency. Because RF is based upon experimental results that will have some experimental error, these should be treated as guidelines and not hard rules in determining the distance between genes.

Table 9.5.1 The Linkage Description is Listed Corresponding to its Recombination Frequency.

Note: values between 0.30 and 0.50 may be partially linked, or may not be linked at all. It is often difficult to distinguish between these two possibilities because of experimental error.

Linkage Description	Recombination Frequency
Unlinked	Approximately 50% or more than 35%
Partial linkage	More than 0% to 30%
Complete linkage	0%

Unlinked Genes

Unlinked genes appear to segregate and show independent assortment. There will be a random and even distribution of gamete types, and an RF of 0.50 is the expectation. This situation occurs in two instances: either when the genes are on completely different chromosomes, or when they are far enough apart on a single chromosome that crossovers are so numerous that alleles are distributed randomly (**Figure 9.3.1**). Either way, because the alleles are assorting independently, you should observe an equal number of recombinant and parental gametes, with an RF near ~0.50. Note, because of real-life variability, this value can be anywhere from ~0.40 to ~0.60.

Complete Linkage

Having considered unlinked loci, let us turn to the opposite situation, in which two loci are so close together on a chromosome that the parental combinations of alleles always segregate together (**Figure 9.5.1**). This is because the physical distance between the two loci is so short that crossover events become extremely rare. Therefore, the alleles at the two loci are physically attached to the same chromatid and will nearly always segregate together into the same gamete. In this case, no recombinants will be present following meiosis, and the recombination frequency will be 0.00. This is **complete** (or **absolute**) **linkage** and is rare, as the loci must be so close together that crossovers are virtually impossible to detect.

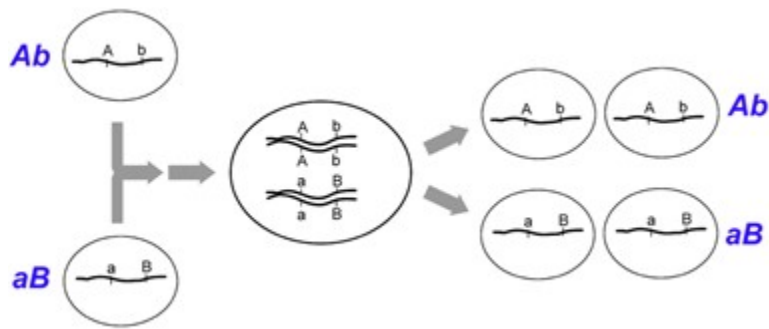

Figure 9.5.1 If Two Loci are Completely Linked, Their Alleles Will Segregate in Combinations Identical to Those Present in the Parental Gametes (Ab , aB). No recombinants will be observed. [[Long description](#)]

Partial Linkage

It is also possible to obtain recombination frequencies between 0% and 50%, which is a situation we call **incomplete** (or **partial**) **linkage**. Incomplete linkage occurs when two loci are located on the same chromosome, but the loci are far enough apart so that crossovers occur between them during some, but not all, meioses (**Figure 9.5.2**). Genes on the same chromosome are said to be **syntenic** regardless of whether they are completely or incompletely linked or unlinked. Thus, all linked genes are syntenic, but not all syntenic genes are linked.

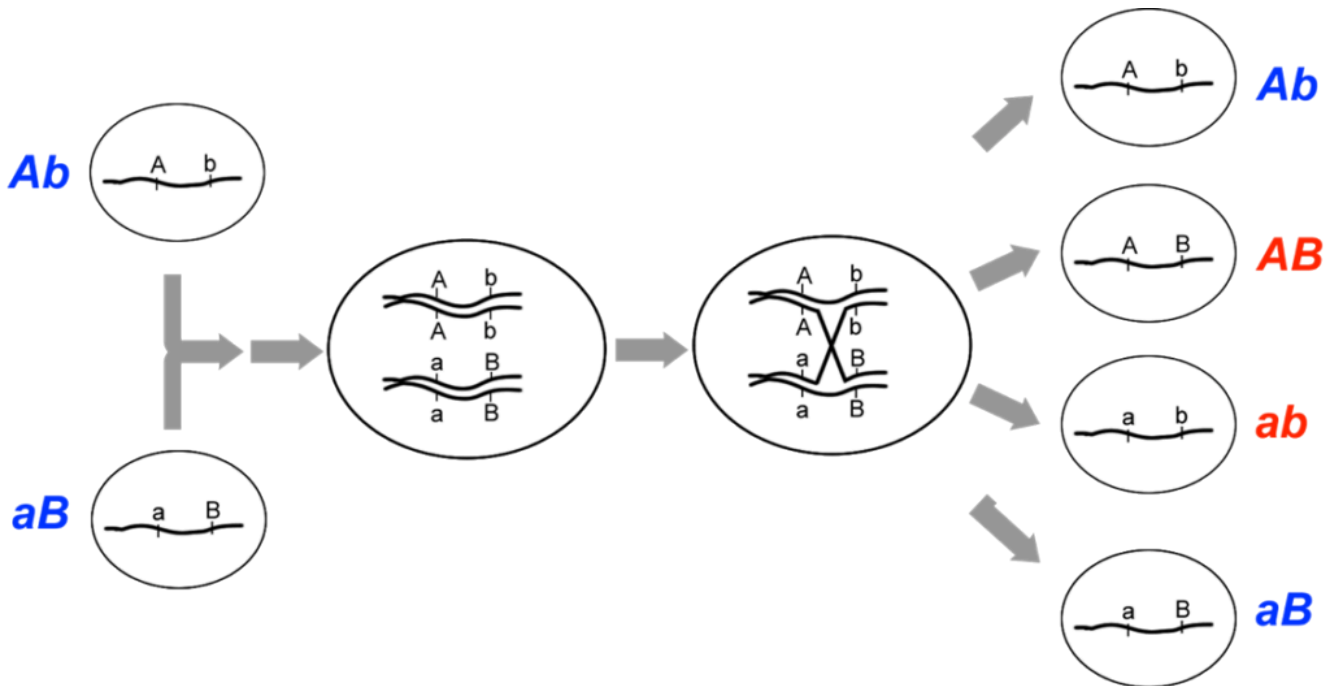
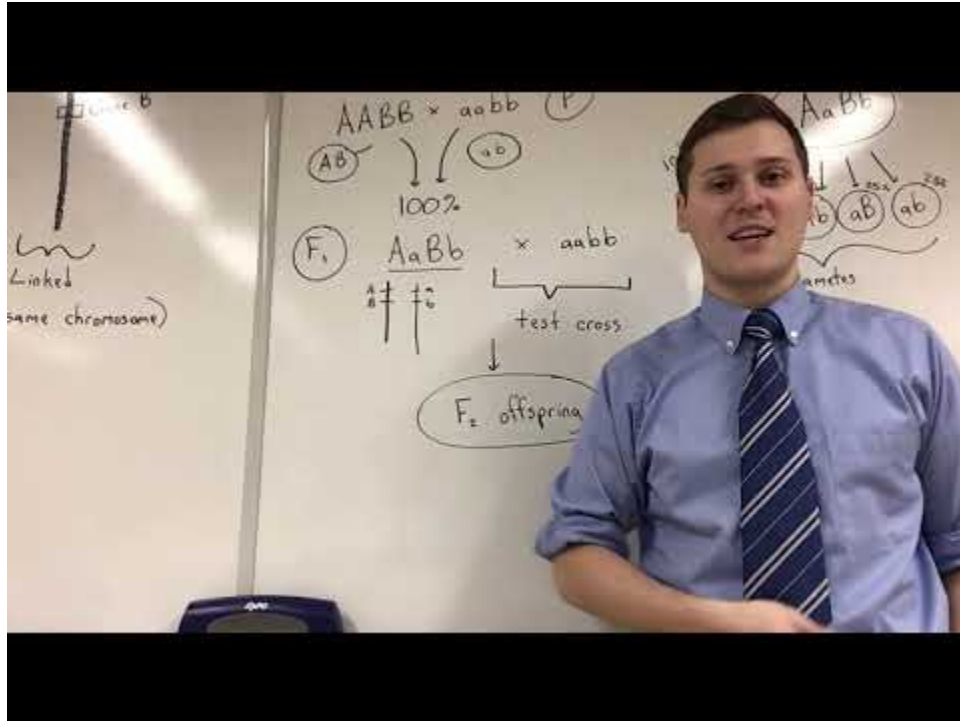

Figure 9.5.2 A Crossover Between Two Linked Loci Can Generate Recombinant Genotypes (AB , ab), From the Chromatids Involved in the Crossover. Remember that multiple, independent meioses occur in each organism, so this particular pattern of recombination will not be observed among all the meioses from this individual. [[Long description](#)]

Because the location of crossovers is essentially random for any given base pair of the chromosome, the greater the distance between two loci, the more likely a crossover will occur between them. Furthermore, loci on the same

chromosome, but sufficiently separated from one another, will on average have multiple crossovers between them, and they will behave indistinguishably from physically unlinked loci. A recombination frequency of 50% is therefore the maximum recombination frequency that can be observed, and indicative of loci that are either on separate chromosomes, or sufficiently separated on the same chromosome.

Watch the video, (AP Biology) *Linked Genes, Unlinked Genes, Incomplete Linkage, and Gene Mapping*, by Mr. Cronin's Videos (2019) on YouTube, which goes through a worked example involving linkage and gene mapping.



A YouTube element has been excluded from this version of the text. You can view it online here:

<https://opengenetics.pressbooks.tru.ca/?p=943>

Media Attributions

- **Figure 9.5.1** [Original](#) by Deyholos (2017), [CC BY-NC 3.0](#), Open Genetics Lectures
- **Figure 9.5.2** [Original](#) by Deyholos (2017), [CC BY-NC 3.0](#), Open Genetics Lectures

References

Deyholos, M. (2017). Figures: 6. If two loci...; and 7. A crossover between ...[digital image]. In Locke, J., Harrington, M., Canham, L. and Min Ku Kang (Eds.), *Open Genetics Lectures, Fall 2017* (Chapter 18, p. 6). Dataverse/ BCcampus. http://solr.bccampus.ca:8001/bcc/file/7a7b00f9-fb56-4c49-81a9-cfa3ad80e6d8/1/OpenGeneticsLectures_Fall2017.pdf

Mr. Cronin's Videos. (2019, December 18). (AP Biology) Linked genes, unlinked genes, incomplete linkage, and gene mapping (video file). YouTube. <https://www.youtube.com/watch?v=J3AskTp1dsk>

Long Descriptions

- **Figure 9.5.1** Complete linkage of two loci results in gametes, where alleles will segregate in combinations identical to those present in the parental gametes (Ab, aB) and therefore no recombinants will be observed. [Back to [Figure 9.5.1](#)]
- **Figure 9.5.2** The location of crossovers is essentially random for any given base pair of the chromosome; therefore, the greater the distance between two loci, the more likely a crossover will occur between them. A crossover between two linked loci can generate recombinant genotypes (AB ab), from the chromatids involved in the crossover. Multiple, independent meioses occur in each organism, so this particular pattern of recombination will not be observed among all the meioses from this individual. [Back to [Figure 9.5.2](#)]

9.6 Experimental Determination of Recombination Frequency

Let us now consider a complete experiment in which our objective is to measure recombination frequency (**Figure 9.6.1**). We need at least two alleles for each of two genes, and we must know which combinations of alleles were present in the parental gametes. The simplest way to do this is to start with pure-breeding lines with contrasting alleles at two loci. For example, we could cross short-tailed (aa), brown mice (BB) with long-tailed (AA), white mice (bb). Thus, ($aaBB$) are short-tailed and brown, while ($AAbb$) are long-tailed and white (**Figure 9.6.1** P cross). Based on the genotypes of the parents, we know that the parental gametes will be aB or Ab (but not ab or AB), and all the progeny will be dihybrids, $AaBb$. We do not know at this point whether the two loci are on different chromosomes, or whether they are on the same chromosome, and if so, how close they are to each other.

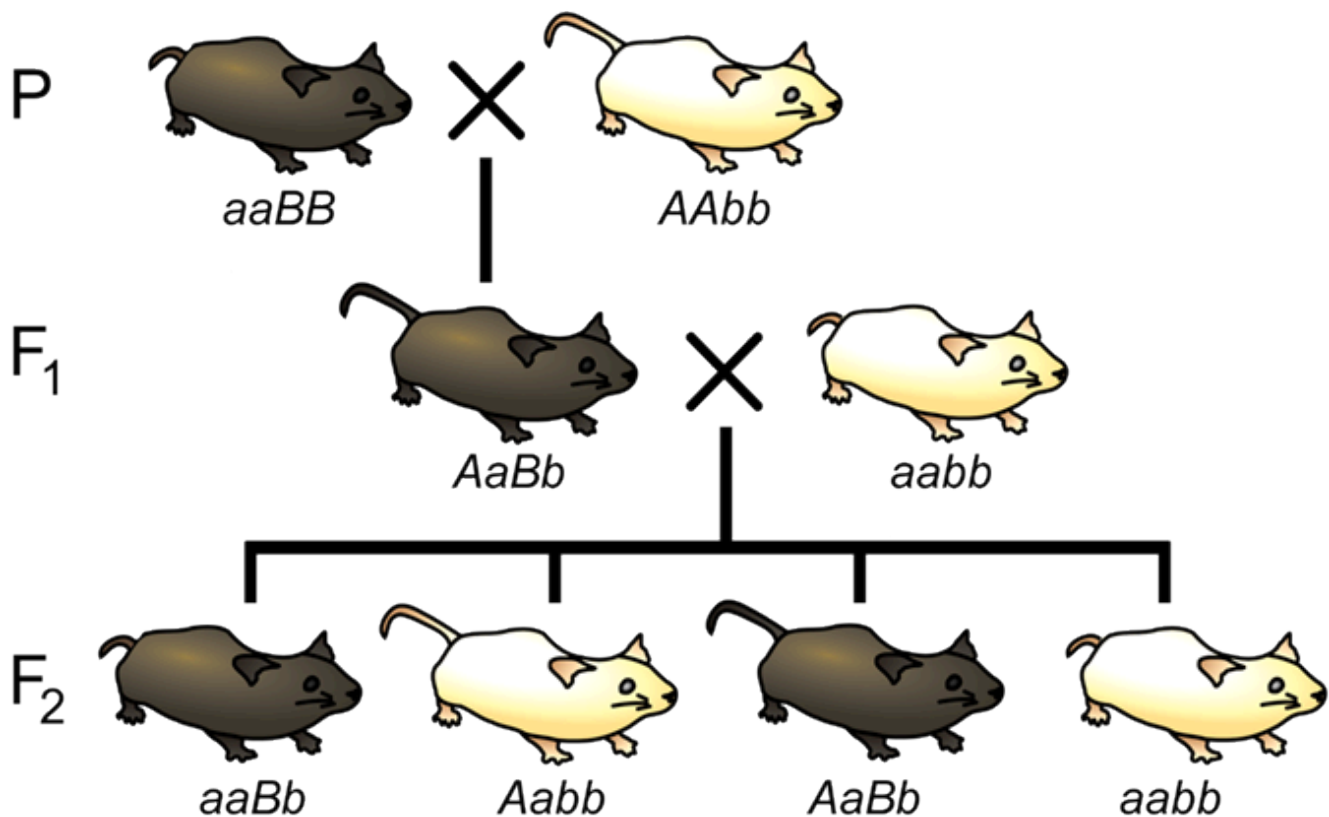

Figure 9.6.1 An Experiment to Measure Recombination Frequency Between Two Loci. The loci affect coat color (B/b) and tail length (A/a). [[Long description](#)]

The recombination events that may be detected will occur during meiosis in the dihybrid individual. If the loci are completely or partially linked, then prior to meiosis, alleles aB will be located on one chromosome, and alleles Ab will be on the other chromosome. These are the parental gametes based on our knowledge of the genotypes of the gametes that produced the dihybrid. Thus, recombinant gametes produced by the dihybrid will have the genotypes ab or AB .

Now that we have identified the parental and recombinant gametes, how do we determine the genotype of the gametes produced by the dihybrid individual? The most practical method is to use a test cross (**Figure 9.6.1** F₁ to tester), in other

words, to mate $AaBb$ to an individual with only recessive alleles at both loci ($aabb$). This will give a different phenotype in the second generation for each of the four possible combinations of alleles in the gametes of the dihybrid (**Figure 9.6.2**).

♂ ♀	AB	Ab	aB	ab
ab	Aa Bb	Aa bb	aa Bb	aa bb
phenotype	Long Brown	Long White	Short Brown	Short White
recombinant or parental	R	P	P	R

Figure 9.6.2 Punnett Square of Example Test Cross. Homozygous recessive tester can only produce one gamete type, so only one is listed. Phenotypes are listed below. Using the phenotypes and what we know of the parents, we can identify which phenotypes came from recombinant or parental gametes. [[Long description](#)]

We can then infer unambiguously the genotype of the gametes produced by the dihybrid individual, and therefore calculate the recombination frequency between these two loci. For example, if only two phenotypic classes were observed in the F₂ (i.e., short tails and brown fur ($aaBb$), and white fur with long tails ($Aabb$), we would know that the only gametes produced following meiosis of the dihybrid individual were of the parental type: aB and Ab , and the recombination frequency would therefore be 0%. Alternatively, we may observe multiple classes of phenotypes in the F₂ in ratios, as shown in **Table 9.6.1**.

Table 9.6.1 Example of quantitative data observed in a genetic mapping experiment involving two loci – data correspond to the F₂ generation in the cross shown in **Figure 9.5.2**.

Tail Phenotype	Fur Phenotype	Number of Progeny	Gamete from Dihybrid	Genotype of F ₂ from Test Cross	(P)arental or (R)ecombinant
Short	Brown	48	aB	$aaBb$	P
Long	White	42	Ab	$Aabb$	P
Short	White	13	ab	$aabb$	R
Long	Brown	17	AB	$AaBb$	R

Given the data in **Table 9.6.1**, the calculation of recombination frequency is straightforward:

$$\text{RF} = \frac{\text{\# recombinant offspring}}{\text{Total offspring}} = \frac{13+17}{48+42+13+17} = 0.25$$

Because the recombination frequency is below 0.30, we can say that the tail length gene and the fur colour gene are partially linked.

Note: The use of linkage and recombination frequency will be extended to Genetic Mapping in [Chapter 11](#).

Media Attributions

- **Figure 9.6.1** [Original](#) modified by Deyholos (2017), [CC BY-NC 3.0](#), Open Genetics Lectures
- **Figure 9.6.2** [Original](#) by Canham (2017), [CC BY-NC 3.0](#), Open Genetics Lectures

References

Canham, L. (2017). Figure 9. Punnett Square of example test cross...[digital image]. In Locke, J., Harrington, M., Canham, L. and Min Ku Kang (Eds.), *Open Genetics Lectures, Fall 2017* (Chapter 18, p. 7). Dataverse/ BCcampus.

http://solr.bccampus.ca:8001/bcc/file/7a7b00f9-fb56-4c49-81a9-cfa3ad80e6d8/1/OpenGeneticsLectures_Fall2017.pdf

Deyholos, M. (2017). Figure 8. An experiment to measure recombination frequency...[digital image]. In Locke, J., Harrington, M., Canham, L. and Min Ku Kang (Eds.), *Open Genetics Lectures, Fall 2017* (Chapter 18, p. 7). Dataverse/ BCcampus.

http://solr.bccampus.ca:8001/bcc/file/7a7b00f9-fb56-4c49-81a9-cfa3ad80e6d8/1/OpenGeneticsLectures_Fall2017.pdf

Media Attributions

- **Figure 9.6.1** Punnett square showing Parental, F1 and F2 generations, to show the production of recombinant progeny, which allows the researcher to measure recombination frequency between two partially-linked loci. The traits being investigated here are coat colour and tail length. [Back to [Figure 9.6.1](#)]
- **Figure 9.6.2** A Punnett square shows an example of a test cross. The homozygous recessive tester organism can only produce one gamete type, so only one is listed. Phenotypes are listed below each genotype. Using the phenotypes and what we know of the parents, we can identify which phenotypes came from recombinant or parental gametes. [Back to [Figure 9.6.2](#)]

Chapter 9 Summary

The topics covered in this chapter can be summarized as follows:

- Recombination is defined as any process that results in gametes with combinations of alleles that were not present in the gametes of a previous generation.
- The recombination frequency between any two loci depends on their relative chromosomal locations.
- Unlinked loci show a maximum 50% recombination frequency.
- Loci that are close together on a chromosome are linked and tend to segregate with the same combinations of alleles that were present in their parents.
- Crossovers are a normal part of most meioses, and allow for recombination between linked loci.
- Measuring recombination frequency is easiest when starting with pure-breeding lines with two alleles for each locus, and with suitable lines for test crossing.

Key Terms in Chapter 9

Key Terms – Linkage and Recombination Frequency

- allele
- complete (absolute) linkage
- coupling (cis) configuration
- crossover
- gene
- genotype
- incomplete (partial) linkage
- independent assortment
- interchromosomal recombination
- intrachromosomal recombination
- linkage
- locus
- parental genotype (and gametes)
- phenotype
- recombinant genotype (and gametes)
- recombination frequency (RF)
- recombination
- repulsion (trans) configuration
- Second Law of Independent Assortment
- synapsis
- syntenic
- unlinked

Chapter 9 Study Questions

1. Compare the terms “recombination” and “crossover”. How are they similar? How are they different?
2. Explain why it is usually necessary to start with pure-breeding lines when measuring genetic linkage by the methods presented in this chapter.
3. Suppose you knew that in a population, a trait (allele at a locus) that dominantly affected earlobe shape was tightly linked to a trait that dominantly affected susceptibility to cardiovascular disease in humans. Under what circumstances would this information be clinically useful?
4. In a previous chapter, we said a 9:3:3:1 phenotypic ratio was expected among the progeny of a dihybrid cross, in absence of gene interaction.
 - a. What does this ratio assume about the linkage between the two loci in the dihybrid cross?
 - b. What ratio would be expected if the loci were completely linked? Be sure to consider every possible configuration of alleles in the dihybrids.
5. Given a dihybrid with the genotype $CcEe$:
 - a. If the alleles are in coupling (cis) configuration, what will be the genotypes of the parental and recombinant progeny from a test cross?
 - b. If the alleles are in repulsion (trans) configuration, what will be the genotypes of the parental and recombinant progeny from a test cross?
6. In this question, the white flowers (w) are recessive to purple flowers (W), and yellow seeds (y) are recessive to green seeds (Y). If a green-seeded, purple-flowered dihybrid is test crossed, and half of the progeny have yellow seeds.
 - a. What can you conclude about linkage between these loci?
 - b. What do you need to know about the progeny in this case?
7. If the progeny of the cross $aaBB \times AAbb$ is test crossed, and the following genotypes are observed among the progeny of the test cross, what is the frequency of recombination between these loci?

$AaBb$	135
$Aabb$	430
$aaBb$	390
$aabb$	120
8. What is meant by the sentence “All linked genes are syntenic, but not all syntenic genes are linked.”?

Chapter 9 Answers

- Crossovers can be observed cytologically directly under the microscope as chiasmata.
 - Recombination is defined genetically as the frequency calculated from the observed phenotypic proportions in the progeny.
 - Crossovers lead to recombination when they are detected using genetic marker loci.
 - Not all crossovers result in recombination – some can't be detected because no visible markers are recombined.
 - Some recombinants involve crossovers, but not all recombinants result from crossovers.
 - Crossovers between non-sister chromatids can result in recombination, while crossovers between sister chromatids, which have identical alleles, will not show any recombination.
 - When there are two crossovers between the loci being scored for recombination, the result will appear to be parental, not recombinant.
 - Recombination can occur without crossovers when marker loci are on different chromosomes, which then assort independently.
2. The use of pure breeding lines allows the researcher to be sure that he/she is working with homozygous (known) genotypes. If a parent is known to be homozygous, then all its gametes will have the same genotype. This simplifies the definition of parental genotypes and therefore the calculation of recombination frequencies.
3. This tight linkage would suggest that individuals with the earlobe phenotype would likely carry alleles that increased their risk of cardiovascular disease. These individuals could, therefore, be informed of their increased risk and have an opportunity to seek increased monitoring and reduce other risk factors.
- a. It assumes that the loci are completely unlinked.
 - b. The expected ratio would be all parentals and no recombinants. For example, if the parental gametes were *AB* and *ab*, then the gametes produced by the dihybrids would also be *AB* and *ab*, and the offspring of a cross between the two dihybrids would all be genotype *AABB*: *AaBb*: *aabb*, in a 1:2:1 ratio. If the parental gametes were *Ab* and *aB*, then the gametes produced by the dihybrids would also be *Ab* and *aB*, and the offspring of a cross between the two dihybrids would all be genotype *AAbb*: *AaBb*: *aaBB*, in a 1:2:1 ratio.
- a. Parental: *CcEe* and *ccee*; Recombinant: *Ccee* and *ccEe*
 - b. Parental: *Ccee* and *ccEe*; Recombinant: *CcEe* and *ccee*
- a. Let *WwYy* be the genotype of a purple-flowered (*W*), green seeded (*Y*) dihybrid. The cross is *WwYy* × Half of the progeny will have yellow seeds whether the loci are linked or not. You cannot tell if they are linked or not given only this information.
 - b. You need to know the proportion of the seeds that are white or purple flowered, and in what frequencies they appear with the white and purple flowers, e.g., what the frequencies of the four classes are. This would help you to know about the linkage between the two loci – unlinked, or what degree of linkage.
4. If the progeny of the cross *aaBB* × *AAbb* is test crossed, and the following genotypes are observed among the progeny of the test cross, what is the frequency of recombination between these loci?
- | | | | |
|-----------------|-----------------|-----------------|-----------------|
| <i>AaBb</i> 135 | <i>Aabb</i> 430 | <i>aaBb</i> 390 | <i>aabb</i> 120 |
|-----------------|-----------------|-----------------|-----------------|
- $$\frac{(135+120)}{(135+120+390+430)}=24\%$$
5. Syntenic is the term for genes found on the same chromosome. Linked genes are always found on the same chromosome, and so are always syntenic. If the genes are sufficiently far enough away on the same chromosome, crossover events will make the two genes assort independently, so they won't appear linked. Therefore, in this latter situation, these genes are syntenic, but not linked.

CHAPTER 10 - SEX CHROMOSOMES & SEX LINKAGE

10.1 Introduction

Learning Objectives

- Distinguish between autosomes and sex chromosomes.
- Discuss sex-linkage as an exception to Mendel's First Law.
- Describe sex-linked pattern of inheritance, with specific reference to *Drosophila melanogaster* as a model genetic organism.
- Discuss the role of the Y-chromosome in sex-determination.
- Recall and describe selected Y-linked characteristics.

Previously, Mendel, working with plants, showed patterns of inheritance derived from gene loci on **autosomal** chromosomes. One complication to this model of inheritance in animals is that loci present on sex chromosomes (see **Figure 10.1.1** for example), called **sex-linked** loci, don't follow this pattern. This chapter covers the various patterns of inheritance for various sex-linked loci.



Figure 10.1.1 The E/e Gene in Turkeys is Responsible for Bronze or Brown Feather Colour, and is Located on the Z-Chromosome. [[Long description](#)]

Figure 10.1.2 shows that most of the chromosomes in humans are present in two copies. Each copy has the same length, centromere location, and banding pattern. As mentioned before, these are called autosomes. However, note that two of the chromosomes, the X and the Y, do not look alike. These are **sex chromosomes**. In mammals, males have one of each while females have two X chromosomes.

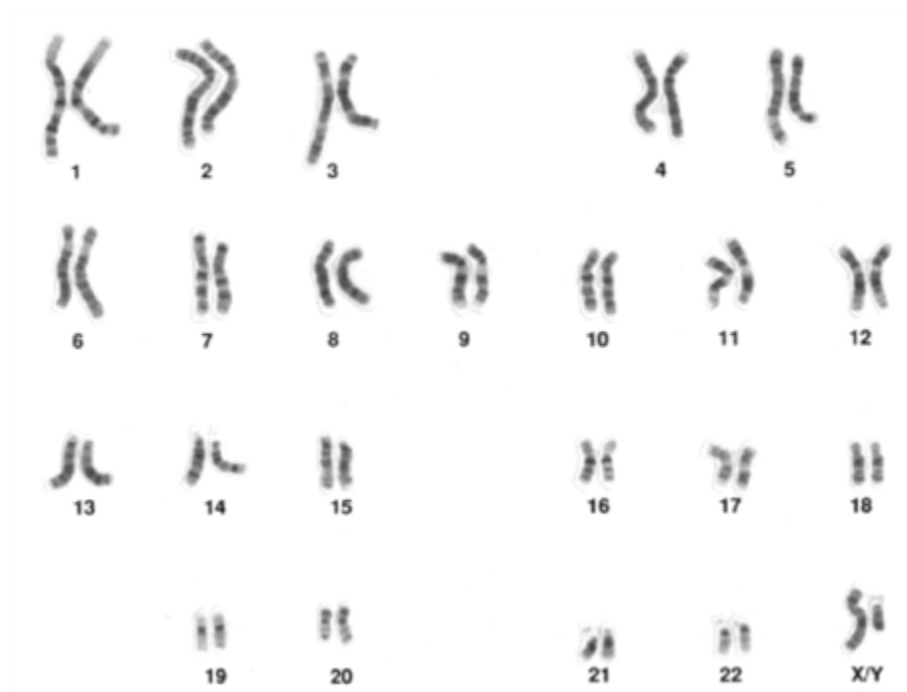

Figure 10.1.2 Karyogram of a Normal Human Male [[Long description](#)]

Watch the video below, *Sex Determination | Genetics | Biology | FuseSchool*, presented by FuseSchool – Global Education (2017) on YouTube, which describes how the sex-chromosomes play a role in sex-determination in humans.



A YouTube element has been excluded from this version of the text. You can view it online here:

<https://open.genetics.pressbooks.tru.ca/?p=980>

Media Attribution

- **Figure 10.1.1** [Wild Turkey strut](#) by [Steve Voght](#), [CC BY-SA 2.0](#), via Flickr
- **Figure 10.1.2** [Human male karyotype high resolution](#) by National Human Genome Research Institute/ [Talking Glossary of Genetics](#), [public domain](#), via Wikipedia

Reference

FuseSchool – Global Education. (2017, November 27). Sex determination | genetics | biology | FuseSchool (video file). YouTube. <https://youtu.be/D2hVgujy2E8>

Long Descriptions

- **Figure 10.1.1** A turkey demonstrates the phenotype of a bronze feather color, which is a gene located on the Z-chromosome or a sex chromosome of this animal. Sex-linked characteristics (e.g., bronze or brown feather color in turkeys) show different inheritance patterns than autosomal linked traits. [Back to [Figure 10.1.1](#)]
- **Figure 10.1.2** A karyogram, which is a visualization of all the chromosomes in their condensed state of a cell in a

particular organism. Here, 23 pairs of chromosomes are observed in a somatic cell of a human male: we see 22 pairs of autosomes and one pair of sex-chromosomes which are labelled XY. The Y chromosome is significantly smaller than the X chromosome. [Back to [Figure 10.1.2](#)]

10.2 Autosomes and Sex Chromosomes

In diploids, most chromosomes exist in pairs (same length, centromere location, and banding pattern), with one set coming from each parent. These chromosomes are called **autosomes**. However, many species have an additional pair of chromosomes that do not look alike. These are **sex chromosomes** because they differ between the sexes. In humans, males have one of each while females have two X chromosomes. Autosomes are those chromosomes present in the same number in males and females, while sex chromosomes are those that are not. When sex chromosomes were first discovered, their function was unknown, and the name X was used to indicate this mystery. The next ones were named Y, then Z, and then W (depending on the species).

The combination of sex chromosomes within a species is associated with either male or female individuals. In mammals, fruit flies, and some dioecious plants, those with two X chromosomes are females, while those with an X and a Y are males. In birds, moths, and butterflies, males are ZZ and females are ZW. Because sex chromosomes have arisen multiple times during evolution the molecular mechanism(s) through which they determine sex differs among those organisms. For example, although humans and *Drosophila* both have X and Y sex chromosomes, they have different mechanisms for determining sex (see [Chapter 11](#)).

How do the sex chromosomes behave during meiosis? Well, in those individuals with two of the same chromosomes (i.e., **homogametic** sexes: XX females and ZZ males), the chromosomes pair and segregate during meiosis I, the same as autosomes. During meiosis in XY males or ZW females (**heterogametic** sexes), the sex chromosomes pair with each other.

Take a look at this video, *7R – Sex chromosomes in Meiosis*, produced by Professor Redfield of UBC (Useful Genetics, 2015), which discusses what occurs with sex chromosomes during meiosis.

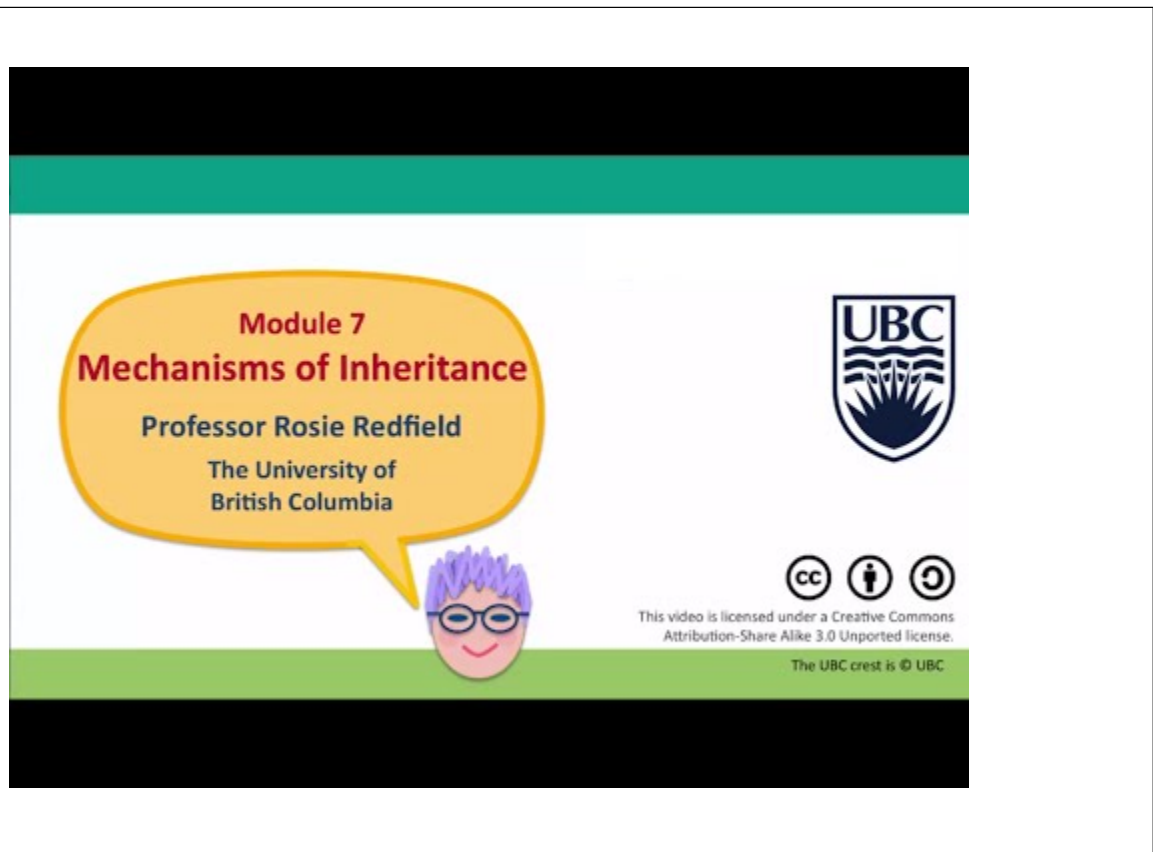

A YouTube element has been excluded from this version of the text. You can view it online here:
<https://opengenetics.pressbooks.tru.ca/?p=987>

In mammals (XX, XY), the consequence is all egg cells will carry an X chromosome, while the sperm cells will carry either an X or a Y chromosome. Half of the offspring will receive two X chromosomes and become female, while half will receive an X and a Y and become male (**Figure 10.3**). In species with ZZ males, all sperm carry a Z chromosome, while in females, ZW, half will have a Z and half a W.

It is a popular misconception that the X and Y chromosomes were named based upon their shapes; physically each looks like any other chromosome. A Y-chromosome doesn't look like a Y any more than a chromosome 4 looks like a 4. The combination of sex chromosomes within a species is associated with either male or female individuals. In mammals, fruit flies, and some flowering plants, XX individuals are females, while XY individuals are males.

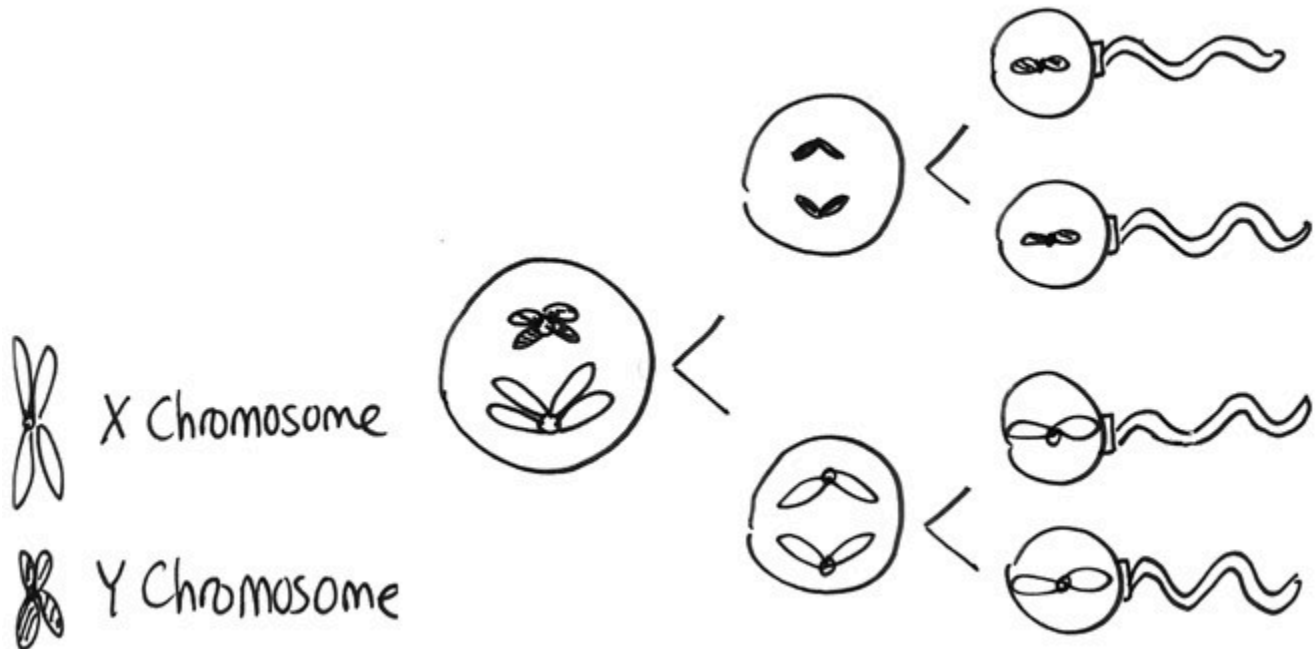

Figure 10.2.1 Meiosis in an XY Mammal. The stages shown are anaphase I, anaphase II, and mature sperm. Note how half of the sperm contain Y chromosomes and half contain X chromosomes. [[Long description](#)]

Media Attributions

- **Figure 10.2.1** [Original](#) by M. Harrington (2017), [CC BY-NC 3.0](#), Open Genetics Lectures

References

Harrington, M. (2017). Figure 2. Meiosis in an XY mammal [digital image]. In Locke, J., Harrington, M., Canham, L. and

Min Ku Kang (Eds.), *Open Genetics Lectures, Fall 2017* (Chapter 20, p. 2). Dataverse/ BCcampus.
[http://solr.bccampus.ca:8001/bcc/file/7a7b00f9-fb56-4c49-81a9-cfa3ad80e6d8/1/
OpenGeneticsLectures_Fall2017.pdf](http://solr.bccampus.ca:8001/bcc/file/7a7b00f9-fb56-4c49-81a9-cfa3ad80e6d8/1/OpenGeneticsLectures_Fall2017.pdf)

Redfield, R./ UBC [Useful Genetics]. (2015, August 23). 7R – Sex chromosomes in meiosis (video file). YouTube.
https://www.youtube.com/watch?v=kiZWI_yuGDM

Long Description

- **Figure 10.2.1** The process of meiosis in a human male demonstrates the stages of anaphase I, anaphase II, and mature sperm cells. Half of the sperm cells produced contain an X chromosome, and half of the sperm cells contain a Y chromosome. This indicates males can only pass on their Y linked traits to their sons, not their daughters. [Back to [Figure 10.2.1](#)]

10.3 Pseudo-Autosomal Regions on the X and Y Chromosomes

In evolution, before the X and Y chromosomes differentiated, they used to be equivalent homologs, like an autosome. Over time, the Y chromosome lost most of its genes (hence the reduced size), but the X chromosome retained all its genes. Thus, even though the Y chromosome has lost most of its genes, it still shares some regions with the X chromosome. This is the reason why although X and Y chromosomes are **heteromorphic** (morphologically dissimilar), they are able to act as a homologous pair in meiosis and undergo crossover. These common regions, which contain similar genes, permit the X and Y to pair up, and are called the “**pseudo-autosomal regions**”. The name comes from the observation that genes in these regions behave like autosomes in their inheritance. Alleles of the genes in this region crossover just like those on the autosomes. Thus, genes in this region are not inherited in a sex-linked pattern, even though they are located on the X chromosome.

The genes found in pseudo-autosomal region are present in two copies in both XY males and XX females, and, thus, expressed from both active and inactive X chromosomes. These genes may explain clinical features in sex chromosome aneuploidy (addition or subtraction of a sex chromosome; e.g., XXY) as gene products may be either under- or over-expressed in relation to normal females and males.

One of the genes in this region is called SHOX. It makes a protein that promotes bone growth. 46,XX and 46,XY people have two functioning copies and have average height. People with 47,XYY and 47,XXX genomes have three copies and are taller than average. And people with 45,X have one copy and are short. It is the single copy of SHOX and a few other genes in the pseudo-autosomal region that causes health problems for women with Turner syndrome.

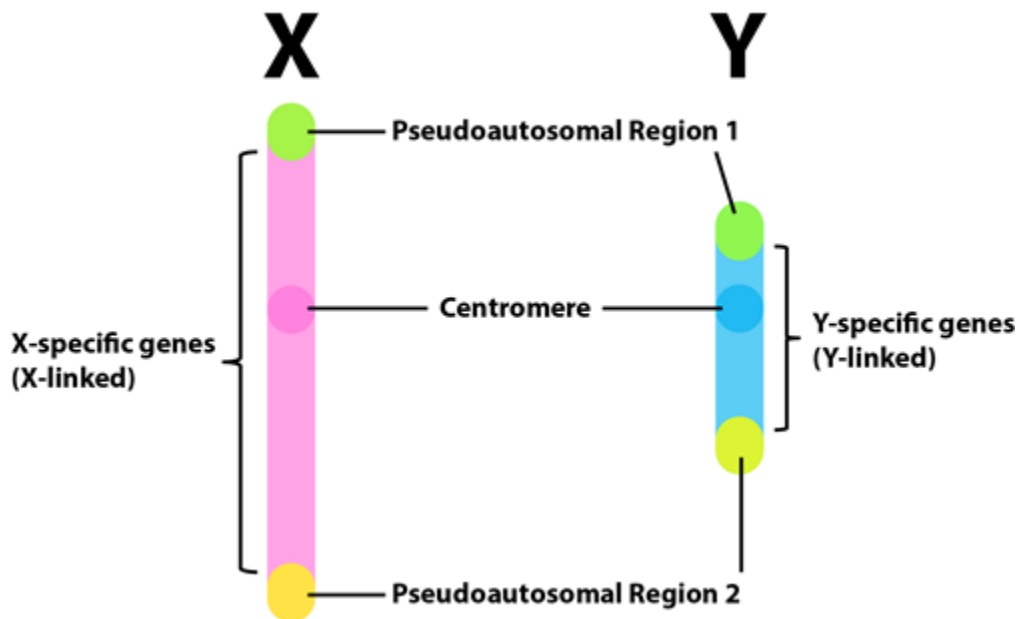
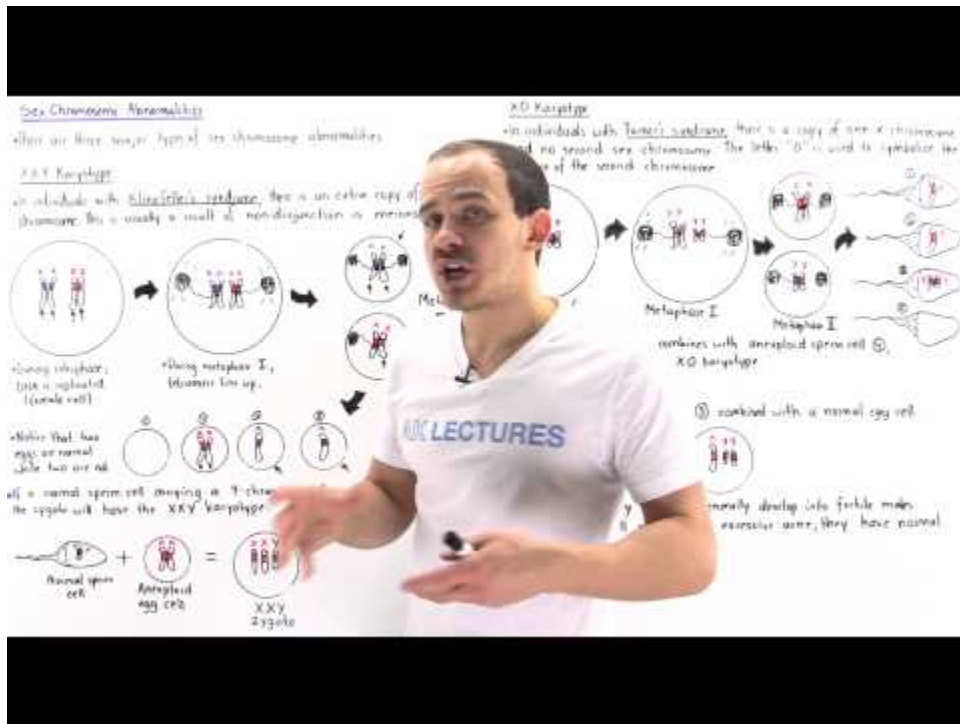

Figure 10.3.1 X and Y Chromosome have Pseudoautosomal Regions, Which are Capable of Pairing During Meiosis and Recombination. [[Long description](#)]

Take a look at this video, *Sex Chromosome Abnormalities*, part of the AK Lectures (2015) series which discusses abnormalities which can occur with the sex chromosomes.



A YouTube element has been excluded from this version of the text. You can view it online here:

<https://opengenetics.pressbooks.tru.ca/?p=993>

Media Attribution

- **Figure 10.3.1** [Original](#) by Locke/Kang (2017), [CC BY-NC 3.0](#), Open Genetics Lectures

References

AK Lectures. (2015, January 15). Sex chromosome abnormalities (video file). <https://www.youtube.com/watch?v=gdXHq8FrFHI>

Locke, J., Kang, M.K. (2017). Figure 3. X and Y chromosome have pseudoautosomal regions [digital image]. In Locke, J., Harrington, M., Canham, L. and Min Ku Kang (Eds.), *Open Genetics Lectures, Fall 2017* (Chapter 20, p. 2). Dataverse/BCcampus. http://solr.bccampus.ca:8001/bcc/file/7a7b00f9-fb56-4c49-81a9-cfa3ad80e6d8/1/OpenGeneticsLectures_Fall2017.pdf

Long Description

- **Figure 10.3.1** An X chromosome and a Y chromosome, showing centromeres, and Pseudoautosomal regions, are

able to pair up during meiosis. Crossing over does not occur, since the X and Y chromosomes are heteromorphic. However, pairing up homologous chromosomes is necessary for proper division of nuclei during meiosis. [[Back to Figure 10.3.1](#)]

10.4 Sex Linkage: An Exception to Mendel's First Law

We have introduced sex chromosomes and autosomes (non-sex-linked chromosomes). For loci on autosomes, the alleles follow the classic Mendelian pattern of inheritance. However, for loci on the sex chromosomes this doesn't follow because most (not all) of the loci on the typical X-chromosome are absent from the Y-chromosome, even though they act as a homologous pair during meiosis. Instead, they will follow a **sex-linked** pattern of inheritance. An X-linked allele in the father will always be passed on to his daughters only, but an X-linked allele in the mother will be passed on to both daughters and sons equally.

X-Linked Genes: The White Gene in *Drosophila Melanogaster*

A well-studied, sex-linked gene is the *white* gene on the X chromosome of *Drosophila melanogaster*. Normally flies have red eyes, but flies with a mutant allele of this gene called *white*⁻ (*w*⁻) have white eyes because the red pigments are absent. Because this mutation is recessive to the wild type *w*⁺ allele, females that are heterozygous have normal red eyes. Female flies that are homozygous for the mutant allele have white eyes. Because there is no *white* gene on the Y chromosome, male flies can only be hemizygous for the wild type allele or the mutant allele.

A researcher may not know beforehand whether a novel mutation is sex-linked. The definitive method to test for sex-linkage is **reciprocal crosses** (Figure 10.4.2). This means to cross a male and a female that have different phenotypes, and then conduct a second set of crosses, in which the phenotypes are reversed relative to the sex of the parents in the first cross. For example, if you were to set up reciprocal crosses with flies from pure-breeding *w*⁺ and *w*⁻ strains the results would be as shown in Figure 10.4.2. Whenever reciprocal crosses give different results in the F₁ and F₂ and whenever the male and female offspring have different phenotypes the usual explanation is sex-linkage. Remember, if the locus were autosomal, the F₁ and F₂ progeny would be different from either of these crosses.

A similar pattern of sex-linked inheritance is seen for X-chromosome loci in other species with an XX-XY sex chromosome system, including mammals and humans.

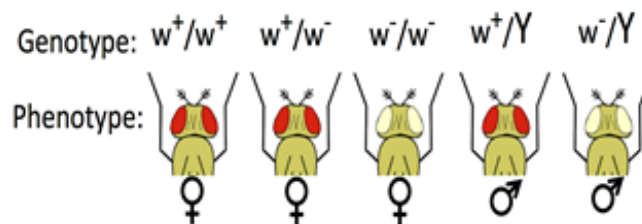

Figure 10.4.1 – Relationship between genotype and phenotype for the *white* gene on the X-linked gene in *Drosophila melanogaster*. The Y chromosome is indicated with a capital Y because it does not have a copy of the *white* gene. [[Long description](#)]

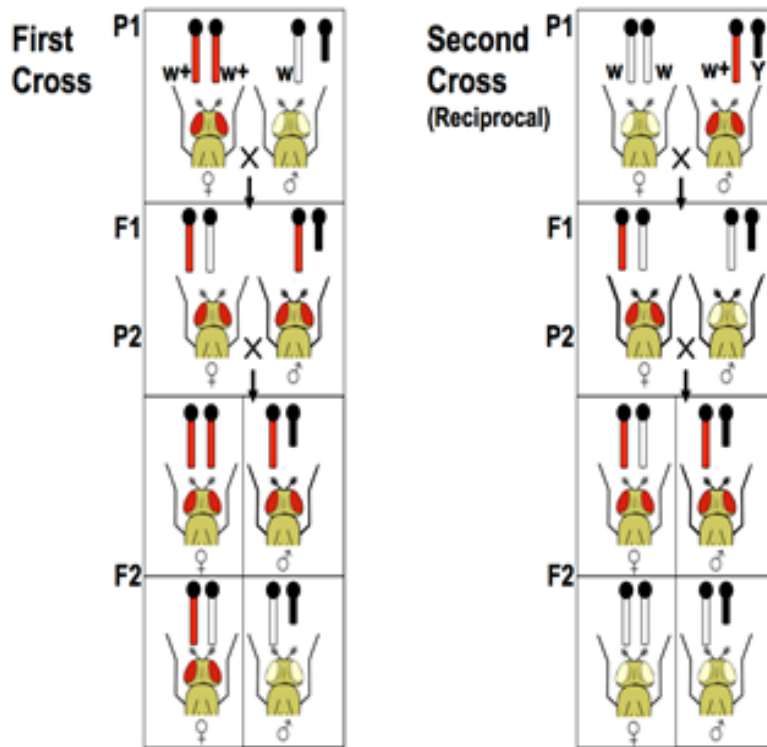
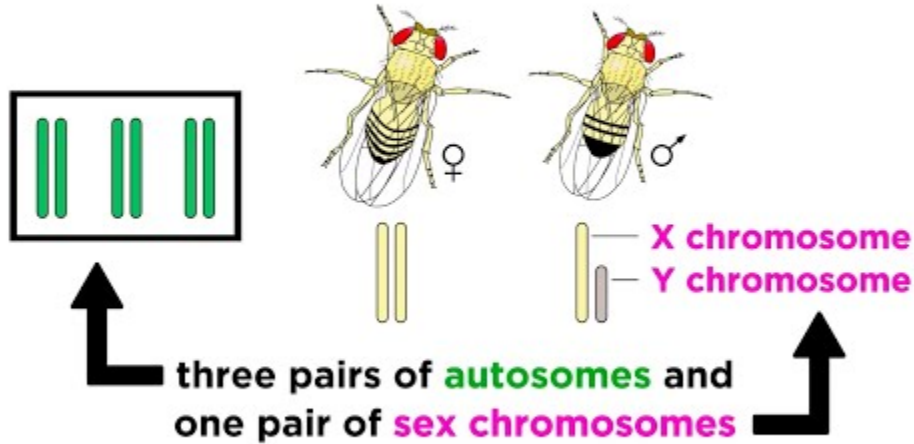

Figure 10.4.2 Reciprocal crosses involving an X-linked gene in *Drosophila melanogaster*. In the first cross (left), all offspring have red eyes. In second (reciprocal) cross (right), all female offspring have red eyes and male offspring all have white eyes. If the F1 progeny are crossed (to make the P2), the F2 progeny will be different in each cross. The first cross has all red-eyed females and half red-eyed males. The reciprocal cross has half red-eyed males and females. [[Long description](#)]

Thomas Morgan was awarded the Nobel Prize, in part, for using crosses like the ones represented in **Figure 10.4.2**, to demonstrate that genes (such as white) were on chromosomes – in this case the X-chromosome.

Take a look at the video below, *Inheritance of X-Linked Genes*, presented by Professor Dave Explains (2020), which discusses the inheritance of sex-linked traits.

fruit flies have **four pairs of chromosomes**



A YouTube element has been excluded from this version of the text. You can view it online here:

<https://opengenetics.pressbooks.tru.ca/?p=999>

Media Attributions

- **Figure 10.4.1 Original** by Deyholos/Harrington/Locke (2017), [CC BY-NC 3.0](#), Open Genetics Lectures
- **Figure 10.4.2 Original** by Deyholos/Harrington/Locke (2017), [CC BY-NC 3.0](#), Open Genetics Lectures

Reference

Deyholos, M., Harrington, M., & Locke, J. (2017). Figures: 4. Relationship between genotype and phenotype...; and 5. Reciprocal crosses involving an X-linked gene [digital image]. In Locke, J., Harrington, M., Canham, L. and Min Ku Kang (Eds.), *Open Genetics Lectures, Fall 2017* (Chapter 20, p. 3). Dataverse/ BCcampus. http://solr.bccampus.ca:8001/bcc/file/7a7b00f9-fb56-4c49-81a9-cfa3ad80e6d8/1/OpenGeneticsLectures_Fall2017.pdf

Professor Dave Explains. (2020, March 11). Inheritance of X-linked genes (video file). YouTube. <https://www.youtube.com/watch?v=IShS60Azqjg>

Long Descriptions

- **Figure 10.4.1** Relationship between genotype and phenotype for the white gene on the X-linked gene in *Drosophila melanogaster*. The Y chromosome is indicated with a capital Y because it does not have a copy of the white gene. This particular trait (eye colour) is sex-linked in *Drosophila*. [Back to [Figure 10.4.1](#)]
- **Figure 10.4.2** Reciprocal crosses involving an X-linked gene in *Drosophila melanogaster*. In the first cross (left), all offspring have red eyes. In second (reciprocal) cross (right), all female offspring have red eyes and male offspring all have white eyes. If the F1 progeny are crossed (to make the P2), the F2 progeny will be different in each cross. The first cross has all red-eyed females and half red-eyed males. The reciprocal cross has half red-eyed males and females. [Back to [Figure 10.4.2](#)]

10.5 Y-Linked Genes

In humans, the Y chromosome has been studied and is known to contain approximately 200 genes which provide instructions for making proteins. Because only males have the Y chromosome, the genes on this chromosome tend to be involved in male sex determination and development. Sex is determined by the SRY gene, which is the **sex-determining region** of the Y-chromosome.

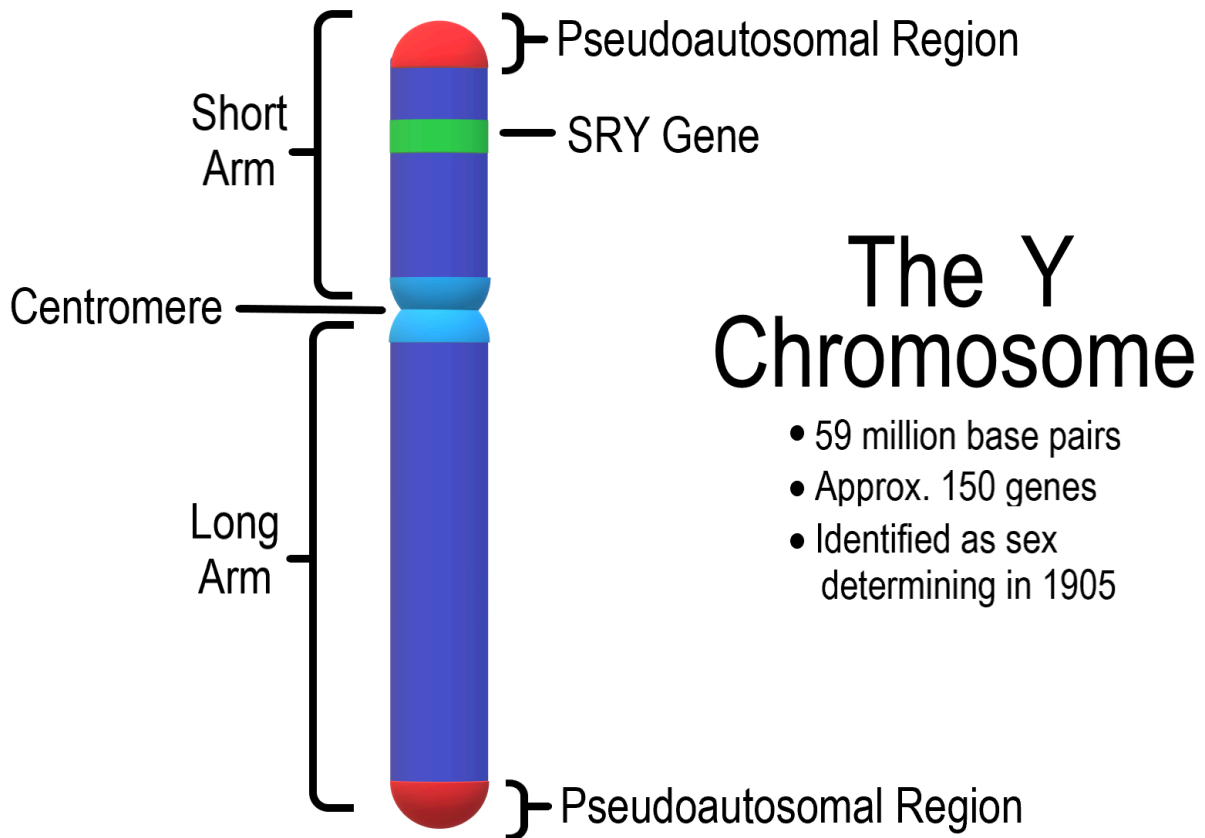

Figure 10.5.1 Structure of the Y-Chromosome in Humans [\[Long description\]](#)

Other genes on the Y chromosome are important for enabling men to father biological children (male fertility). Many genes are unique to the Y chromosome, but genes in areas known as pseudoautosomal regions are present on both sex chromosomes. As a result, men and women each have two functional copies of these genes. Many genes in the pseudoautosomal regions are essential for normal development. Although the Y-chromosome is sex-determining in humans and some other species, not all genes that play a role in sex determination are Y-linked.

Y-linked traits, while few in number, do exist. For instance, the Y-linked trait of “webbed toes” causes a web-like connection between second and third toes, and “porcupine man” occurs when the skin thickens and gradually becomes darker, scaly, rough, and with bristle-like outgrowths. Since Y-linked inheritance involves the Y chromosome, Y-linked inheritance is passed on from father to son. Of course, Y-linked traits never occur in females, and occur in all male

descendants of an affected male. The concepts of dominant and recessive do not apply to Y-linked traits, as only one allele (on the Y) is ever present in any one (male) individual (this, is of course, ignoring XYY syndrome, which is a rare chromosomal disorder that affects males. It is caused by the presence of an extra Y chromosome. Males normally have one X and one Y chromosome. However, individuals with this syndrome have one X and two Y chromosomes).

Take a look at the video, *Sex determination by the Y chromosome*, by Genetics/ UC Davis (2017) on YouTube, which looks at sex determination by the Y-chromosome.

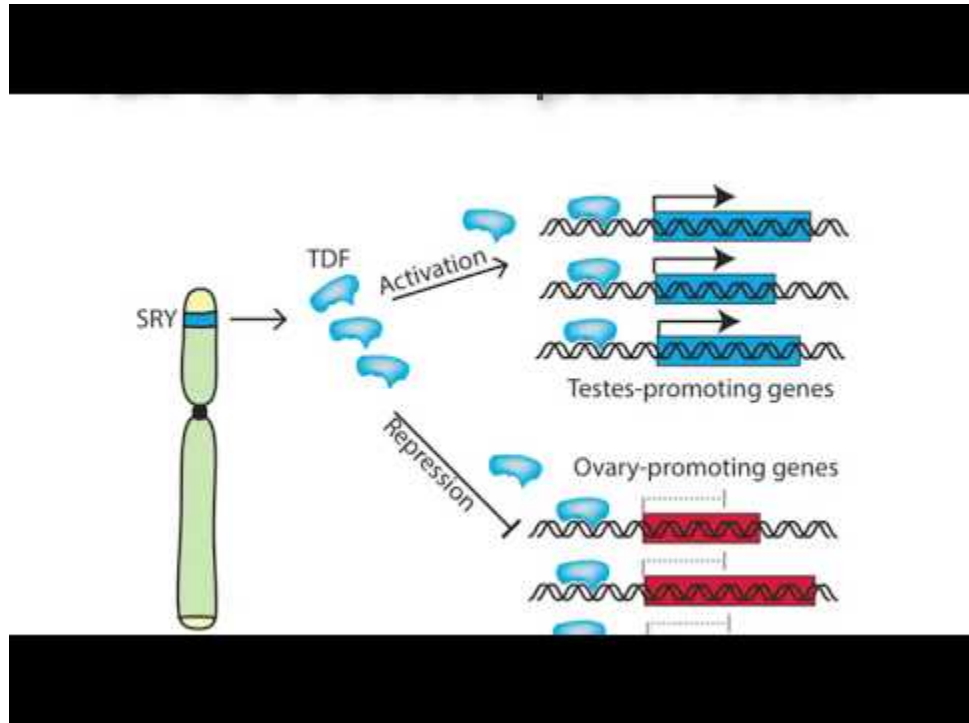

A YouTube element has been excluded from this version of the text. You can view it online here:

<https://opengenetics.pressbooks.tru.ca/?p=1007>

Media Attribution

- **Figure 10.5.1 Y Chromosome** by Christinelmiller, [CC BY-SA 4.0](https://creativecommons.org/licenses/by-sa/4.0/), via Wikimedia Commons

Reference

Genetics/ UC Davis (2017, December 31). Sex determination by the Y chromosome (video file). YouTube.

https://www.youtube.com/watch?v=Fd31_gaRyME

Long Description

- **Figure 10.5.1** The structure of the Y-chromosome in humans shows pseudoautosomal regions at the ends, the position of the centromere, the short arm, which contains the loci for the SRY gene – the sex-determining region of the Y-chromosome, and the long arm. The Y chromosome contains approximately 59 million base pairs, and carries approximately 150 genes, and was identified as a sex chromosome in 1905. [[Back to Figure 10.5.1](#)]

Chapter 10 Summary

The topics covered in this chapter can be summarized as follows:

- Autosomes and sex chromosomes differ in that the former exist in pairs but the latter depends on the sex of the chromosome.
- Pseudo-autosomal regions are regions on X and Y chromosome that can pair up and recombine.
- Sex-linked genes are an exception to standard Mendelian inheritance. Their phenotypes are influenced by the type of sex chromosome system and the type of dosage compensation system found in the species.
- Some of the examples of sex-linked genes are: *white* gene on the *Drosophila*'s X chromosome, *TDF* gene on Y chromosome, *E/e* gene on Z chromosome (birds).

For further interest, take a look at this video, *X-Linked Genes: Patterns of Inheritance* by Oxford Academic (Oxford University Press, 2017) on YouTube.

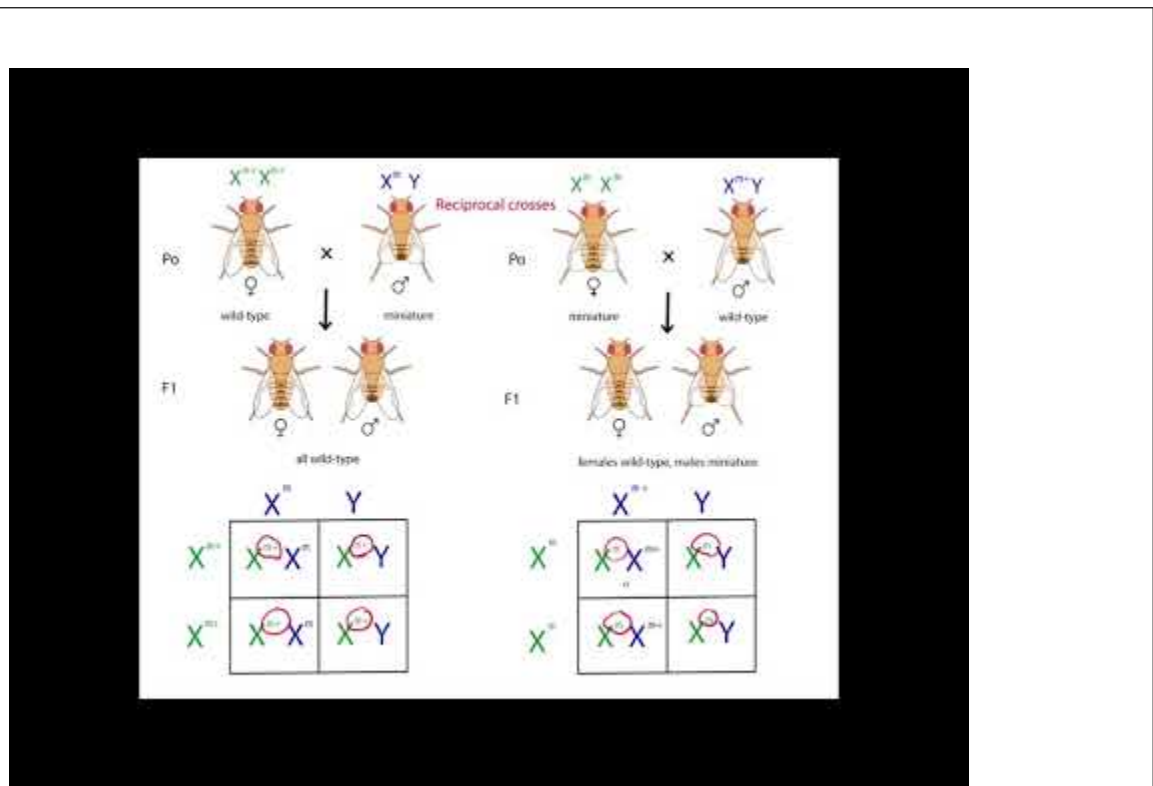

A YouTube element has been excluded from this version of the text. You can view it online here:

<https://open.genetics.pressbooks.tru.ca/?p=1018>

Reference

Oxford Academic (Oxford University Press). (2017). *X-linked genes: Patterns of inheritance* (video file). YouTube. <https://www.youtube.com/watch?v=WNEoT7KhQPI>

Key Terms in Chapter 10

Key Terms – Sex Chromosomes & Sex Linkage

- autosome
- heterogametic
- heteromorphic
- homogametic
- pseudoautosomal regions
- reciprocal cross
- sex chromosome
- sex-linked
- X-linked genes

Chapter 10 Study Questions

1. A rare dominant mutation causes a neurological disease that appears late in life in all people that carry the mutation. If a father has this disease, what is the probability that his daughter will also have the disease?
2. Construct Punnett Squares to accompany the crosses shown in **Figure 10.4.2**.
3. Draw reciprocal crosses that would show that the turkey E-gene is on the Z-chromosome.

Some extra reading and other activities!

4. Read “[The Y chromosome is disappearing – so what will happen to men?](#)” a 2018 article published in *The Conversation* by Darren Griffin and Peter Ellis from the University of Kent. It provides a discussion about the rate of disappearance of the Y-chromosome in the human genome. Also, take a look at the following animation video on YouTube, [Recombination of the Y Chromosome | HHMI BioInteractive Video](#), which relates to this article.
5. Visit the HHMI [Sex Verification Testing of Athletes](#) interactive, by BioInteractive. Relate this back to crossing over in meiosis (In [Recombination of the Y Chromosome | HHMI BioInteractive](#) Video on YouTube).

References

Griffin, D., Ellis, P. (2018, January 17). The Y chromosome is disappearing – so what will happen to men. *The Conversation* (accessed January 11, 2021). <https://theconversation.com/the-y-chromosome-is-disappearing-so-what-will-happen-to-men-90125>

HHMI BioInteractive. (2018, November 29). Recombination of the Y chromosome | HHMI BioInteractive video (video file). YouTube. https://www.youtube.com/watch?v=nIBPBM2z3Kg&feature=emb_logo

HHMI BioInteractive. (n.d.). Sex verification testing of athletes [interactive]. HHMI BioInteractive (accessed January 11, 2021) <https://www.biointeractive.org/classroom-resources/sex-verification-testing-athletes>

Chapter 10 Answers

- It depends on the chromosomal location of the disease locus. If the gene is autosomal, the probability is 50%. If it is sex-linked, that is on the X-chromosome, it would be 100%. If it is Y-linked, then 0%. In both situations the probability would decrease if the penetrance was less than 100%.

Cross (a)

♂ \ ♀	W^+	W^+
W^+	W^+/W^+ red eyed female	W^+/W^+ red eyed female
Y	W^+/Y red eyed male	W^+/Y red eyed male

Cross (b)

♂ \ ♀	W^+	W^+
W^+	W^+/W^+ red eyed female	W^+/W^+ red eyed female
Y	W^+/Y white eyed male	W^+/Y white eyed male

2.

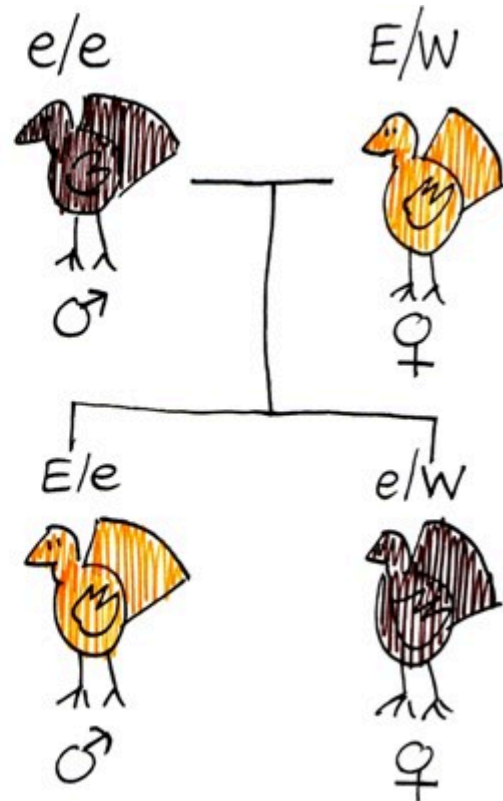
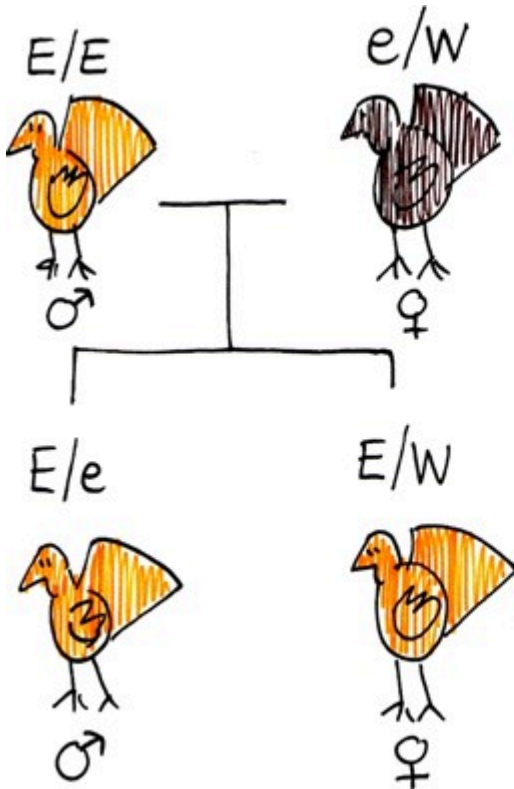

3.

CHAPTER _{II} - RECOMBINATION MAPPING OF GENE LOCI

11.1 Introduction

Learning Objectives

- Construct a “genetic map” using appropriate data.
- Perform gene mapping utilizing recombination frequencies.
- Appreciate that double crossover events lead to an underestimation of map distance.
- Use three-point test crosses to map three linked genes.
- Calculate the coefficient of coincidence and interference.

In this chapter, we will take a step back and look at the bigger picture of genes and chromosomes. “Genetic mapping”, otherwise known as “linkage mapping”, supplies geneticists with the evidence that a trait or disease which is passed from one generation to the next is linked to one or more genes. In addition, genetic maps also provide information regarding which chromosome contains the gene in question and where the gene lies on that chromosome. We will examine the use of recombination frequency (RF) data in constructing genetic maps (**Figure 11.1.1**), and also discuss the limitations of this technique based on events which occur during meiosis. We have already investigated the relative location of two loci by using the frequency of **recombinants** vs **parentals** to determine the recombinant frequency (RF). Two loci could show **independent assortment (unlinked, RF~50%)** or partial **linkage (RF<~35%)**. If linked, the two genes must be located on the same chromosome (**syntenic**), but if unlinked they could be far apart on the same chromosome or on different chromosomes (**non-syntenic**). In this chapter, we will learn how to construct genetic maps using both 2-point crosses and 3-point crosses.

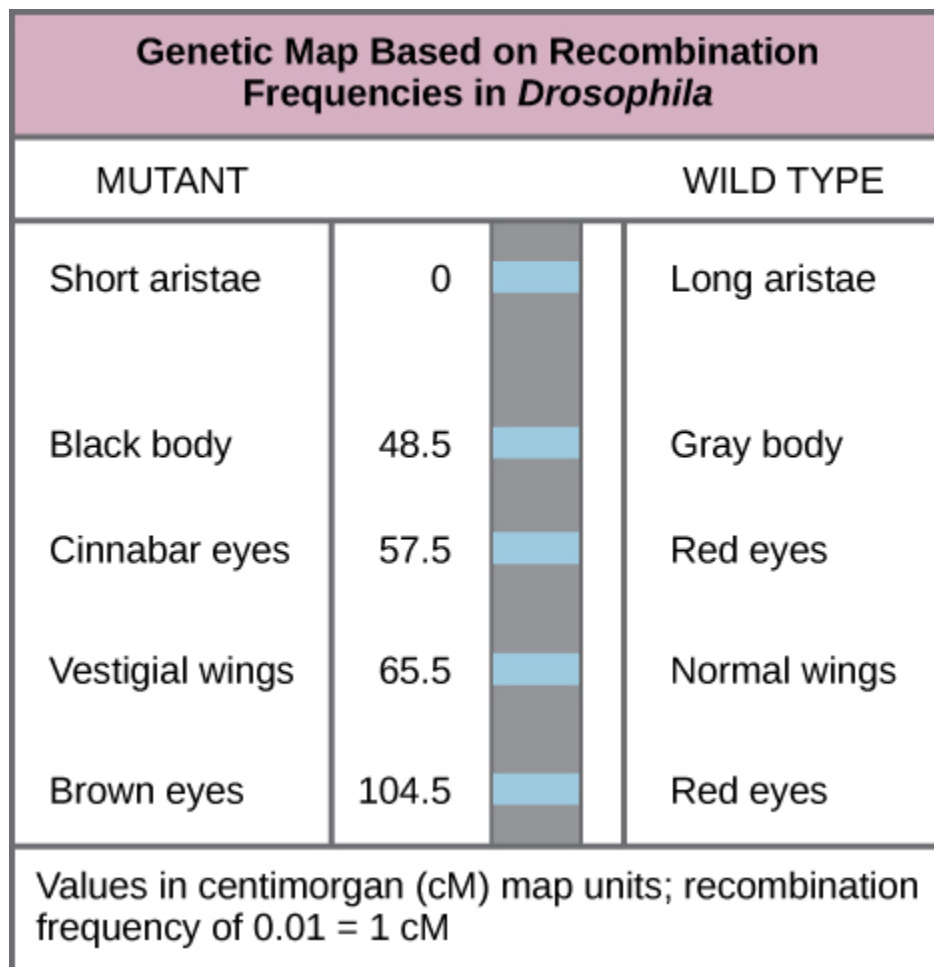

Figure 11.1.1 An Example of a Genetic Map Based on RF's in the Fruit Fly [[Long description](#)]

Media Attribution

- **Figure 11.1.1** [Figure 13 01 03](#) by Rye et al. (2016), [CNX OpenStax](#), [CC BY 4.0](#), via Wikimedia Commons

References

Rye, C. et al. (2016, October 21). Figure 13.4 This genetic map orders *Drosophila* genes on the basis of recombination frequency [digital image]. In *OpenStax Biology*. <https://openstax.org/books/biology/pages/13-1-chromosomal-theory-and-genetic-linkage>

Long Description

- **Figure 11.1.1** Example of a genetic map based on recombination frequencies in the fruit fly. Differences between

phenotypes in the mutant and wildtype are shown for the trials being mapped. For instance, arista length is short in the mutant, but long on the wild type. Body colour is black in the mutant but grey in the wild-type. The map units are provided in centimorgans (cM), whereby a recombination frequency of 0.01 corresponds to 1 centimorgan. [[Back to Figure 11.1.1](#)]

11.2 Genetic Mapping

A **genetic map** (or recombination map) is a representation of the linear order of genes (or loci), and their relative distances determined by crossover frequency, along a chromosome. The fact that such linear maps can be constructed supports the concept of genes being arranged in a fixed, linear order along a single duplex of DNA for each chromosome. We can use recombination frequencies to produce genetic maps of all the loci along each chromosome and ultimately in the whole genome.

Calculating Map Distance

We previously discussed the concept of **linkage**, and we have looked at the process by which we calculate **recombination frequencies**. Now, we would like to combine these two concepts to construct **genetic maps**. A genetic map shows the relative location of two or more genetic traits. Usually, we analyze the offspring in a particular cross, and track how many times two given genetic traits are inherited together; for instance, eye color and wing shape. The higher the percentage of progeny that inherit both traits together, the closer the genes responsible for the traits are on the chromosome. So, genetic maps are based on rates of recombination (physical maps are based on physical distances, which we will look at in [Chapter 12](#)). **Figure 11.2.1** shows a typical genetic map, giving the relative distances between and among various genes in the moth, *Bombyx*.

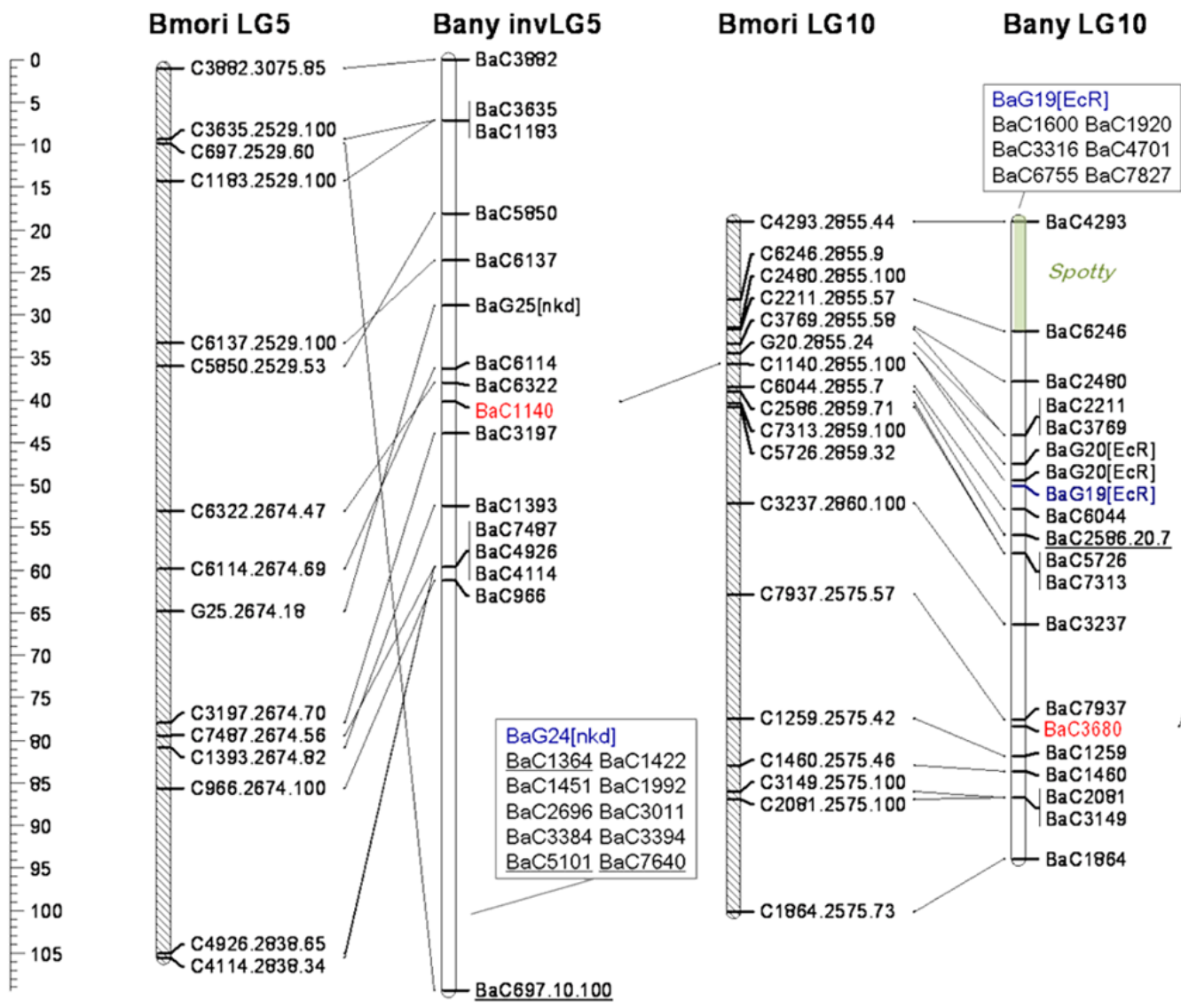

Figure 11.2.1 Genetic Maps for Regions of Two Chromosomes from Two Species of the Moth, *Bombyx*. The scale at left shows distance in cM, and the position of various loci is indicated on each chromosome. Diagonal lines connecting loci on different chromosomes show the position of corresponding loci in different species. This is referred to as regions of conserved synteny. [Long description]

The units of genetic distance are called **map units (mu)** or **centiMorgans (cM)**, in honor of **Thomas Hunt Morgan** by his undergraduate student, **Alfred Sturtevant**, who developed the concept of genetic maps. Geneticists routinely directly convert the recombination frequencies of two loci into cM. Thus, the recombination frequency in per cent is approximately the same as the map distance in cM. One map unit is equal to a 1% recombination rate. Gene maps that you create based on experimental data will look a lot more like **Figure 11.2.2** (and less like **Figure 11.2.1!**).

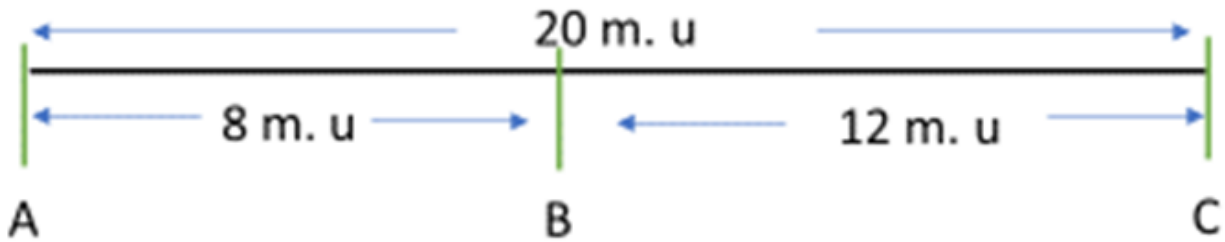
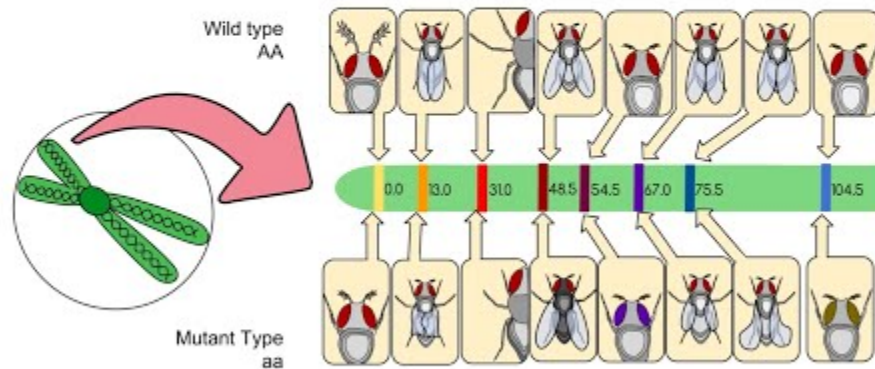

Figure 11.2.2 This Gene Map Shows the Relative Distances Amongst Three Genes, A, B and C. [[Long description](#)]

Genetic distances measured with recombination rates are also approximately additive – so if we take the gene map shown in Figure 11.3, the distance between gene A to B is 8 m.u. and from B to C is 12 m.u. – therefore, the distance between A and C is 20 m.u. and gene B is located between genes A and C. Note, however, this approximation works well only for small distances (RF<30%) but progressively fails at longer distances. This is because as the two loci get farther apart the RF reaches a maximum at 50%, like it would for two loci assorting independently (not linked). In fact, some chromosomes are >100 cM long but such loci at the tips only have an RF of 50%. Calculating the map distance of the whole chromosome (end-to-end) of over 50 cM comes from mapping of multiple loci dispersed along the chromosome, each with a value of less than 50%, with their total adding up to the value over 50 cM (e.g., >100 cM as above). The method for mapping of these long chromosomes is described next. Note that the map distance of two loci alone does not tell us anything about the orientation of these loci relative to other features, such as centromeres or telomeres, on the chromosome.

Take a look at the video, *Gene Linkage and Genetic Maps*, by Professor Dave Explains (2020) on YouTube.

Sturtevant and his colleagues were able to map many of the **fruit fly genes** in this way



A YouTube element has been excluded from this version of the text. You can view it online here:

<https://opengenetics.pressbooks.tru.ca/?p=1046>

Map Distance Over Long Chromosomes

Map distances are always calculated for one pair of loci at a time. However, by combining the results of multiple pairwise calculations, a **genetic map** of many loci on a chromosome can be produced (**Figure 11.2.2**). A genetic map shows the map distance, in cM, that separates any two loci, and the position of these loci relative to all other mapped loci. The genetic map distance is roughly proportional to the physical distance, i.e., the amount of DNA between two loci. For example, in *Arabidopsis*, 1.0 cM corresponds to approximately 150,000 bp and contains approximately 50 genes. The exact number of DNA base pairs in a cM depends on the organism, and on the position in the chromosome. Some parts of chromosomes (“crossover hot spots”) have higher rates of recombination than others, while other regions have reduced crossing over and often correspond to large regions of heterochromatin. When a novel gene or locus is identified by mutation or polymorphism, crossing it with previously mapped genes, and then calculating the recombination frequency can determine its approximate position on a chromosome. If the novel gene and the previously mapped genes show complete or partial linkage with an existing locus, the recombination frequency will indicate the approximate position of the novel gene within the genetic map. This information is useful in isolating (i.e., cloning) the specific fragment of DNA that encodes the novel gene. This process called **map-based cloning**. Genetic maps are also useful to (1) track genes/alleles when breeding crops and animals, (2) in studying evolutionary relationships between species, and (3) in determining the causes and individual susceptibility of some human diseases.

Genetic Maps are an Approximation

Genetic maps are useful for showing the order of loci along a chromosome, but the distances are only a relative approximation. The correlation between recombination frequency and actual chromosomal distance is more accurate for short distances (low RF values) than long distances. Observed recombination frequencies between two relatively distant markers tend to underestimate the actual number of crossovers that occurred. This is because as the distance between loci increases, so does the possibility of a second (third, or more) crossover occurring between the loci. This is a problem for geneticists, because with respect to the loci being studied, these **double-crossovers** produce gametes with the same genotypes as if no recombination events had occurred (**Figure 11.2.3**), so they have parental genotypes. Thus, a double crossover will appear to be a parental type and not be counted as a recombinant, despite having two (or more) crossovers. Geneticists may use specific mathematical formulae to adjust large recombination frequencies to account for the possibility of multiple crossovers, and thus get a better estimate of the actual distance between two loci.

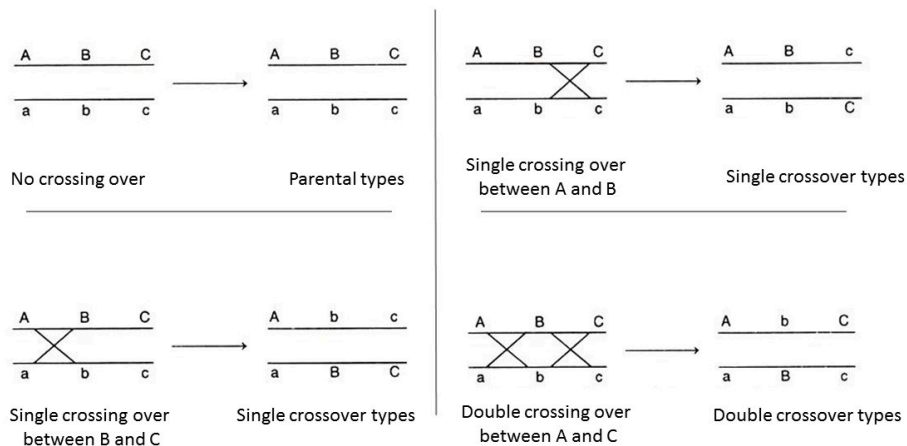

Figure 11.2.3 A Double Crossover Between Two Loci Will Produce Gametes with Parental Genotypes, Even Though TWO Crossovers Have Occurred Between the Loci. [[Long description](#)]

Media Attributions

- **Figure 11.2.1 Figure 3** attributed to [NCBI-NIH](#) (2017), public domain, Open Genetics Lectures, modified from [original](#) from Beldade et al (2009).
- **Figure 11.2.2** by N. Ramroop Singh
- **Figure 11.2.3** by N. Ramroop Singh

References

Beldade, P., Saenko, S. V., Pul, N., Long, A. D. (2009, February). Figure 3. A gene-based linkage map for bicyclus anynana butterflies allows for a comprehensive analysis of synteny with the lepidopteran reference genome [digital image]. *PLOS Genetics* 5(2): e1000366. <https://doi.org/10.1371/journal.pgen.1000366.g003>

NCBI-NIH (2017). Figure 3. Genetic maps for regions of two chromosomes...[digital image]. In Locke, J., Harrington, M., Canham, L. and Min Ku Kang (Eds.), *Open Genetics Lectures, Fall 2017* (Chapter 19, p. 2). Dataverse/ BCcampus. http://solr.bccampus.ca:8001/bcc/file/7a7b00f9-fb56-4c49-81a9-cfa3ad80e6d8/1/OpenGeneticsLectures_Fall2017.pdf

Professor Dave Explains. (2020, March 18). Gene linkage and genetic maps (video file). YouTube. <https://www.youtube.com/watch?v=wrtLyLwt5lo>

Long Descriptions

- **Figure 11.2.1** Genetic maps for regions of two chromosomes from two species of the moth, *Bombyx*. The scale at left shows distance in cM, and the position of various loci is indicated on each chromosome. Diagonal lines connecting loci on different chromosomes show the position of corresponding loci in different species. This is referred to as regions of conserved synteny. [Back to [Figure 11.2.1](#)]
- **Figure 11.2.2** A typical and simple gene map shows the relative distances among three genes, A, B and C. The distance between genes A and B is shown as 8 map units, the distance between genes B and C is shown as 12 map units, and therefore the distance between genes A and C is 20 map units. Gene B is located between genes A and C. [Back to [Figure 11.2.2](#)]
- **Figure 11.2.3** Representation of the gametes that result when crossing over does not occur, or when one cross over occurs between non-sister chromosomes of a homologous pair – versus when a double crossover occurs between non-sister chromatids of a homologous pair. With single cross overs, recombinant genotypes are obtained, but with double cross overs, no recombinant genotypes are produced – only parental. Even though two crossovers have occurred, they cancel each other out, leading to only parental genotypes. [Back to [Figure 11.2.3](#)]

11.3 Two-Point and Three-Point Crosses

Gene maps can be created by using the information obtained through a series of test crosses, whereby one of the parents is heterozygous for a different pair of genes and we can calculate the recombination frequencies between pairs of genes. A test cross between two genes is called a **two-point test cross**. Let us explore a worked example which will demonstrate how we are able to gene map using recombination frequencies. First, we will look at **two-point test crosses**, then we will investigate **three-point test crosses**, which are generally more accurate.

Two-Point Crosses

A scientist conducted a sequence of two-point crosses for four genes, q, r, s and t, and the following recombination frequencies were obtained, as shown in Table 11.3.1

Table 11.3.1 Recombination Frequencies for a Sequence of Two-Point Crosses for Four Genes (q, r, s & t)

Gene loci	RF (%)
q and r	50
q and s	50
q and t	50
r and s	20
r and t	10

When independent assortment is occurring, we have RF = 50%. So, we can deduce that genes q and r are either located on different chromosomes or are very distant from each other on the same chromosome. They are hence considered to belong to different **linkage groups**. By the same virtue, q and s are also in different linkage groups, as are q and t. Now, the RF between r and s is 20%, so these genes are separated by 20 map units. Genes r and t are also linked, with an RF of 10%. To determine if gene t is 10 m.u. to the right or left of gene r, we look at the s-t distance. If t is 10 m.u. to the left of r, then the distance between t and s should be approximately the sum of the distance between r and s and between s and t: $(20 \text{ m.u.} + 10 \text{ m.u.}) = 30 \text{ m.u.}$. [Note: this distance is an approximation due to “double crossovers” occurring]. Now, the other possibility is that gene t is located to the right of gene r, and in that case, the distance between gene t and s will be less (approximately $20 \text{ m.u.} - 10 \text{ m.u.} = 10 \text{ m.u.}$). We see from the data that the R.F. between s and t is 28%, so the t lies to the left of r. So, we can draw the genetic map as shown in **Figure 11.3.1**.

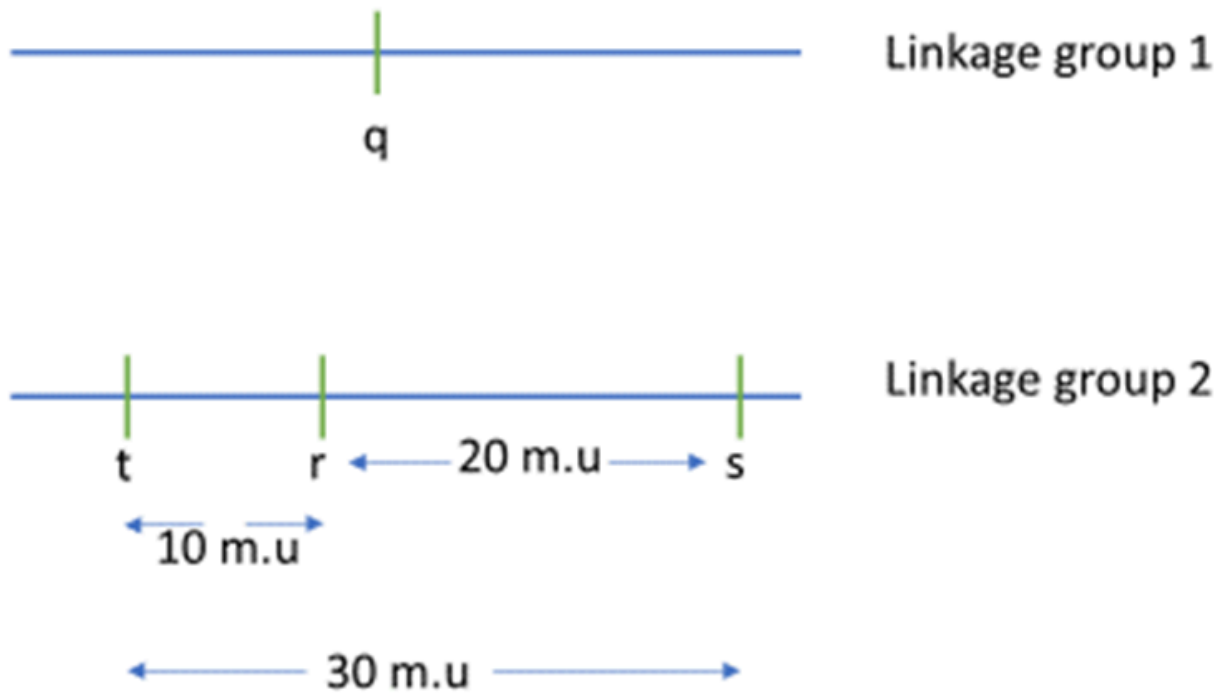
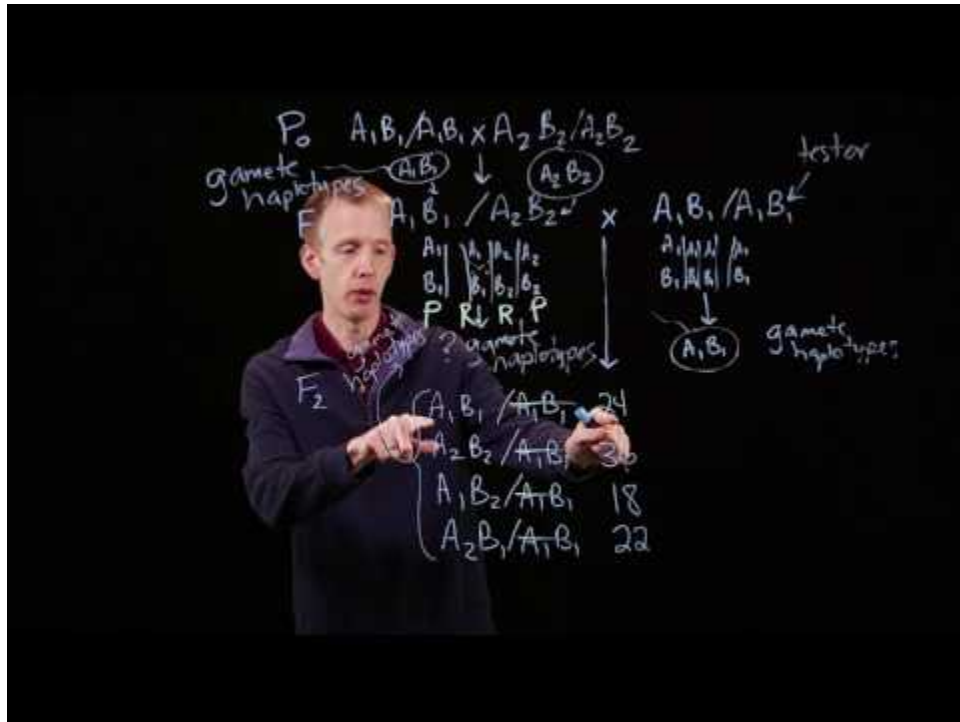

Figure 11.3.1 Genetic Map Based on Data Obtained From Two-Point Crosses in **Table 11.3.1**. [[Long description](#)]

Watch the following video, *Genetic Distance and Two-Point Mapping*, by Joseph Ross (2017) on YouTube.



A YouTube element has been excluded from this version of the text. You can view it online here:

<https://opengenetics.pressbooks.tru.ca/?p=1056>

Next, take a look at the video below, *Gene Mapping, Percent Recombination and Map Units*, by AK Lectures (2015) on YouTube, for another worked example of gene mapping using % recombination.

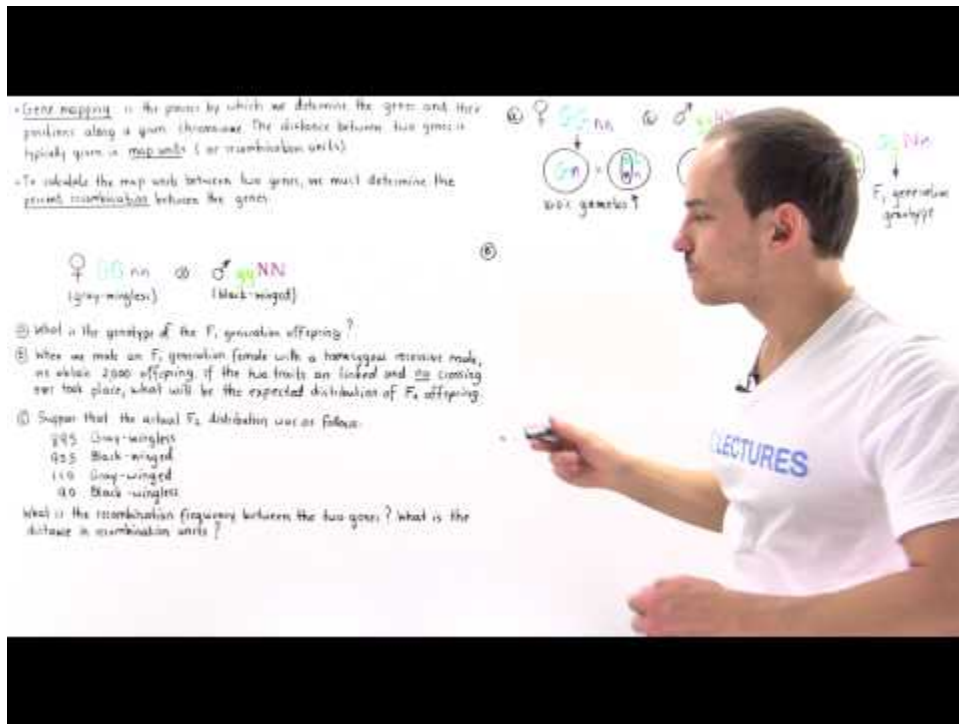

A YouTube element has been excluded from this version of the text. You can view it online here:

<https://opengenetics.pressbooks.tru.ca/?p=1056>

Three-Point Crosses

We see that a two-point test cross is a method to estimate gene distances in map units using recombination frequency data. We also mentioned that the occurrence of **double crossovers** causes an underestimation of map distances. Generally, the larger the recombinant frequency, the less accurate it is as a measure of map distance. In fact, map units calculated from larger recombinant frequencies are actually smaller than map units calculated from smaller recombinant frequencies. Typically, when measuring recombination between three linked loci, the sum of the two internal recombinant frequencies is greater than the recombinant frequency between the outside loci. The best estimates of map distance are obtained from the sum of the distances calculated for shorter sub-intervals. Refer to **Figure 11.2.3** which demonstrates “a double crossover” and shows only the middle gene being altered in such cases, vs. the results with single crossovers. A genetic map consists of multiple loci distributed along a chromosome. A particularly efficient method of mapping three genes at once is the **three-point cross**, which allows the order and distance between three potentially linked genes to be determined in a single cross experiment (**Figure 11.3.2**).

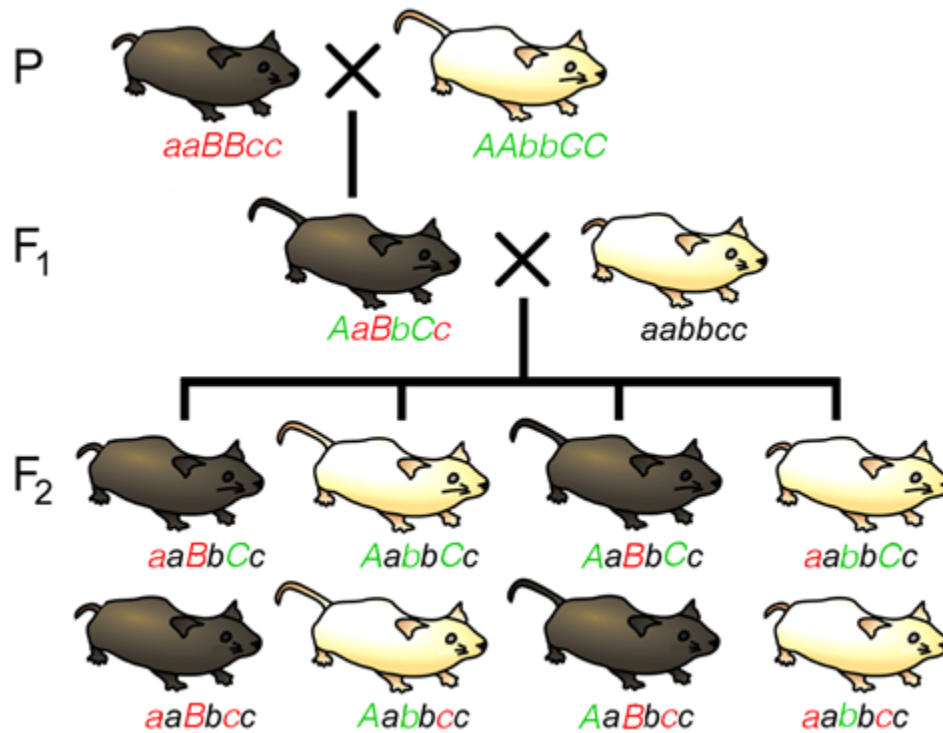

Figure 11.3.2 A Three-Point Cross for Loci Affecting Tail Length, Fur Colour, and Whisker Length
[\[Long description\]](#)

This is particularly useful when mapping a new mutation for which the location is unknown relative to two previously mapped loci with known locations. The basic strategy is the same as for the dihybrid mapping experiment described previously, except pure breeding lines with contrasting genotypes are crossed to produce an individual heterozygous at three loci (a trihybrid), which is then test-crossed to a tester, which is homozygous recessive for all three genes, to determine the recombination frequency between each pair of genes, among the three loci. A Punnett square can be used to predict all the possible outcomes of the test cross (**Figure 11.3.3**). The progeny produced from the test cross is shown in **Table 11.3.2**.

	aBC	P2 AbC	abC	ABC	P1 aBc	Abc	abc	ABc
	abc	aa Bb Cc	Aa bb Cc	aa bb Cc	Aa Bb Cc	aa Bb cc	Aa bb cc	aa bb cc
phenotype	Short tail Brown Long whis	Long tail White Long whis	Short tail White Long whis	Long tail Brown Long whis	Short tail Brown Short whis	Long tail White Short whis	Short tail White Short whis	Long tail Brown Short whis

Figure 11.3.3 Punnett Square of the Test Cross for **Figure 11.3.2**, Showing the Predicted Gametes Possible from this Cross, and the Resulting Phenotypes [\[Long description\]](#)

Table 11.3.2 An Example of Data that Might be Obtained from the F₂ Generation of the Three-Point Cross is Shown in Figure 11.3.2. The rarest phenotypic classes correspond to double recombinant gametes *ABc* and *abC*. Each phenotypic class and corresponding gamete can also be classified as parental (P) or recombinant (R) with respect to how each pair of loci (A,B), (A,C), (B,C) are arranged on the chromosome.

tail phenotype	fur phenotype	whisker phenotype	number of progeny n=120	gamete from trihybrid	genotype of F ₂ from test cross	loci A, B	loci A, C	loci B, C
short	brown	long	5	aBC	aaBbCc	P	R	R
long	white	long	38	AbC (P2)	AabbCc	P	P	P
short	white	long	1	abC	aabbCc	R	R	P
long	brown	long	16	ABC	AaBbCc	R	P	R
short	brown	short	42	aBc (P1)	aaBbcc	P	P	P
long	white	short	5	Abc	Aabbcc	P	R	R
short	white	short	12	abc	aabbcc	R	P	R
long	brown	short	1	ABc	AaBbcc	R	R	P

When the trihybrid is crossed to a tester, it should be able to make eight different gametes, to make eight possible different phenotype combinations in the offspring. The next step would be to identify if the alleles are recombinant or parental gametes. This can be done by comparing only two loci at one time to the parental gametes. In this example, the parents of the trihybrid are *a/a B/B c/c*, and *A/A b/b C/C*, so the parental gametes would be *aBc* and *AbC* respectively. Now, by comparing two loci at once you can determine if, between the two, they are recombinant or parental. For example, the offspring in the first row in **Table 11.3.2** came from gamete *aBC*. Comparing loci A and B, we see that it matches one of the parental gametes and, therefore, it is parental. Comparing A and C, we see that it matches neither parental – so it is recombinant. The same can be said for comparing B and C.

$$\text{RF}_{\text{loci A,B}} = \frac{(1+16+12+1)}{120} = \frac{30}{120} = 25\%$$

$$\text{RF}_{\text{loci A,C}} = \frac{(1+5+1+5)}{120} = \frac{12}{120} = 10\%$$

$$\text{RF}_{\text{loci B,C}} = \frac{(5+15+12+5)}{120} = \frac{38}{120} = 32\% \text{ [not corrected for double crossovers]}$$

Once the classes of progeny have been identified, as each pair of locus being parental or recombinant, recombination frequencies may be calculated for each pair of loci individually – as we did before for one pair of loci in our dihybrid cross (Chapter 18). We can then use these numbers to build the map, placing the loci with the largest RF on the ends. However, note that in the three-point cross, the sum of the distances between A-B and A-C (10% + 25% = 35%) is less than the distance calculated for B-C (32%). This is because of **double crossovers** between B and C, which were undetected when we considered only pairwise data for B and C (**Figure 11.3.4**). We can easily account for some of these double crossovers, and include them in calculating the map distance between B and C, as follows.

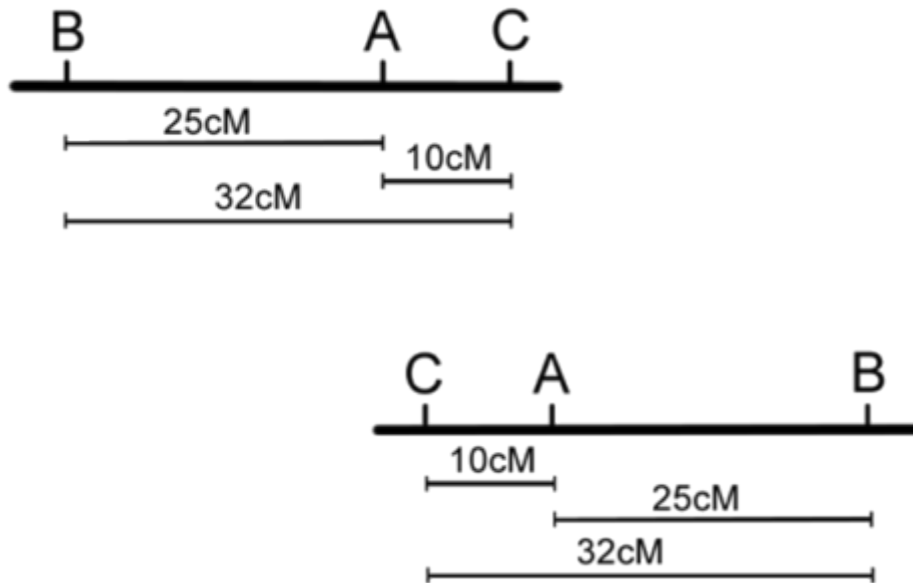

Figure 11.3.4 Two Possible Maps Based on the Data in **Table 11.3.2** (Without Correction for Double Crossovers) [[Long description](#)]

We already deduced that the map order must be BAC (or CAB). However, these double recombinants, ABc and abC , were not included in our calculations of recombination frequency between loci B and C. If we included these double recombinant classes (multiplied by 2, since they each represent two recombination events), the calculation of recombination frequency between B and C is as follows, and the result is now more consistent with the sum of map distances between A-B and A-C.

$$\text{RF}_{\text{loci B,C}} = \frac{(5+16+12+5+2(1)+2(1))}{120} = \frac{42}{120} = 35\% \text{ [corrected for double crossovers]}$$

As such, the three-point cross is useful for:

1. determining the order of three loci relative to each other,
2. calculating map distances between the loci, and
3. detecting some of the double crossover events that would otherwise lead to an underestimation of map distance.

However, it is possible that other, double crossover events remain undetected, for example double crossovers between loci A&B or between loci A&C. Geneticists have developed a variety of mathematical procedures to try to correct for such double crossovers during large-scale mapping experiments. As more and more genes are mapped, a better genetic map can be constructed. Then, when a new gene is discovered, it can be mapped relative to other genes of known location to determine its location. All that is needed to map a gene is two alleles, a wild type allele and a mutant allele. Now that we know what the map looks like, the frequency of each offspring type can be explained. Parental gametes (AbC and aBc) are the result of no crossovers, or double crossovers between two alleles. Because we know all three loci are linked, it is expected for this frequency to be relatively high, much like what we see in the example above. There are recombinant gametes that are the result of one crossover between two alleles (aBC , Abc , ABC and abc). Single crossover events are more common, but are more likely to happen between loci B and A, because they are 25 cM, and as such, are farther apart than A and C, which are only 10 cM. So, we expect to see more recombinant gametes with the former.

And lastly, there are recombinant gametes that are a result of double crossover events (ABc and abC). Double crossovers between three linked genes like this is rare, so we don't expect to see many offspring from these recombinant gametes.

The frequencies we see from this cross agree with our expectations. **Figure 11.3.6** shows a diagram of the crossover events that took place in regard to recombinant gametes and the number of offspring seen with that gamete type.

In the example given above, all the genes present are linked, with one pair more strongly linked than the other (A and C have stronger linkage than A and B). When choosing three genes to map, this will not always be the case. Sometimes, you will have all genes linked. Sometimes, you may have two genes linked and one gene unlinked. And sometimes, they all may be unlinked (**Figure 11.3.5**). Much like what we did above, by comparing the ratios of offspring, you should be able to predict if the genes in the trihybrid are linked or not.

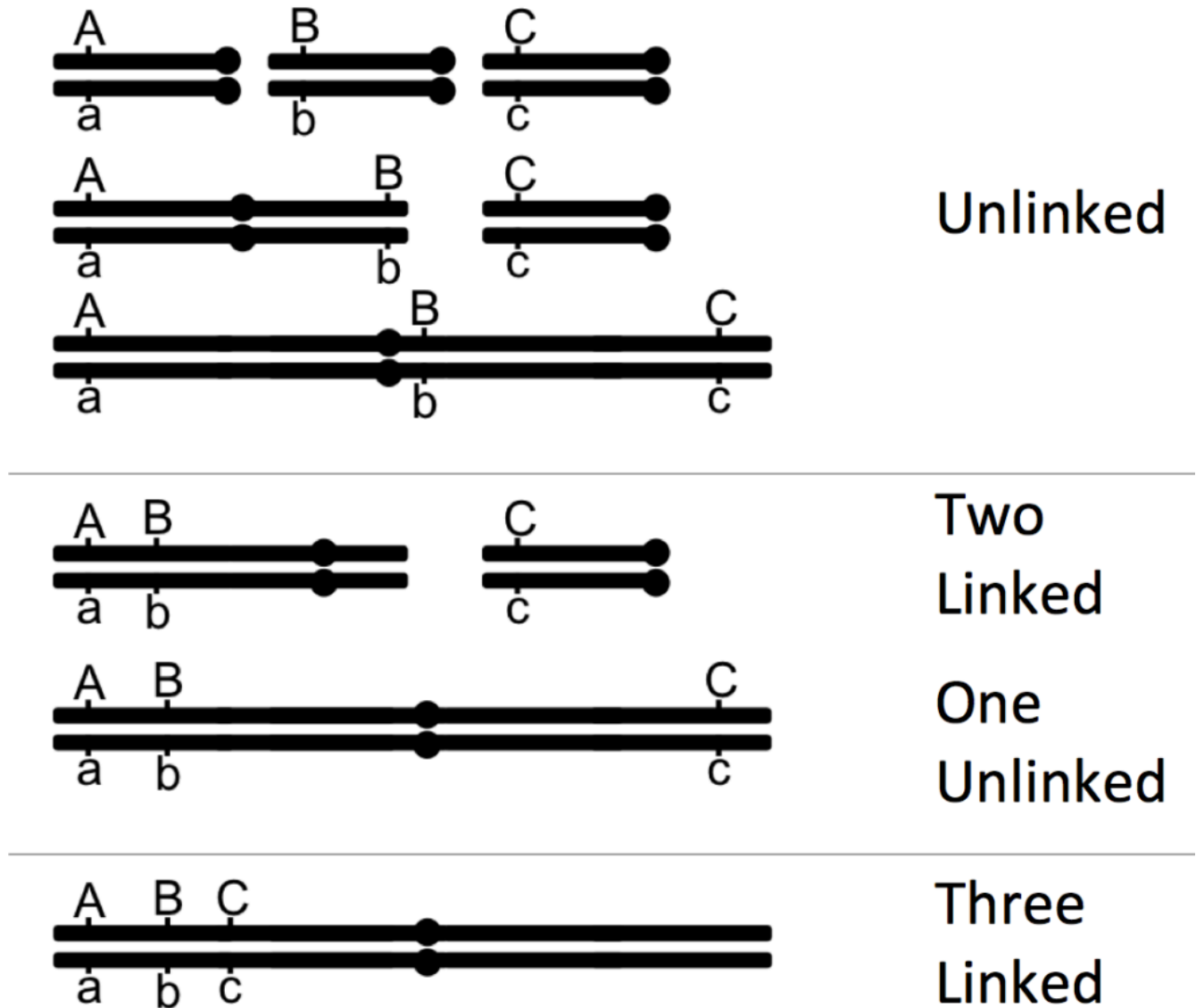
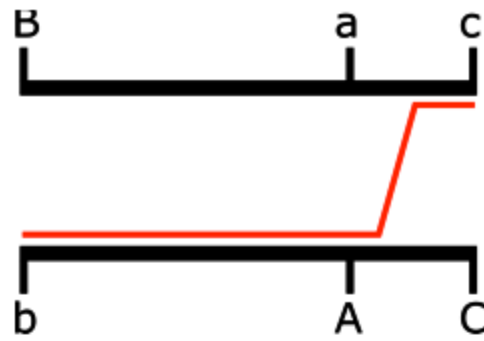
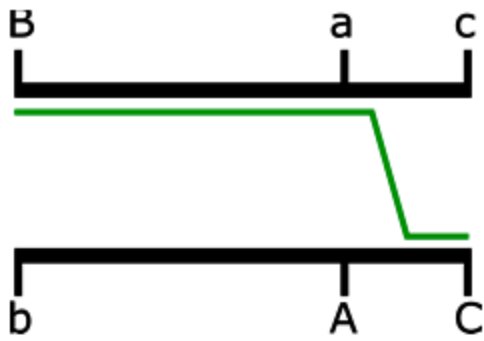

Figure 11.3.5 Examples of How Three Genes can be Associated with Each Other, Based on Whether All Three are Unlinked, All Three are Linked, or Two are Linked and One Unlinked [[Long description](#)]

If all three genes are unlinked, then we expect independent assortment and an equal number of all progeny types. Like

in the example, if all are linked, you expect there to be many parental genotypes, some recombinant genotypes if they are a result of a single recombination events. Recombinant genotypes that are a result of two recombination events will be rare. The actual numbers of each will differ depending if all the linked genes are equal distances from each other, or if one pair is more linked than the other. In the case where two genes are linked and one gene is unlinked, the following applies. As in the example before, we will use the same parental gametes (AbC and aBc), but will assume the genes A and C are linked and B is unlinked. In this case, because linkage causes a higher prevalence of parental gametes, we expect there to be more parental organizations of A and C, and fewer recombinant organizations of A and C. The presence and/or absence of parental B is not important here, because it is unlinked and will assort independently.



gamete	# of progeny	gamete	# of progeny
aBC	5	Abc	5

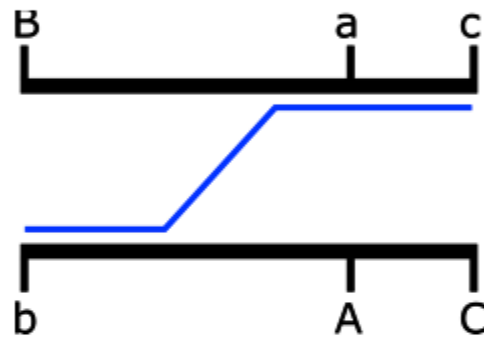
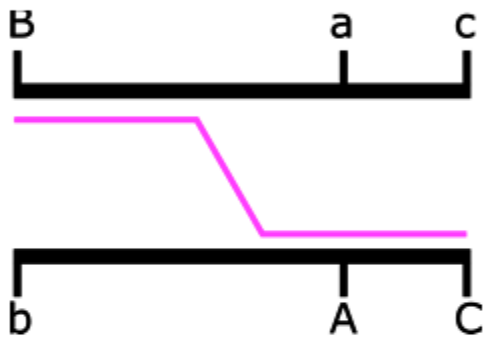

gamete	# of progeny	gamete	# of progeny
ABC	16	abc	12

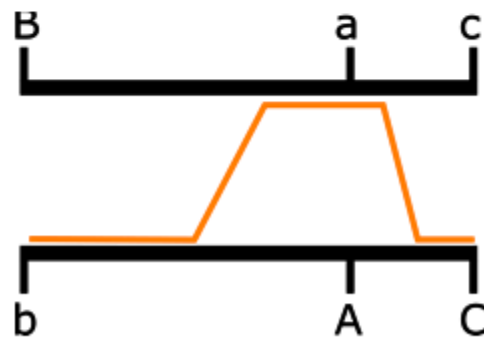
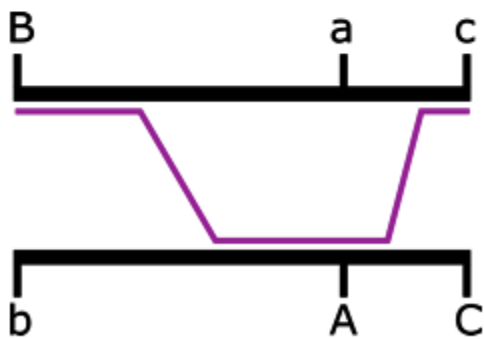

gamete	# of progeny	gamete	# of progeny
ABc	1	abC	1

Figure 11.3.6 Diagram of the Crossover Events to Create the Different Recombinant Gametes from the Cross in **Figure 11.3.2**. The parental alleles are seen on the black chromosomes. The coloured lines indicate where the crossover event took place, and highlight the alleles for that recombinant gamete. Below each diagram is the recombinant gamete and the number of progeny seen in that cross per **Table 11.3.2**. [Long description]

Take a look at the video, *Three-Point Mapping and Gene Order*, by Joseph Ross (2017) on YouTube, which gives a worked example of genetic mapping using three-point test crosses.

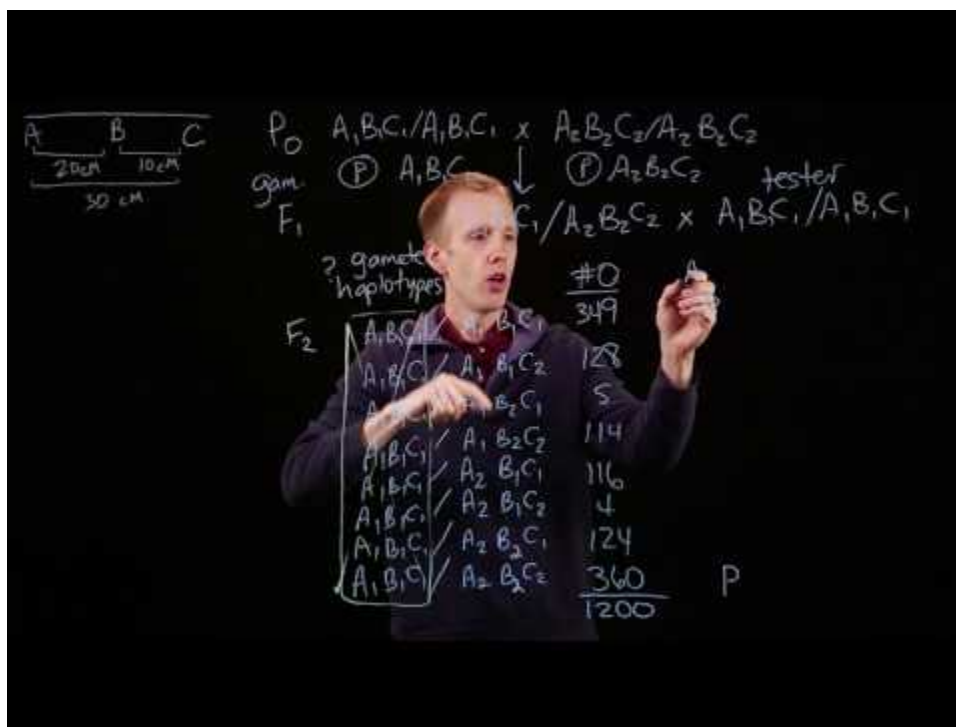

A YouTube element has been excluded from this version of the text. You can view it online here:

<https://opengenetics.pressbooks.tru.ca/?p=1056>

Media Attributions

- **Figure 11.3.1** by N. Ramroop Singh
- **Figure 11.3.2** [Original](#) modified by Deyholos/Locke (2017), [CC BY-NC 3.0](#), Open Genetics Lectures
- **Figure 11.3.3** [Original](#) by L. Canham (2017), [CC BY-NC 3.0](#), Open Genetics Lectures
- **Figure 11.3.4** [Original](#) by Deyholos (2017), [CC BY-NC 3.0](#), Open Genetics Lectures
- **Figure 11.3.5** [Original](#) by J. Locke/L. Canham (2017), [CC BY-NC 3.0](#), Open Genetics Lectures
- **Figure 11.3.6** [Original](#) by L. Canham (2017), [CC BY-NC 3.0](#), Open Genetics Lectures

References

- AK Lectures. (2015, January 9). Gene mapping, percent recombination and map units (video file). YouTube.
<https://youtu.be/asNgHpOuJmY>
- Canham, L. (2017). Figures: 6. Punnett square of the test cross for Figure 5...; and 9. Diagram of the crossover events...[digital image]. In Locke, J., Harrington, M., Canham, L. and Min Ku Kang (Eds.), *Open Genetics Lectures, Fall 2017* (Chapter 19, p. 4; 6). Dataverse/ BCcampus. http://solr.bccampus.ca:8001/bcc/file/7a7b00f9-fb56-4c49-81a9-cfa3ad80e6d8/1/OpenGeneticsLectures_Fall2017.pdf
- Deyholos, M. (2017). Figure 7. Two possible maps based on the...[digital image]. In Locke, J., Harrington, M., Canham, L. and Min Ku Kang (Eds.), *Open Genetics Lectures, Fall 2017* (Chapter 19, p. 4). Dataverse/ BCcampus.
http://solr.bccampus.ca:8001/bcc/file/7a7b00f9-fb56-4c49-81a9-cfa3ad80e6d8/1/OpenGeneticsLectures_Fall2017.pdf
- Deyholos, M., Locke, J. (2017). Figure 5. A three point cross for loci affecting tail length...[digital image]. In Locke, J., Harrington, M., Canham, L. and Min Ku Kang (Eds.), *Open Genetics Lectures, Fall 2017* (Chapter 19, p. 3). Dataverse/ BCcampus. http://solr.bccampus.ca:8001/bcc/file/7a7b00f9-fb56-4c49-81a9-cfa3ad80e6d8/1/OpenGeneticsLectures_Fall2017.pdf
- Joseph Ross. (2017, February 23). Genetic distance and two-point mapping (video file). YouTube.
<https://www.youtube.com/watch?v=5GwvgRNGlFE>
- Joseph Ross. (2017, February 28). Three-point mapping and gene order (video file). YouTube.
<https://www.youtube.com/watch?v=HdIBRYvDUzM>
- Locke, J., Canham, L. (2017). Figure 8. Examples of how three genes can be...[digital image]. In Locke, J., Harrington, M., Canham, L. and Min Ku Kang (Eds.), *Open Genetics Lectures, Fall 2017* (Chapter 19, p. 6). Dataverse/ BCcampus.
http://solr.bccampus.ca:8001/bcc/file/7a7b00f9-fb56-4c49-81a9-cfa3ad80e6d8/1/OpenGeneticsLectures_Fall2017.pdf

Long Descriptions

- **Figure 11.3.1** A genetic map shows the relative location of four genes, q, r, s and t. Gene q is in a linkage group by itself, and as such, is shown on a separate line and labelled Linkage group 1. Genes r, s, and t all belong to the same linkage group, and these are shown on a line labelled Linkage group 2. Gene r can be found between gene t and s. The distance between gene t and r is 10 map units, and the distance between gene r and s is 20 map units. As such, the distance between genes t and s is 30 map units. [Back to [Figure 11.3.1](#)]
- **Figure 11.3.2** A cross showing Parental, F1 and F2 generations, representing a three-point test cross for loci affecting tail length, fur colour, and whisker length. Such a cross can provide information about the order and distance between three potentially linked genes, by providing numbers of recombinant offspring versus non-recombinant offspring. [Back to [Figure 11.3.2](#)]
- **Figure 11.3.3** A Punnett square of the test cross for Figure 11.3.2, showing the predicted gametes possible from this cross, and the resulting phenotypes. Tail length can either be short or long, coat colour can be brown or white, and whiskers can be long or short. The genotypes and phenotypes of the F2 generation are shown, and non-recombinants (parentals) are identified as P 1 and P2. [Back to [Figure 11.3.3](#)]
- **Figure 11.3.4** Two possible maps based on the data in Table 11.3.2 (without correction for double crossovers). Based

on the data obtained from the three-point test cross, gene A lies in-between genes B and C. The distance between genes B and A is 25 centimorgans, the distance between genes A and C is 10 centimorgans, and the distance between genes B and C was found to be 32 centimorgans, because double-crossovers are not accounted for. The order of the genes on this chromosome can either be B-A-C or C-A-B. [Back to [Figure 11.3.4](#)]

- **Figure 11.3.5** Examples of how three genes can be associated with each other, based on whether all three are unlinked, all three are linked, or two are linked and one is unlinked. With genes that are linked, various distances can exist between and among them. Unlinked genes can be on different chromosomes altogether, or on the same chromosome, but far apart. [Back to [Figure 11.3.5](#)]
- **Figure 11.3.6** A diagram of the crossover events to create the different recombinant gametes from the cross in Figure 11.3.2. The parental alleles are shown on black chromosomes. Coloured lines indicate where the crossover event took place, and highlight the alleles for that recombinant gamete. Below each diagram is the recombinant gamete and the number of progeny seen in that cross, as per the information in Table 11.3.2. Using this data, gene maps can be produced. [Back to [Figure 11.3.6](#)]

11.4 Coincidence and Interference

Other than providing information about the relative distances that separate genes, map distances also gives us information regarding the proportions of recombinant and nonrecombinant gametes produced in a cross. A map distance of 7.5 m.u. between two genes indicates that 7.5% of the gametes produced by an organism that is heterozygous at both loci will be recombinant.

Double crossovers, as mentioned previously, cause an underestimation of map distances. If we were to theoretically calculate the proportion of double recombinant gametes using the rule of probability (multiplication), and then multiply this theoretical probability by the total number of progeny, we would obtain the expected number of double crossover progeny. In reality, much less are observed in the progeny produced. This is because the calculated number assumes that each crossover is independent of each other. Crossovers are not independent – one crossover may inhibit other crossovers in the nearby vicinity on the chromosome, so double crossovers become less frequent than expected.

The term **interference** is used to describe the degree to which one crossover interferes with other crossovers in the region at the chromosome in question. We are able to calculate the interference using the following formula:

$$\text{Interference} = 1 - \text{coefficient of coincidence}$$

Now, the coefficient of coincidence can be calculated by the following formula:

$$\text{Coefficient of coincidence} = \frac{\text{Number of observed double crossovers}}{\text{Number of expected double crossovers}}$$

Please visit North Dakota State University's website to read [Genetic Linkage](#), by Phillip McClean (1998), for a worked example of these types of calculations.

Look at the videos below by Catalyst University (2018) and Chegg (2018), for other worked examples on interference and coefficient of coincidence.

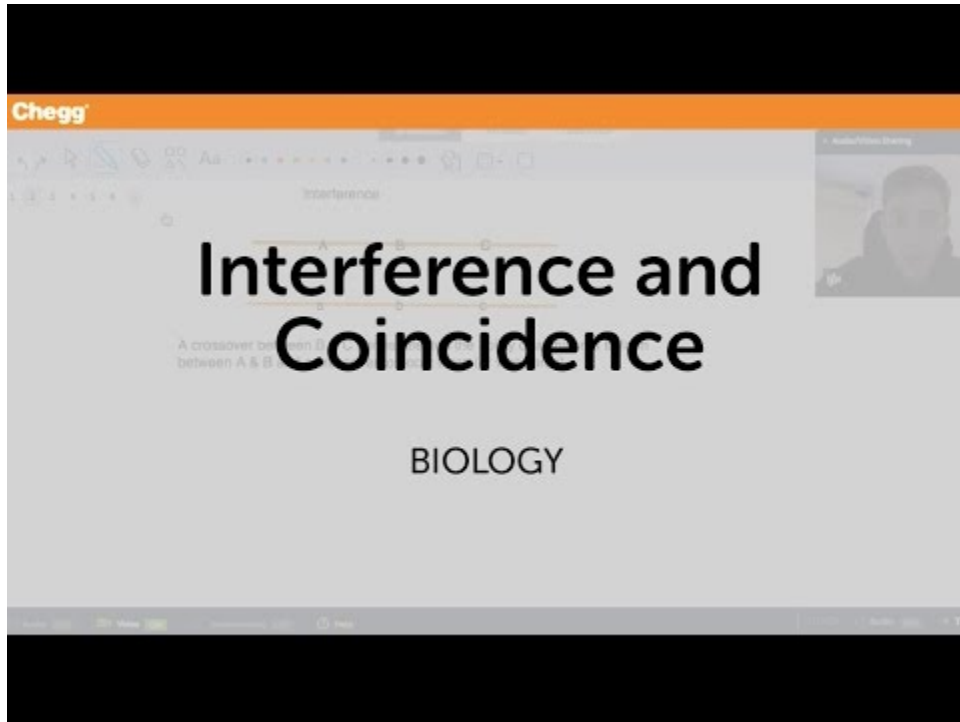

A YouTube element has been excluded from this version of the text. You can view it online here:

<https://opengenetics.pressbooks.tru.ca/?p=1079>

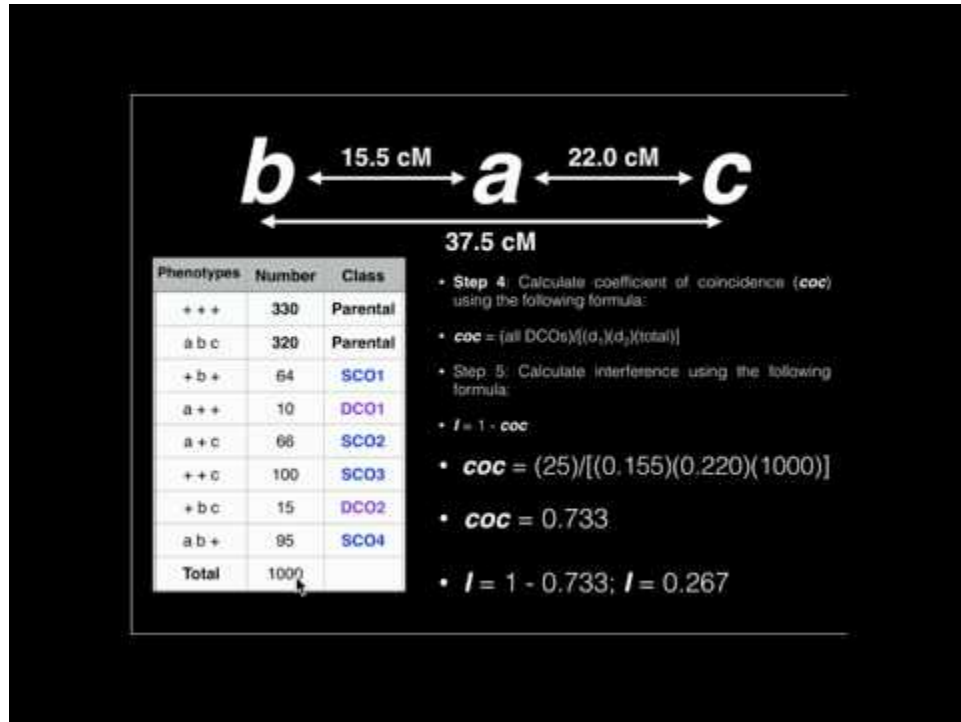

A YouTube element has been excluded from this version of the text. You can view it online here:

<https://opengenetics.pressbooks.tru.ca/?p=1079>

References

Catalyst University. (2018, March 29). Genetics: Linkage problem #1: Map distance, coefficient of coincidence, and interference (video file). YouTube. <https://www.youtube.com/watch?v=l7iOQDZsY7c>

Chegg. (2016, March 21). Interference and coincidence | Biology | Chegg Tutors (video file). YouTube. <https://www.youtube.com/watch?v=sJXLg-YSVIY>

McClellan, P. (1998). Deriving linkage distance and gene order from three-point crosses. *Genetic Linkage*/North Dakota State University. <https://www.ndsu.edu/pubweb/~mcclellan/plsc431/linkage/linkage3.htm>

Chapter 11 Summary

The topics covered in this chapter can be summarized as follows:

- A genetic map (or recombination map) is a representation of the linear order of genes (or loci), and their relative distances determined by crossover frequency, along a chromosome.
- Recombination frequency is usually proportional to the distance between loci, so recombination frequencies can be used to create genetic maps.
- Recombination frequencies tend to underestimate map distances, especially over long distances, since double crossovers may be indistinguishable from non-recombinants.
- Three-point crosses can determine the order and map distance among three loci.
- In three-point crosses, a correction for the distance of the outside markers can be made to account for double crossovers between the two outer loci.
- Interference is used to describe the degree to which one crossover interferes with other crossovers in the region at the chromosome in question.

Key Terms in Chapter 11

Key Terms – Recombination Mapping of Gene Loci

- Alfred Sturtevant
- centimorgans (cM)
- coefficient of coincidence
- conserved syntenic
- double-crossover
- genetic map
- independent assortment
- interference
- linked
- map units (mu)
- map-based cloning
- non-syntenic
- parentals
- recombinants
- syntenic
- Thomas Hunt Morgan
- three-point cross
- unlinked

Chapter 11 Study Questions

- In corn (i.e., maize, a diploid species), imagine that alleles for resistance to a particular pathogen are recessive and are linked to a locus that affects tassel length (short tassels are recessive to long tassels). Design a series of crosses to determine the map distance between these two loci. You can start with any genotypes you want, but be sure to specify the phenotypes of individuals at each stage of the process and specify which progeny will be considered recombinant. You do not need to calculate recombination frequency.
- In a mutant screen in *Drosophila*, you identified a gene related to memory, as evidenced by the inability of recessive homozygotes to learn to associate a particular scent with the availability of food. Given another line of flies with an autosomal mutation that produces orange eyes, design a series of crosses to determine the map distance between these two loci and specify which progeny will be considered recombinant. You do not need to calculate recombination frequency.
- Imagine that methionine heterotrophy, chlorosis (loss of chlorophyll), and absence of leaf hairs (trichomes) are each caused by recessive mutations at three different loci in *Arabidopsis*. Given a triple mutant, and assuming the loci are on the same chromosome, explain how you would determine the order of the loci relative to each other.
- Three loci are linked in the order B-C-A. If the A-B map distance is 1 cM, and the B-C map distance is 0.6 cM, given the lines *AaBbCc* and *aabbcc*, what will be the frequency of *Aabb* genotypes among their progeny if one of the parents of the dihybrid had the genotypes *AABBCC*?
- Genes for body colour (B black dominant to b yellow) and wing shape (C straight dominant to c curved) are located on the same chromosome in flies. If single mutants for each of these traits are crossed (i.e., a yellow fly crossed to a curved-wing fly), and their progeny is test crossed, the following phenotypic ratios are observed among their progeny.

Body Colour and Wing Shape	Phenotypic Ratios
black, straight	17
yellow, curved	12
black, curved	337
yellow, straight	364

- Calculate the map distance between B and C.
 - Why are the frequencies of the two smallest classes not exactly the same?
- Given the map distance you calculated between B-C in question 5, if you crossed a double mutant (i.e., yellow body and curved wing) with a wild-type fly, and test crossed the progeny, what phenotypes in what proportions would you expect to observe among the F₂ generation?
 - Wild-type mice have brown fur and short tails. Loss of function of a particular gene produces white fur, while loss of function of another gene produces long tails, and loss of function at a third locus produces agitated behaviour. Each of these loss of function alleles is recessive. If a wild-type mouse is crossed with a triple mutant, and their F₁ progeny is test-crossed, the following recombination frequencies are observed among their progeny. Produce a genetic map for these loci.

Fur	Tail	Behaviour	Frequency
white	short	normal	16
brown	short	agitated	0
brown	short	normal	955
white	short	agitated	36
white	long	normal	0
brown	long	agitated	14
brown	long	normal	46
white	long	agitated	933

Chapter 11 Answers

- Let *tt* be the genotype of a short tassels, and *rr* is the genotype of pathogen resistant plants. We need to start with homozygous lines with contrasting combinations of alleles, for example:
 P: *RRtt* (pathogen sensitive, short tassels) × *rrTT* (pathogen resistant, long tassels)
 F1: *RrTt* (sensitive, long) × *rrtt* (resistant, short)
 F2: parental *Rrtt* (sensitive, short), *rrTt* (resistant, long) recombinant *rrtt* (resistant, short), *RrTt* (sensitive, long)
- Let *mm* be the genotype of a mutants that fail to learn, and *ee* is the genotype of orange eyes. We need to start with homozygous lines with contrasting combinations of alleles, for example (wt means wild-type):
 P: *MMEE* (wt eyes, wt learning) × *mmee* (orange eyes, failure to learn)
 F1: *MmEe* (wt eyes, wt learning) × *mmee* (orange eyes, failure to learn)
 F2: parental *MmEe* (wt eyes, wt learning), *mmee* (orange eyes, failure to learn) recombinant *Mmee* (wt eyes, failure to learn), *mmEe* (orange eyes, wt learning)
- Given a triple mutant *aabbcc*, cross this to a homozygote with contrasting genotypes, i.e., *AABBCC*, then test cross the trihybrid progeny, i.e.:
 P: *AABBCC* × *aabbcc*
 F1: *AaBbCc* × *aabbcc*
 Then, in the F2 progeny, find the two rarest phenotypic classes; these should have reciprocal genotypes, e.g., *aaBbCc* and *AAbbcc*. Find out which of the three possible orders of loci (i.e., A-B-C, B-A-C, or B-C-A) would, following a double crossover that flanked the middle marker, produce gametes that correspond to the two rarest phenotypic classes. For example, if the rarest phenotypic classes were produced by genotypes *aaBbCc* and *AAbbcc*, then the dihybrid's contribution to these genotypes was *aBC* and *Abc*. Since the parental gametes were *ABC* and *abc*, the only gene order that is consistent with *aBC* and *Abc* being produced by a double crossover flanking a middle marker is B-A-C (which is equivalent to C-A-B).
- Based on the information given, the recombinant genotypes with respect to these loci will be *Aabb* and *aaBb*. The frequency of recombination between A-B is 1cM=1%, based on the information given in the question, so each of the two recombinant genotypes should be present at a frequency of about 0.5%. Thus, the answer is 0.5%.
- 4cM
 - Random sampling effects; the same reason that many human families do not have an equal number of boys and girls.
- There would be approximately 2% of each of the recombinants: (yellow, straight) and (black, curved), and approximately 48% of each of the parentals: (yellow, curved) and (black, straight).
- A is fur colour locus B is tail length locus C is behaviour locus

fur (A)	tail (B)	behaviour (C)	Frequency		AB	AC	BC
white	short	normal	16	<i>aBC</i>	R	R	P
brown	short	agitated	0	<i>ABc</i>	P	R	R
brown	short	normal	955	<i>ABC</i>	P	P	P
white	short	agitated	36	<i>aBc</i>	R	P	R
white	long	normal	0	<i>abC</i>	P	R	R
brown	long	agitated	14	<i>Abc</i>	R	R	P
brown	long	normal	46	<i>AbC</i>	R	P	R
white	long	agitated	933	<i>abc</i>	P	P	P

B C A

|-----|-----|

4.1cM 1.5cM

Pairwise recombination frequencies are as follows (calculations are shown below):

A - B 5.6% A - C 1.5% B - C 4.1%

AB	AC	BC
16	16	0
0	0	0
0	0	0
36	0	36
0	0	0
14	14	0
46	0	46
0	0	0
112	30	82
5.6%	1.5%	4.1%

CHAPTER 12 - PHYSICAL MAPPING OF CHROMOSOMES AND GENOMES

12.1 Introduction

Learning Objectives

- Distinguish among genetic (recombination), cytogenetic (metaphase chromosome), and physical maps.
- Differentiate chromosomes cytologically based on their length, centromere position, and banding patterns when stained with dyes.
- Discuss the ultimate physical map which is the DNA sequence of the whole chromosome or genome.

In this chapter, we will look at the larger picture of chromosomes and whole genomes, and the various methods used to visualize them. Many types of mapping techniques are available to identify single genes responsible for disorders, such as ankylosing spondylitis and cystic fibrosis, as well as the multiple genes responsible for common conditions, such as cardiovascular disease and diabetes mellitus. Gene and chromosome mapping are tools used to develop detection, monitoring, diagnosis and treatment regimens for persons suffering from genetic diseases. The advances in healthcare owe much of their success to the ability of geneticists to view genomes of organisms and analyze chromosomes at a level that allows insight into the transmission and manifestation of genetic diseases.

Before we go further, let us review some basics about chromosomes and genes. A functional chromosome requires four features, as shown in **Figure 12.1.1**.

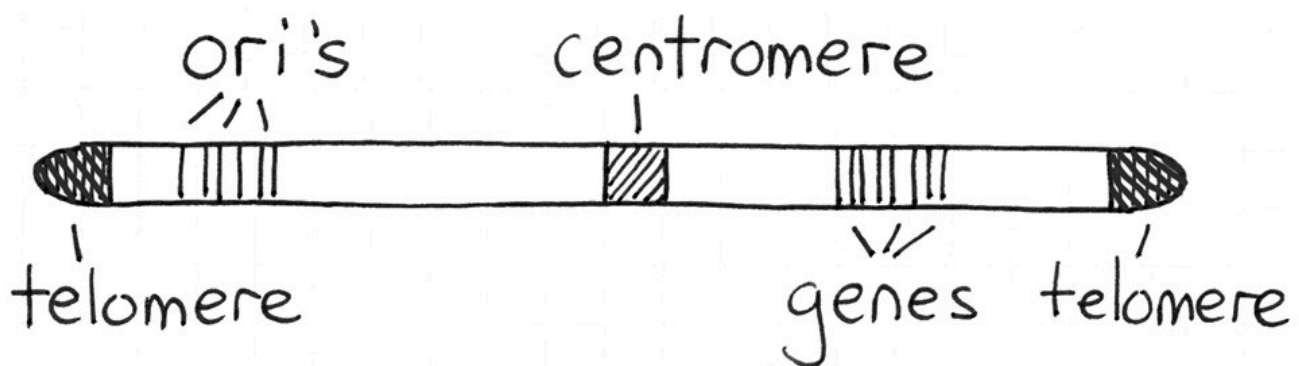

Figure 12.1.1 Parts of a Typical Human Nuclear Chromosome (Not to Scale). The *ori*'s and genes are distributed everywhere along the chromosome, except for the telomeres and centromere. [[Long description](#)]

Each chromosome is a long molecule of double-stranded DNA. They carry **genetic information** (genes). Chromosome 1, our largest chromosome, has the most genes – about 4778 in total. Many of these genes are transcribed into mRNAs, which encode proteins. Other genes are transcribed into tRNAs, rRNA, and other non-coding RNA molecules.

Media Attributions

- **Figure 12.1.1** [Original](#) by M. Harrington (2017), [CC BY-NC 3.0](#), Open Genetics Lectures
- **Figure 12.1.2** [NHGRI Fact Sheet- Genetic Mapping \(27058469495\)](#) by National Human Genome Research Institute (NHGRI) Image Gallery, [CC BY 2.0](#), via Wikimedia Commons

Reference

Harrington, M. (2017). Figure 6. Parts of a typical human nuclear chromosome ...[digital image]. In Locke, J., Harrington, M., Canham, L. and Min Ku Kang (Eds.), *Open Genetics Lectures, Fall 2017* (Chapter 15, p. 4). Dataverse/ BCcampus. http://solr.bccampus.ca:8001/bcc/file/7a7b00f9-fb56-4c49-81a9-cfa3ad80e6d8/1/OpenGeneticsLectures_Fall2017.pdf

Long Descriptions

- **Figure 12.1.1** Parts of a typical human nuclear chromosome are shown. The origins of replication and genes are distributed everywhere along the chromosome, except for the telomeres and centromere. Telomeres occur at the ends, and the centromere is shown near the middle of this chromosome. [Back to [Figure 12.1.1](#)]
- **Figure 12.1.2** A comparison of genetic maps, which show map distances in centimorgans, to cytogenetic maps, which show bands against contrasting colour which represent genes along the chromosome, to physical maps, which show map distances in megabase pairs, to finally the actual DNA sequence of the chromosome itself. Genetic mapping offers firm evidence that a disease transmitted from parent to child is linked to one or more genes. Mapping provides clues about which chromosome contains the gene, and precisely where the gene lies on that chromosome. Genetic maps have been used successfully to find the gene responsible for relatively rare, single-gene inherited disorders, such as cystic fibrosis and Duchenne muscular dystrophy. [Back to [Figure 12.1.2](#)]

12.2 Genetic Maps

We have already explored units of genetic distance (**map units/centiMorgans, cM**) and how this relates to recombination frequency. We can use this information in order to produce a **genetic map**; a “map” that shows the locations of genes along a linear chromosome. Note that map distances are always calculated for one pair of loci at a time. However, by combining the results of multiple pair-wise calculations, a genetic map of many loci on a chromosome can be produced (**Figures 12.2.1 & 12.2.2**). A genetic map shows the map distance, in cM, that separates any two loci, and the position of these loci relative to all other mapped loci. The genetic map distance is roughly proportional to the physical distance, i.e., the amount of DNA between two loci. For example, in *Arabidopsis*, 1.0 cM corresponds to approximately 150,000 bp and contains approximately 50 genes. The exact number of DNA bases in a cM depends on the organism, and on the particular position in the chromosome. Some parts of chromosomes (“crossover hot spots”) have higher rates of recombination than others, while other regions have reduced crossing over and often correspond to large regions of heterochromatin.

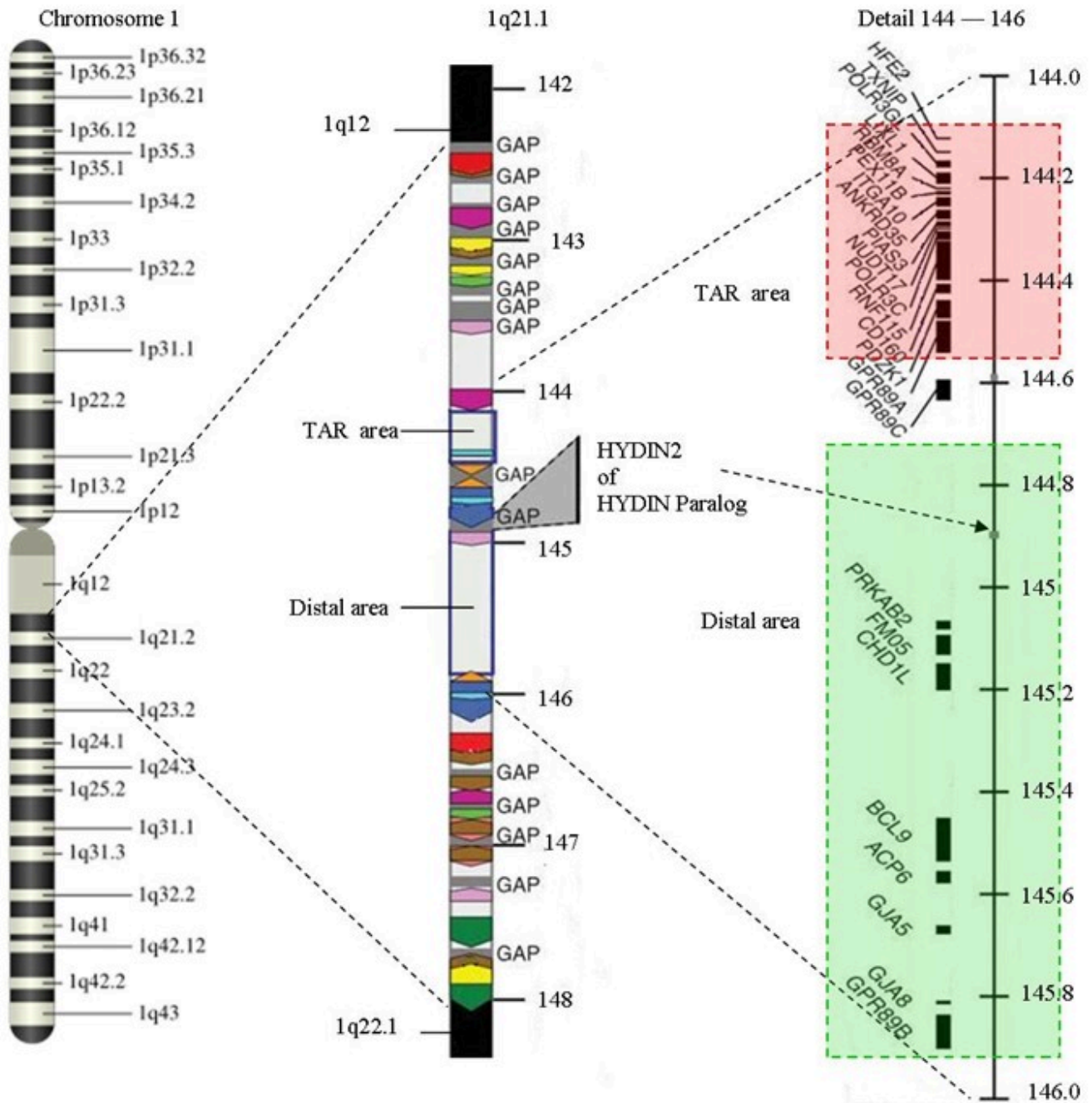

Figure 12.2.1 Genetic Map of Human Chromosome 1, Shown with a Region Expanded to Show the Genes Within [Long description]

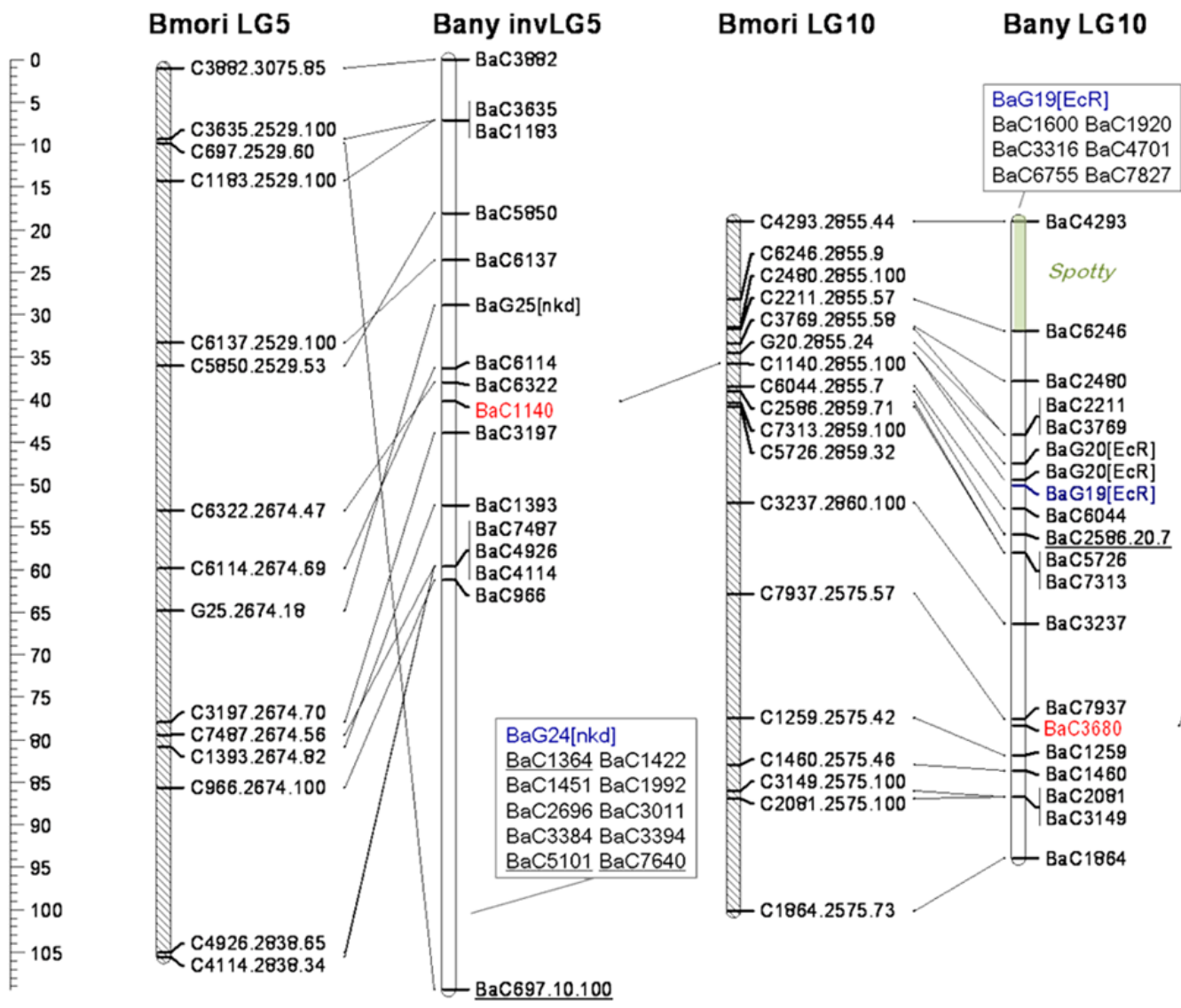
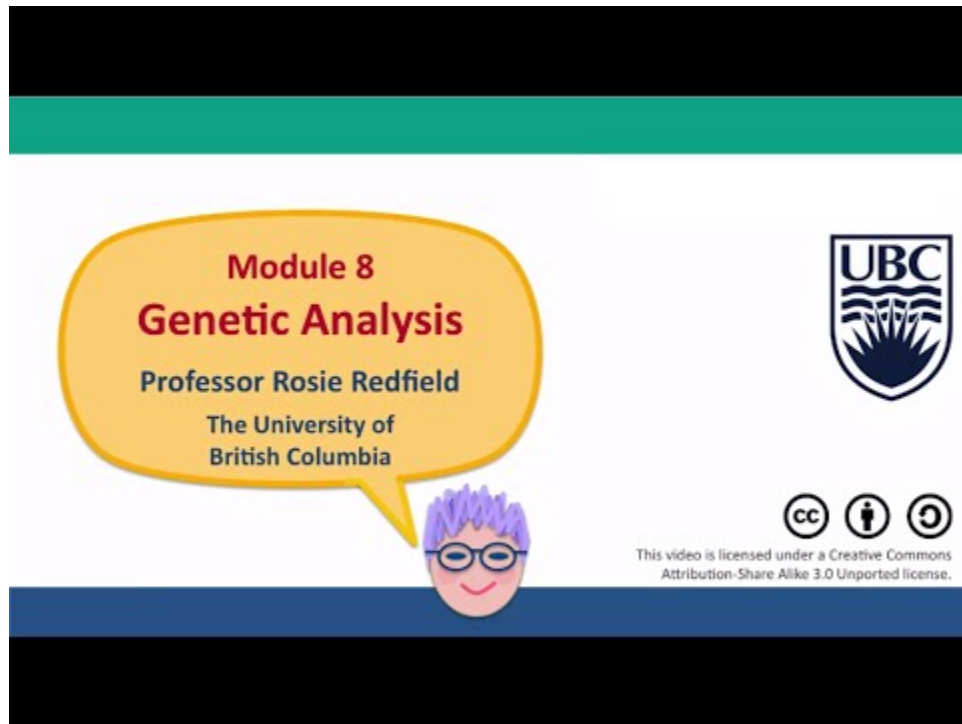

Figure 12.2.2 Genetic Maps for Regions of Two Chromosomes from Two Species of the Silk Moth, *Bombyx*. The scale at left shows distance in cM, and the position of various loci is indicated on each chromosome. Diagonal lines connecting loci on different chromosomes show the position of corresponding loci in different species. This is referred to as regions of conserved synteny. [Long description]

When a novel gene or locus is identified by mutation or polymorphism, its approximate position on a chromosome can be determined by crossing it with previously mapped genes, and then calculating the **recombination frequency**. If the novel gene and the previously mapped genes show complete or partial linkage, the recombination frequency will indicate the approximate position of the novel gene within the genetic map. This information is useful in isolating (i.e., cloning) the specific fragment of DNA that encodes the novel gene, through a process called **map-based cloning**. Genetic maps are also useful to track genes/alleles in breeding crops and animals, in studying evolutionary relationships between species, and in determining the causes and individual susceptibility of some human diseases.

Watch the video below, 8H – *Physical and Genetic Linkage and Maps*, presented by Professor Redfield (Useful Genetics, 2015) of UBC, which discusses genetic mapping.



A YouTube element has been excluded from this version of the text. You can view it online here:

<https://opengenetics.pressbooks.tru.ca/?p=1118>

Examples of Genes in Humans

LCT – An Autosomal Gene

The *LCT* gene encodes the enzyme Lactase. This enzyme allows people to digest the milk sugar lactose. The *LCT* gene is on chromosome 2. Because this is an autosome, everyone has a maternal and a paternal copy of the *LCT* gene. Genes come in different versions called alleles. The allele of the *LCT* gene you inherited from your mother will probably be slightly different from the allele you received from your father. Thus, most people have two different alleles of this gene. If we consider a cell in G1 there will be two pieces of DNA inside the nucleus that harbour this gene. When this cell completes DNA replication there will be four copies of this gene. But because the chromatids on your maternal chromosome 2 are identical, as are the chromatids on your paternal chromosome 2, this cell will still have just two different alleles. Because of this, we simplify things by saying that humans have two copies of *LCT*. Since most genes are on autosomes, you have two copies of most of your genes.

F8 – An x Chromosomal Gene

The *F8* gene makes a blood-clotting protein called Coagulation Factor VIII (*F8*). Without normal *F8* a person is unable

to stop bleeding if injured. The F8 gene is located on the X chromosome. Females, with two X chromosomes, have two copies of the F8 gene. Males only have one X chromosome and thus a single F8 gene. This has an impact on male health, a topic discussed in [Chapter 4](#) on pedigree analysis.

SRY – A y Chromosomal Gene

The SRY gene is only found in males, because it is located on the Y chromosome (See [Chapter 10](#)). Males have this gene and females do not. In embryogenesis, the presence this gene leads to being male. Its absence leads to being female. A pair of organs called the gonads can develop into either ovaries or testes. In XY embryos the SRY gene makes a protein that causes the gonads to develop into testes. Conversely, XX embryos do not have this gene and their gonads develop into ovaries instead. Once formed the testes produce sex hormones that direct the rest of the developing embryo to become male, while the ovaries make different sex hormones that promote female development. The testes and ovaries are also the organs where gametes (sperm or eggs) are produced. Whether a person is genetically male or female is decided at the moment of conception, if the sperm carries a Y chromosome the result is a male and if the sperm carries an X the result is a female.

MT-CO1 – A Mitochondrial Gene

The MT-CO1 gene is located on the mtDNA chromosome. It encodes a protein in Complex IV of the mitochondrial electron transport chain. For reasons that are not clear, this protein must be made in the mitochondria. It cannot be synthesized in the cytosol of the cell and then imported into the mitochondria, as is the case, with most mitochondrial proteins. Because humans generally receive their mitochondria from their mother, everyone has only one MT-CO1 gene. It is the same one found in their mother (and her mother). Technically speaking we have only one MT-CO1 *allele*, it will be identical on all of the mtDNA molecules, in all of the mitochondria, in all of the cells.

In summary:

Table 12.2.1 The Number of Alleles for Genes in Males and Females

Location of a gene	Number of alleles of this gene in males	Number of alleles of this gene in females
Autosomal chromosome	2	2
X chromosome	1	2
Y chromosome	1	0
Mitochondrial chromosome	1	1

Media Attributions

- **Figure 12.2.1** [Chromosome 1 to 1q21.1](#) by SpelgroepPhoenix, [CC BY-SA 3.0](#), via Wikimedia Commons
- **Figure 12.2.2** [Figure 3](#) attributed to [NCBI-NIH](#) (2017), public domain, Open Genetics Lectures, modified from [original](#) from Beldade et al (2009).

References

- Beldade, P., Saenko, S. V., Pul, N., Long, A. D. (2009, February). Figure 3. A gene-based linkage map for *bicyclus anynana* butterflies allows for a comprehensive analysis of synteny with the lepidopteran reference genome [digital image]. *PLOS Genetics* 5(2): e1000366. <https://doi.org/10.1371/journal.pgen.1000366.g003>
- NCBI-NIH. (2017). Figure 3. Genetic maps for regions of two chromosomes...[digital image]. In Locke, J., Harrington, M., Canham, L. and Min Ku Kang (Eds.), *Open Genetics Lectures, Fall 2017* (Chapter 19, p. 2). Dataverse/BCcampus. http://solr.bccampus.ca:8001/bcc/file/7a7b00f9-fb56-4c49-81a9-cfa3ad80e6d8/1/OpenGeneticsLectures_Fall2017.pdf
- Redfield, R./ UBC [Useful Genetics]. (2015, August 23). 8H – Physical and genetic linkage and maps (video file). YouTube. https://www.youtube.com/watch?v=ssbKpbv6t_w

Media Attributions

- **Figure 12.2.1** Genetic map of the human chromosome 1, showing in the first instance, a cytogenetic map, with various regions identified based on their position on the chromosome (p arm or q arm), then, one of these regions is expanded to show the numerous areas which lie within this region, and then, an even smaller sub-region is expanded to show the details of the genes within. [Back to [Figure 12.2.1](#)]
- **Figure 12.2.2** Genetic Maps for Regions of Two Chromosomes from Two Species of the Silk Moth, *Bombyx*. The scale at left shows distance in cM, and the position of various loci is indicated on each chromosome. Diagonal lines connecting loci on different chromosomes show the position of corresponding loci in different species. This is referred to as regions of conserved synteny. [Back to [Figure 12.2.2](#)]

12.3 Cytogenetic Maps

Cytogenetics is sometimes referred to as a branch of genetics which deals with how chromosomes relate to cell behaviour, particularly during mitosis and meiosis. A cytogenetic map is produced after staining metaphase chromosomes with a particular dye mixture and visualizing the dark and light-coloured bands under microscope. Each chromosome pair stains with its own characteristic banding pattern. The bands correlate approximately with the DNA sequence underlying it: AT-rich areas stain darkly, GC-rich areas lightly. To cytologically describe a chromosome is to describe its length, centromere position, and banding pattern after staining. **Cytogeneticists** can observe chromosomes at any stage of the cell cycle but those from metaphase cells provide the most detail and clarity. **Figure 12.3.1** shows a more magnified view of a pair of chromosomes. On average, a condensed human metaphase chromosome is 5 μm long and each chromatid is 700 nm wide. In contrast, a decondensed interphase chromosome is 2 mm long and only 30 nm wide, yet still fits into a single nucleus.



Figure 12.3.1 A Pair of Metacentric Human Chromosome #1 [[Long description](#)]

Karyograms

Human cytogeneticists use metaphase chromosome spreads as a standard representation of the chromosomes in a cell, organism, or species. Comparisons permit them to identify chromosome abnormalities. Because it can be hard to distinguish individual chromosomes, cytogeneticists sort the photo to put the chromosomes into a standard pattern. The result is a **karyogram** (“nucleus picture”; **Figure 12.3.2**). In the past, it was necessary to print a photograph of the metaphase spread, cut out each chromosome with scissors, and then glue each to a piece of cardboard to show the pattern. Now, computer software does much of this for us, but the karyogram assembly is usually reviewed by a qualified cytogeneticist. Each eukaryotic species has its nuclear genome divided among a number of chromosomes that is characteristic of that species. For example, a haploid human nucleus (i.e., sperm or egg) normally has 23 chromosomes ($n=23$), and a diploid human nucleus has 23 pairs of chromosomes ($2n=46$). A **karyotype** is the complete set of chromosomes of an individual. In **Figure 12.3.2**, the cell was in metaphase so each of the 46 structures is a replicated chromosome even though it is hard to see the two sister chromatids for each chromosome at this resolution. As expected, there are 46 chromosomes. Note that the chromosomes have different lengths. In fact, human

chromosomes were named based upon this feature. Our largest chromosome is called 1, our next longest is 2, and so on.

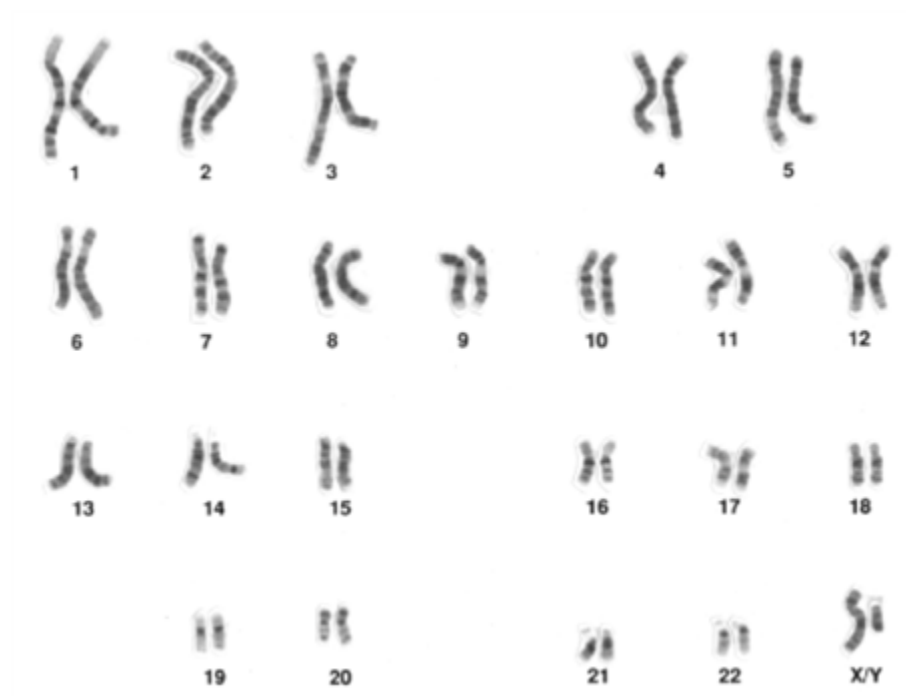
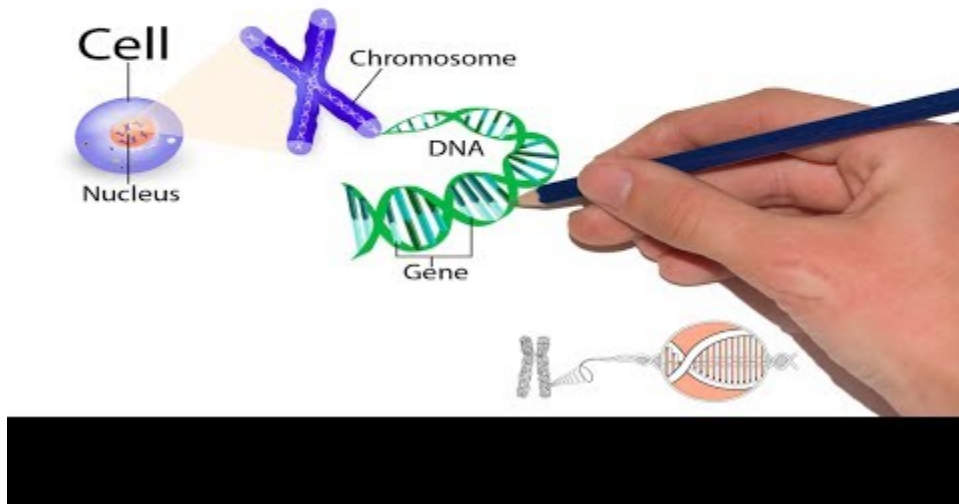

Figure 12.3.2 Karyogram of a Normal Human Male [[Long description](#)]

Take a look at the video below, *Gene Mapping/ How to Decode 13q14.3*, by Medinaz (2017) on YouTube, which discusses cytogenetic mapping.

GENE MAPPING



A YouTube element has been excluded from this version of the text. You can view it online here:

<https://opengenetics.pressbooks.tru.ca/?p=1124>

The chromosomes are numbered to distinguish them. Chromosomes 1 through 22 are **autosomes**, which are present in two copies in both males and females. Because human chromosomes vary in size, this was the easiest way to label them. Our largest chromosome is number 1, our next longest is 2, and so on. The karyogram above shows two copies of each of the autosomes. A karyogram from a normal female would also show these 22 pairs. There are also the sex-chromosomes, X and Y. Normal females have two X-chromosomes, while normal males have an X and a Y each. They act as a homologous pair, similar to the autosomes. During meiosis, only one of each autosome pair and one of the sex-chromosomes makes it into the gamete. This is how $2n = 46$ adults can produce $1n = 23$ eggs or sperm. In addition to their length, Cytogeneticists can distinguish chromosomes using their centromere position and banding pattern. Note that at the resolution in **Figure 12.3.2**, both chromosome 1's look identical, even though at the base pair level there are small, and often significant, differences in the sequence that correspond to allelic differences between these homologous chromosomes. Remember that in each karyogram there are **maternal chromosomes**, those inherited from their mother, and **paternal chromosomes**, those from their father. For example, everyone has one maternal chromosome 1 and one paternal chromosome 1. In a typical karyogram, it is usually not possible to tell which is which. In some cases, however, there are visible differences between homologous chromosomes that do permit the distinction to be made.

A chromosome has a telomere and centromere, which are usually in a heterochromatin state. Centromere is DNA sequences that are bound by centromeric proteins that link the centromere to microtubules. Centromere can be in the middle (**metacentric**), near to the middle (**submetacentric**), near the end (**acrocentric**), at the end (**telocentric**) or the entire chromosome can act as a chromosome (**holocentric**). Telomeres are repetitive sequences like TTAGGG at the end

of the chromosomes that help maintain the length of the chromosome. Another feature is that, in a chromosome, there are **p arm** (petite = small) and **q arm** (queue = tail or just the next letter in the alphabet).





Centromere Location	Name	Shape
middle	metacentric	
around middle	submetacentric	
towards one end	acrocentric	
at one end	telocentric	

Figure 12.3.3 Table Showing Four Types of Centromere Location [[Long description](#)]

Various stains and fluorescent dyes like Trypsin+Giesma and Quinacrine are used to produce characteristic banding patterns to distinguish all 23 chromosomes. These bands are first grouped in regions, sectioned into bands, and further divided into sub-bands. Notice that the band numbers start from the centromere and extend towards the tip of each arm (**Figure 12.3.4**). The number of chromosomes varies between species, but there appears to be very little correlation between chromosome number and either the complexity of an organism or its total amount of genomic DNA.

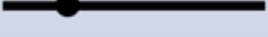
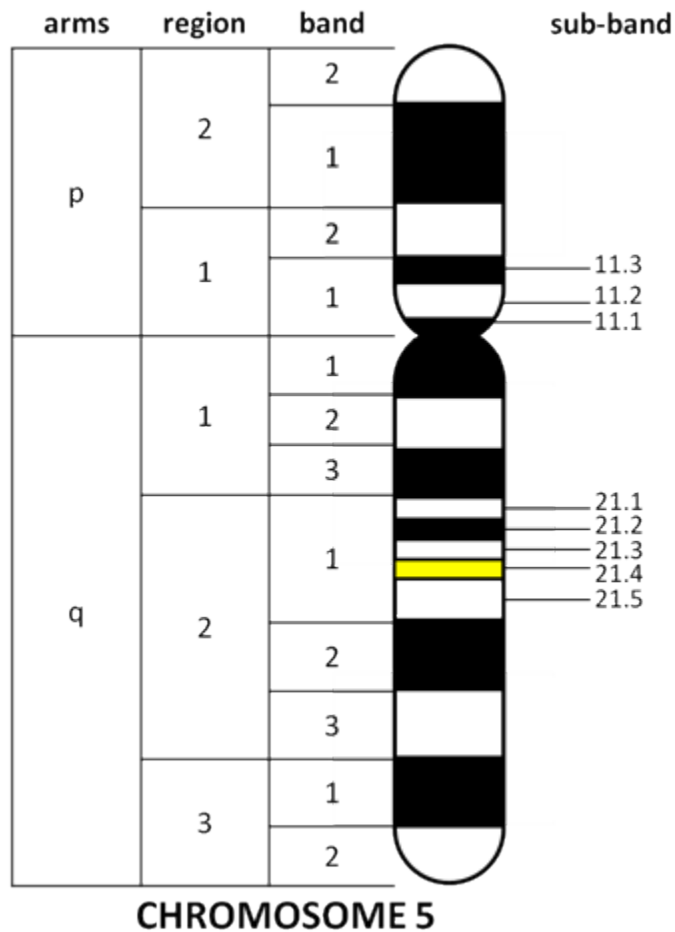
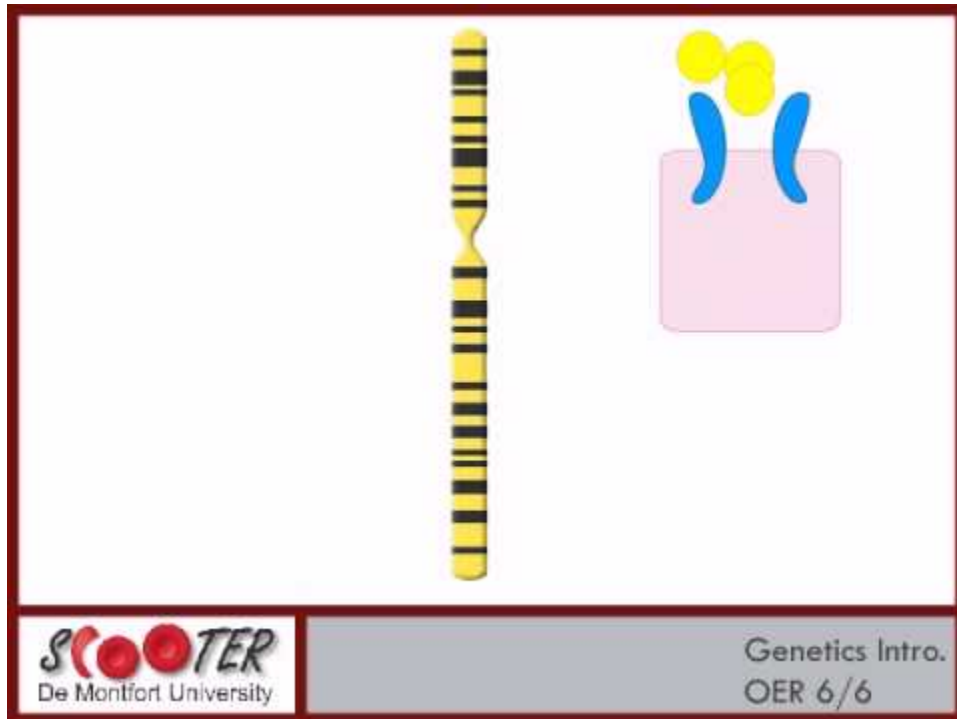

Figure 12.3.4 Fictional Diagram of a Human Chromosome and its Bands. A chromosome has *p* and *q* arm, which are both divided by regions. These regions are divided by bands, and these bands are subdivided into sub-bands. The bands are numbered away from the centromere, and sub-bands are renumbered for each bands. Notice that this fictional diagram was made for educational purposes. [[Long description](#)]

Here is another video on cytogenetic mapping by SCOOTERDMU (2011) on YouTube, *Genetics – Cytogenetic Maps Part 6 of 6*.



A YouTube element has been excluded from this version of the text. You can view it online here:

<https://opengenetics.pressbooks.tru.ca/?p=1124>

Media Attributions

- **Figure 12.3.1** [Human male karyotype high resolution – Chromosome 1 cropped](#) by National Human Genome Research Institute/ [Talking Glossary of Genetics, public domain](#), via Wikipedia
- **Figure 12.3.2** [Human male karyotype high resolution](#) by National Human Genome Research Institute/ [Talking Glossary of Genetics, public domain](#), via Wikipedia
- **Figure 12.3.3** [Original](#) (table) by Harrington/Kang (2017), [CC BY-NC 3.0](#), Open Genetics Lectures
- **Figure 12.3.4** [Original](#) by Kang (2017), [CC BY-NC 3.0](#), Open Genetics Lectures

References

Harrington, M., Kang, M. K. (2017). Table 1. Table showing four types of centromere location [digital image]. In Locke, J., Harrington, M., Canham, L. and Min Ku Kang (Eds.), *Open Genetics Lectures, Fall 2017* (Chapter 27, p. 2). Dataverse/ BCCampus. http://solr.bccampus.ca:8001/bcc/file/7a7b00f9-fb56-4c49-81a9-cfa3ad80e6d8/1/OpenGeneticsLectures_Fall2017.pdf

Kang, M. K. (2017). Figure 4. Fictional diagram of a human chromosome and its bands ...[digital image]. In Locke, J., Harrington, M., Canham, L. and Min Ku Kang (Eds.), *Open Genetics Lectures, Fall 2017* (Chapter 27, p. 3). Dataverse/

BCcampus. http://solr.bccampus.ca:8001/bcc/file/7a7b00f9-fb56-4c49-81a9-cfa3ad80e6d8/1/OpenGeneticsLectures_Fall2017.pdf

Medinaz. (2017). Gene mapping/ How to decode 13q14.3 (video file). YouTube. <https://www.youtube.com/watch?v=gGUxf-aL1DA>

SCOOTERDMU (2011). Genetics – Cytogenetic maps Part 6 of 6. YouTube. <https://www.youtube.com/watch?v=DjJEYzAyjJY>

Long Descriptions

- **Figure 12.3.1** A pair of homologous chromosomes (human chromosome 1) which are metacentric. The pair stains with its own characteristic banding pattern. The bands correlate approximately with the DNA sequence underlying it: AT-rich areas stain darkly, GC-rich areas lightly. [Back to [Figure 12.3.1](#)]
- **Figure 12.3.2** A karyogram, which is a visualization of all the chromosomes in their condensed state of a cell in a particular organism. Twenty-three pairs of chromosomes are observed in a somatic cell of a human male – we see 22 pairs of autosomes and one pair of sex-chromosomes which are labelled XY. The Y chromosome is seen to be significantly smaller than the X chromosome. [Back to [Figure 12.3.2](#)]
- **Figure 12.3.3** Representation of the four main types of chromosomes in terms of centromere position: metacentric chromosomes have centromeres at the middle, submetacentric have centromeres slightly away but around the middle, acrocentric chromosomes have centromeres towards one end, and telocentric chromosomes have centromeres at one end. [Back to [Figure 12.3.3](#)]
- **Figure 12.3.4** Fictional diagram of a human chromosome and its bands. A chromosome has p and q arm, which are both divided by regions. These regions are divided by bands, and these bands are subdivided into sub-bands. The bands are numbered away from the centromere, and sub-bands are renumbered for each bands. So the division goes arm, region, band and then sub-band. [Back to [Figure 12.3.4](#)]

12.4 Physical Maps

Human Genome Project (HGP)

In 2003, the HGP or Human Genome Project (which started in 1990) was completed. The HGP was an international collaborative endeavor, with the goal of determining the base pairs that comprise human DNA and sought to identify and map all the genes of the human genome from both a physical and a functional standpoint. The group of publicly funded researchers that eventually assembled was known as International Human Genome Sequencing Consortium (IHGSC). More than 18 different countries from across the globe had contributed to the Human Genome Project by the time of its completion. Determining the sequence of base pairs for each human chromosome allowed researchers to provide a more specific address than the cytogenetic location for many genes. A gene's molecular location identifies that gene in terms of base pairs. It describes the gene's precise position on a chromosome and indicates the size of the gene. Knowing the molecular location also allows researchers to determine exactly how far a gene is from other genes on the same chromosome. Different groups of researchers often determine slightly different values for a gene's molecular location. Researchers interpret the sequence of the human genome using a variety of methods, which may result in slight differences in a gene's molecular address.

Please visit [The National Human Genome Research Institute](http://www.genome.gov) to read more about the Human Genome Project.

The following TED Ed video, *How to Sequence the Human Genome*, presented by Mark J. Kiel (2013) on YouTube, discusses the Human genome and the Human Genome Project.

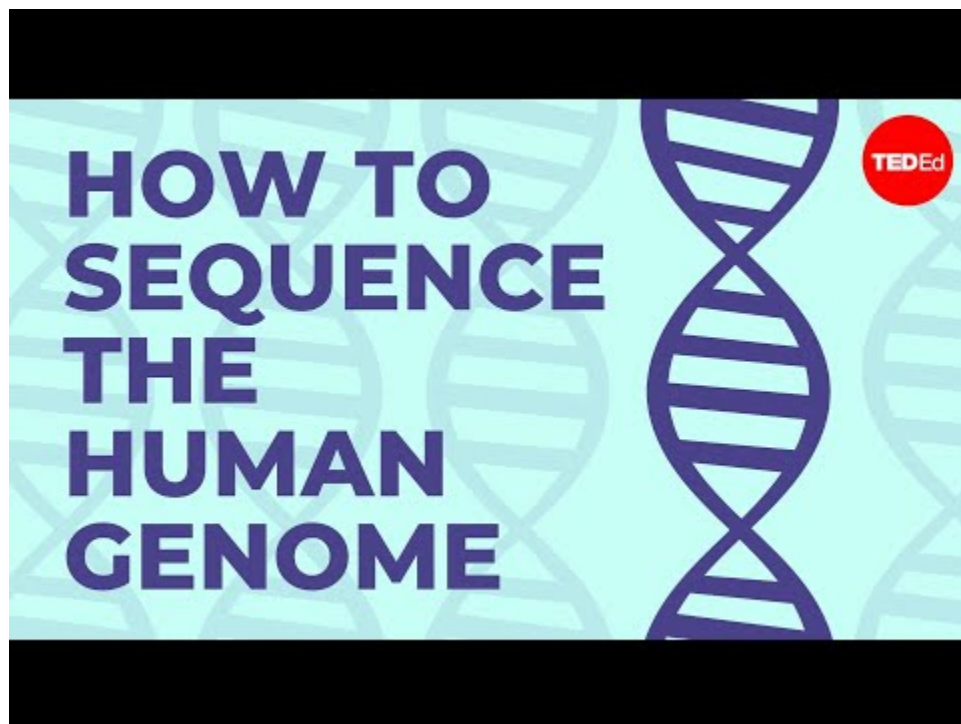

A YouTube element has been excluded from this version of the text. You can view it online here:
<https://opengenetics.pressbooks.tru.ca/?p=1187>

The ultimate physical map is an accurate representation of the DNA sequence of a genome. These days that sequence is usually held in a computer database and is accessible via the Internet. This wasn't always the case. The first genome sequences were constructed from a series of large, cloned physical fragments of DNA. The map was, therefore, made from physical entities (pieces of DNA) rather than abstract concepts such as the linkage frequencies between genes that make up a genetic map. It is usually possible to correlate genetic and physical maps, for example, by identifying the clone that contains a particular molecular marker. The connection between physical and genetic maps allows the genes underlying particular mutations to be identified through a process call **map-based cloning**.

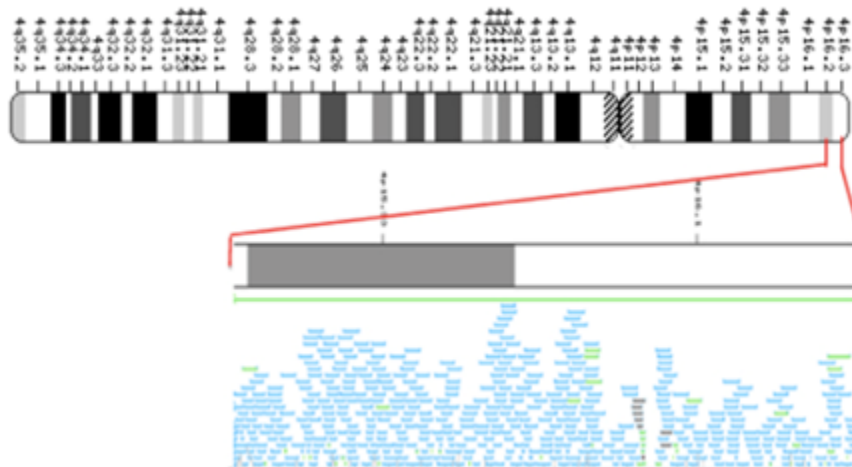

Figure 12.4.1 A Portion of the Physical Map for Human Chromosome 4. The entire chromosome is shown at left. The physical map is derived from the small blue lines, each of which represents a cloned piece of DNA approximately 100kb in length. [[Long description](#)]

To create a physical map, large fragments of the genome are cloned into plasmid vectors, or into larger vectors called bacterial artificial chromosomes (BACs). BACs can contain approximately 100kb fragments. Typically, the set of sequences in a BAC clone library will contain redundant, overlapping sequences. Meaning that different clones will contain DNA from the same part of the genome so there are going to be some overlaps. Because of these overlaps, it is possible to select the minimum set of clones that represent the entire genome, and to order these clones respective to the sequence of the original chromosome. Note that this is all to be done without knowing the complete sequence of each BAC. A set of overlapping clones is called a **contig**. Making a contig map can rely on techniques related to Southern blotting: DNA from the ends of one BAC is used as a probe to find clones that contain the same sequence in another, overlapping BAC clone. These clones are then assumed to overlap each other. This process of finding overlaps can progress to position all the clones into overlapping series that span the genome. Also, if we already know the sequence of one strain of a simple organism, it can be used as a reference for mutant strains and can identify the differences in the sequences.

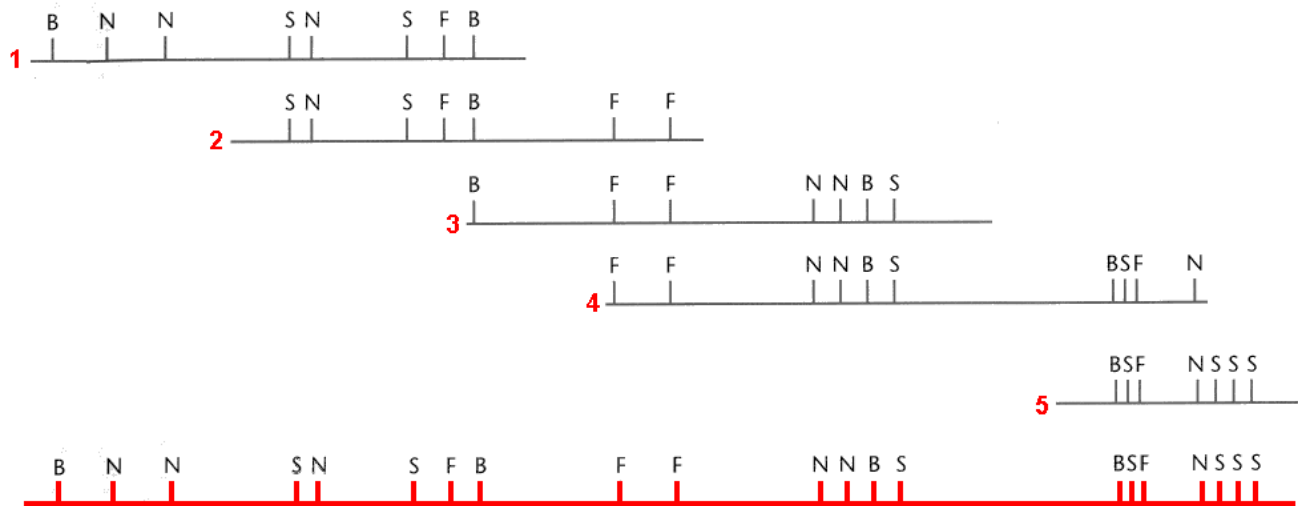

Figure 12.4.2 A Series of Overlapping Cloned Sequences Can be Combined to Eventually Span Much Larger Regions, Including Whole Chromosomes [\[Long description\]](#)

Small-sized, genome-like Lambda DNA is only 48kb long, but most chromosomes are Mb long. Currently, the only way to construct physical maps of large regions is through the joining of smaller regions to map a larger or whole portion of the chromosome. In order to do this, small, multiple copies of the chromosome have to be broken down into little pieces with different length and frames using restriction enzymes, so that they can partially overlap with each other. The continual overlaps of the fragments will eventually form a whole map of the chromosome. This contiguous assembly of clones is called contig.

Restriction Mapping Procedure

Restriction mapping is an inexpensive, quick, and easy method to describe a sample of cloned DNA. It is preferred over DNA sequencing for these reasons, but the sequence is still the ultimate description. Restriction mapping is the technique for identifying the location of restriction sites, relative to other sites on a DNA molecule. Typically, a sample of purified cloned DNA is aliquoted into several tubes and each is treated with several different restriction enzymes or combination of enzymes. These are then separated by agarose gel electrophoresis and the restriction fragment sizes determined by comparison to known size markers. By trial and error, the combination of fragments can be assembled like a linear jigsaw puzzle into a map of the restrictions sites – a **restriction map** (**Figure 12.4.3**). One can increase the resolution of the restriction site map by mapping more restriction sites.

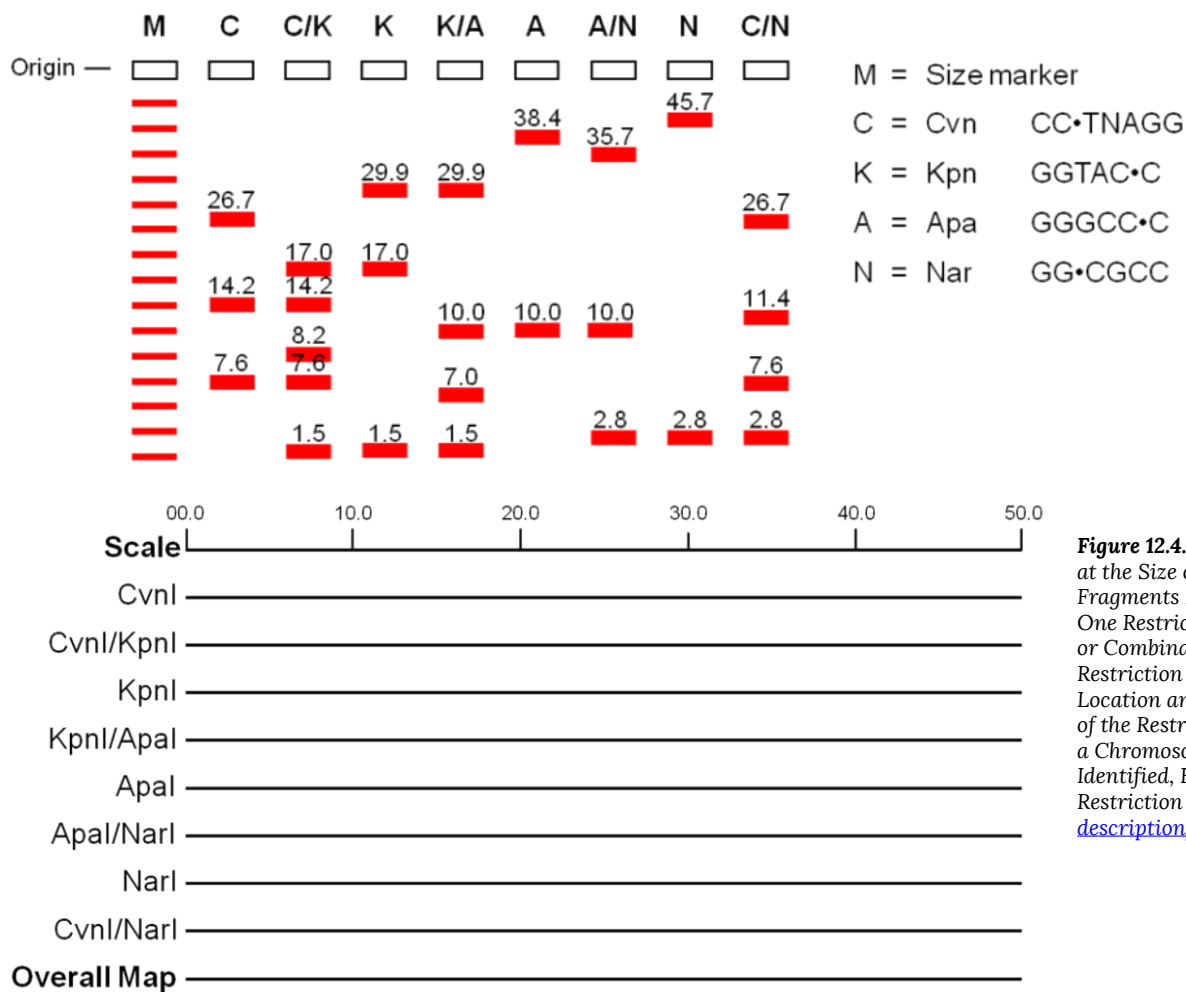

Figure 12.4.3 By Looking at the Size of the Fragments Produced by One Restriction Enzyme or Combination of the Restriction Enzymes, the Location and the Order of the Restriction Site on a Chromosome Can Be Identified, Forming a Restriction Map [[Long description](#)]

Restriction mapping is also a quick, easy, and inexpensive way to characterize and distinguish DNA samples without actually sequencing the DNA; sequences can be represented by series of restriction sites and using this knowledge, one can tell if the DNA of interest is similar or different from others by comparing their degree of overlaps. Also, restriction sites offer positions for convenient manipulation of the DNA. Restriction fragments that contain the gene of interest can be cut out and once the gene is purified from the fragments, it can be sequenced or used as a probe. This is the reason why restriction mapping is still routinely used today, even though sequencing technologies allows us to sequence the whole genome.

Media Attributions

- **Figure 12.4.1** [Original](#) attributed to NCBI-unknown (2017), public domain, Open Genetics Lectures
- **Figure 12.4.2** [Original](#) by J. Locke (2017), [CC BY-NC 3.0](#), Open Genetics Lectures
- **Figure 12.4.3** [Original](#) by J. Locke (2017), [CC BY-NC 3.0](#), Open Genetics Lectures

References

Locke, J. (2017). Figures: 6. A series of overlapping cloned sequences; and 7. By looking at the size of the fragments... [digital image]. In Locke, J., Harrington, M., Canham, L. and Min Ku Kang (Eds.), *Open Genetics Lectures, Fall 2017* (Chapter 27, p. 5). Dataverse/ BCcampus. http://solr.bccampus.ca:8001/bcc/file/7a7b00f9-fb56-4c49-81a9-cfa3ad80e6d8/1/OpenGeneticsLectures_Fall2017.pdf

National Human Genome Research Institute. (n.d.). The human genome project (accessed January 18, 2022; last updated: December 22, 2020). National Institute of Health (NIH)/ United States Government. <https://www.genome.gov/human-genome-project>

NCBI-unknown. (2017). Figure 5. A portion of the physical map for human chromosome [digital image]. In Locke, J., Harrington, M., Canham, L. and Min Ku Kang (Eds.), *Open Genetics Lectures, Fall 2017* (Chapter 27, p. 4). Dataverse/ BCcampus. http://solr.bccampus.ca:8001/bcc/file/7a7b00f9-fb56-4c49-81a9-cfa3ad80e6d8/1/OpenGeneticsLectures_Fall2017.pdf

TED-Ed. (2013, December 7). How to sequence the human genome – Mark J. Kiel (video file). YouTube. <https://www.youtube.com/watch?v=MvuYATH7Y74>

Long Descriptions

- **Figure 12.4.1** A portion of the physical map for human chromosome 4. The entire chromosome is shown as a cytogenetic map and the resulting physical map is derived from a small identified portion of the original chromosome. [Back to [Figure 12.4.1](#)]
- **Figure 12.4.2** A series of overlapping cloned sequences can be combined to eventually span much larger regions, including whole chromosomes, much like piecing together a puzzle, using individual pieces which overlap. [Back to [Figure 12.4.2](#)]
- **Figure 12.4.3** By looking at the size of the fragments produced by one restriction enzyme or a combination of the restriction enzymes, the location and the order of the restriction site on a chromosome can be identified, forming a restriction map. [Back to [Figure 12.4.3](#)]

Chapter 12 Summary

The topics covered in this chapter can be summarized as follows:

- There are different types of chromosome maps: genetic (recombination), cytogenetic (metaphase chromosome), and physical maps.
- Recombination frequency is usually proportional to the distance between loci, and so recombination frequencies can be used to create genetic maps.
- Chromosomes can be distinguished cytologically based on their length, centromere position, and banding patterns when stained with dyes.
- Single clones can be restriction mapped and then combined into a contig that represents a larger region of DNA, ultimately the whole chromosome.
- The ultimate physical map is the DNA sequence of the whole chromosome or genome.

Key Terms in Chapter 12

Key Terms – Physical Mapping of Chromosomes and Genomes

- centiMorgans
- contig construction
- contig
- genetic map
- karyogram
- karyotype
- map units
- map-based cloning
- physical map
- recombination frequency
- restriction map

Chapter 12 Study Questions

- Three loci are linked in the order B-C-A. If the A-B map distance is 1 cM, and the B-C map distance is 0.6 cM, given the lines *AaBbCc* and *aabbcc*, what will be the frequency of *Aabb* genotypes among their progeny if one of the parents of the dihybrid had the genotypes *AABBCC*?
- Given the restriction digests and with the fragment sizes shown in the gel diagram, can you construct a map of this linear DNA molecule (Lambda DNA)?

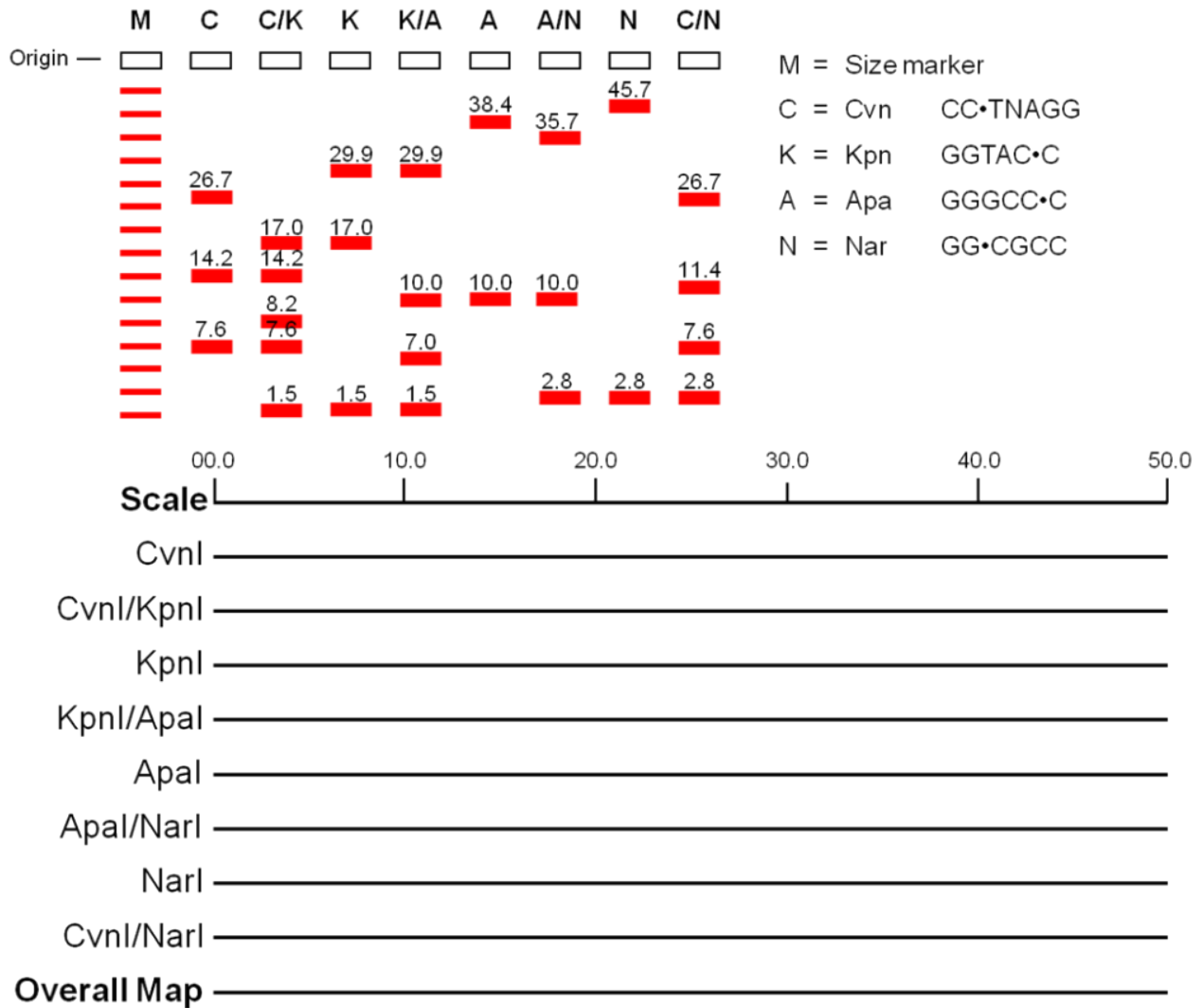

Chapter 12 Answers

- Based on the information given, the recombinant genotypes with respect to these loci will be *Aabb* and *aaBb*. The frequency of recombination between A-B is 1 cM=1%, based on the information given in the question, so each of the two recombinant genotypes should be present at a frequency of about 0.5%. Thus, the answer is 0.5%.
-

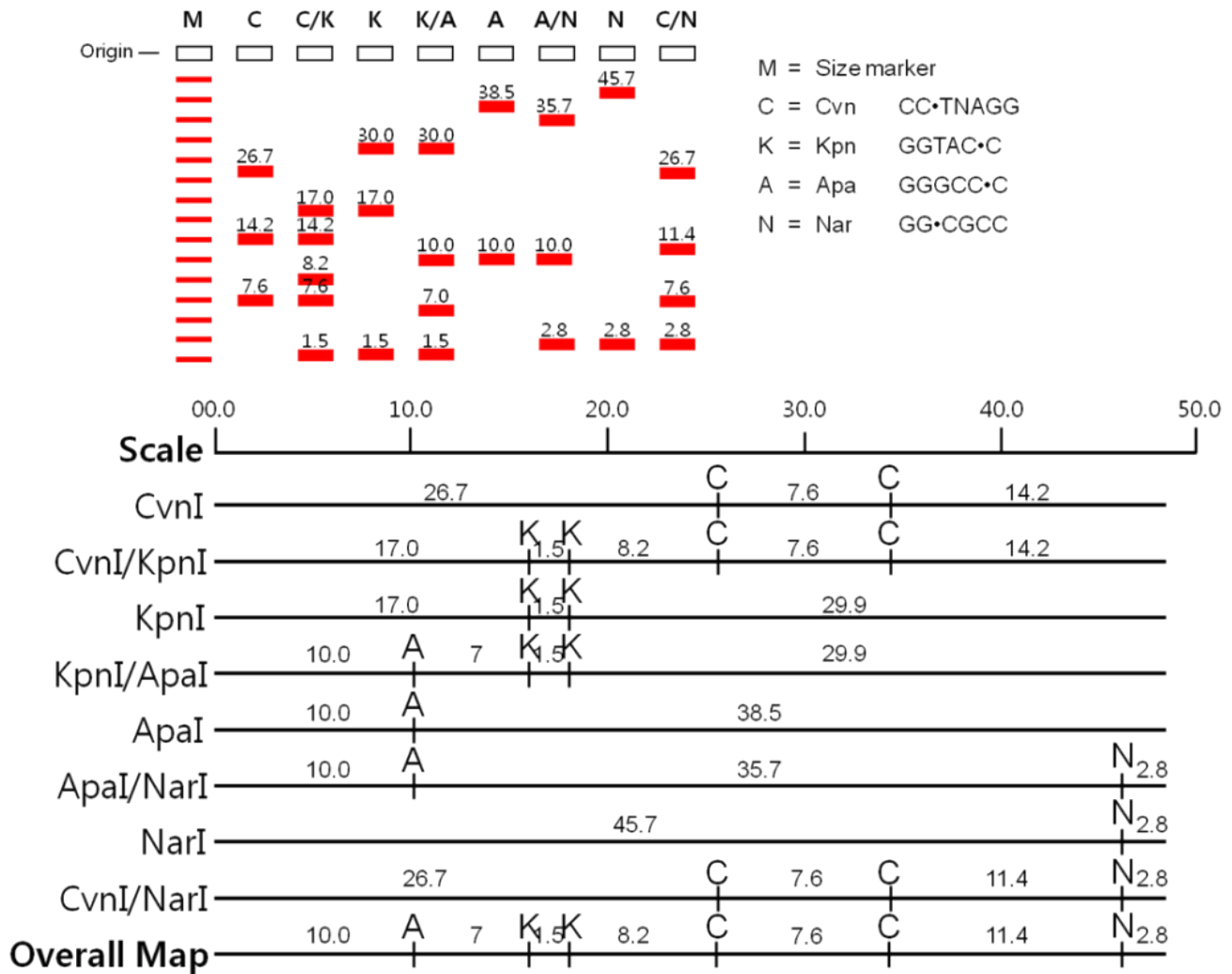

CHAPTER 13 - GENES AND COVID-19 SUSCEPTIBILITY IN HUMANS

13.1 Introduction

Learning Objectives

- Describe the basic mechanism by which SARS-Cov-2 infects humans.
- Identify some of the genes implicated in severe COVID-19 infection in humans.
- Describe the various approaches for vaccine development against SARS-Cov-2.

Coronaviruses are a group of RNA viruses (i.e., their genetic material is RNA, rather than DNA) which cause diseases in mammals and birds, such as respiratory tract infections, which generally range from mild to lethal. Mild illnesses in humans include some cases of the common cold (which is also caused by other viruses, such as rhinoviruses), while more lethal varieties can cause SARS, MERS, and COVID-19. The most recent common ancestor of all coronaviruses is estimated to have existed as recently as 8000 BCE, although some models place the common ancestor as far back as 55 million years or more, implying long term co-evolution with bat and avian species.

The Coronavirus disease 2019 (COVID-19) is a contagious disease caused by severe acute respiratory syndrome coronavirus 2 (SARS-CoV-2 – **Figure 13.1.1**). The structural proteins of SARS-CoV-2 include membrane glycoprotein (M), envelope protein (E), nucleocapsid protein (N), and the spike protein (S). The S-protein is the viral component that attaches to the host receptor via the ACE2 receptors, which is an enzyme on the surface of many cell types which generates small proteins by cleaving the large protein angiotensinogen, which that then go on to regulate functions in the cell. The first known infections from SARS-CoV-2 were discovered in Wuhan, China, somewhere between November – December 2019. The disease has since spread worldwide, leading to an ongoing pandemic. The original source of viral transmission to humans remains unclear, as does whether the virus became pathogenic before or after the spillover event.

SARS-CoV-2 infects people of all ages. However, evidence to date suggests that two groups of people are at a higher risk of getting severe COVID-19 disease. These are older people (people over 60 years old) and those with underlying medical conditions (such as cardiovascular disease, diabetes, chronic respiratory disease, and cancer). The risk of severe disease gradually increases with age starting from around 40 years.

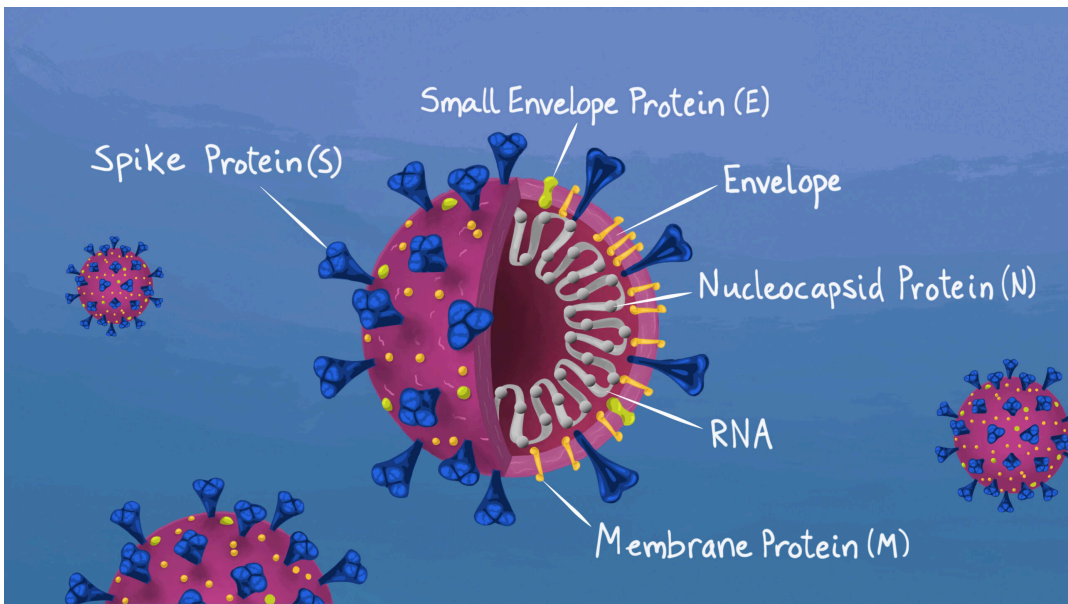

Figure 13.1.1 Anatomy of SARS-CoV-2 [[Long description](#)]

Take a look at the video below, *COVID-19 | Coronavirus: Epidemiology, Pathophysiology, Diagnostics*, by Ninja Nerd (2020) on YouTube, which summarizes some important and interesting facts about coronaviruses from the Government of Canada (2020).

A YouTube video thumbnail. On the left, a man in a white lab coat, identified as Professor Zach Murphy, is smiling. The background is a colorful, hand-drawn diagram of the human respiratory system, including the lungs, trachea, and nasal cavity. The diagram is labeled with 'NINJA NERD' in large, stylized letters. In the center, a white sign with blue text reads 'COVID-19 LECTURE #1'. Below the sign, a small cartoon character with glasses and a black hood is visible. The overall style is educational and engaging.

A YouTube element has been excluded from this version of the text. You can view it online here:
<https://open.genetics.pressbooks.tru.ca/?p=2020>

Media Attribution

- **Figure 13.1.1** [SARS-CoV-2, anatomy/anatomía](#) by Maya Peters Kostman for the [CC BY-NC-SA 4.0](#), Innovative Genomics Institute

Reference

Health Canada. (2020, March). COVID-19 | Coronavirus: Epidemiology, pathophysiology, diagnostics [Video file]. YouTube. <https://www.youtube.com/watch?v=PWzbArPgo-o>

Long Description

- **Figure 13.1.1** The anatomy of the SARS-Cov-2 virus, with the spike proteins on the surface shown, along with various membrane proteins, nucleocapsid proteins, small envelope proteins, along with membrane envelopes and RNA molecules within. [Back to [Figure 13.1.1](#)]

13.2 How Does SARS-CoV-2 Infect Humans?

In order to develop effective strategies to diagnose, treat, and manage this disease, it is vital to understand exactly how SARS-CoV-2 enters human cells. The virus' surface spike protein mediates SARS-CoV-2 entry into cells by binding to the ACE2 (Angiotensin-converting enzyme 2) receptor in humans through its receptor-binding domain and is proteolytically activated by human proteases. Cell entry of SARS-CoV-2 is preactivated by proprotein convertase furin, reducing its dependence on target cell proteases for entry, thus making it more efficient in cell entry and infection.

In humans, the ACE2 receptor protein is present in many cell types (especially epithelial cells) and tissues including the nose, mouth, lungs, heart, blood vessels, kidneys, liver, and gastrointestinal tract. ACE2 assists in modulating the activities of a protein called angiotensin II (ANG II) which increases blood pressure and inflammation, thereby increasing damage to blood vessel linings and promotes various types of tissue injury. ACE2 converts ANG II to other molecules which effectively counteract the effects of ANG II, such as inflammation and cell death. When the SARS-CoV-2 virus binds to the ACE2 receptor, it prevents ACE2 from performing its normal function to regulate ANG II signaling. As such, ACE2 action is inhibited, removing the protective mechanism from ANG II signaling through increased availability of ANG II to injure tissues, especially in the lungs and heart. **Figure 13.2.1** summarizes the transmission and life-cycle of SARS-CoV-2 causing COVID-19.

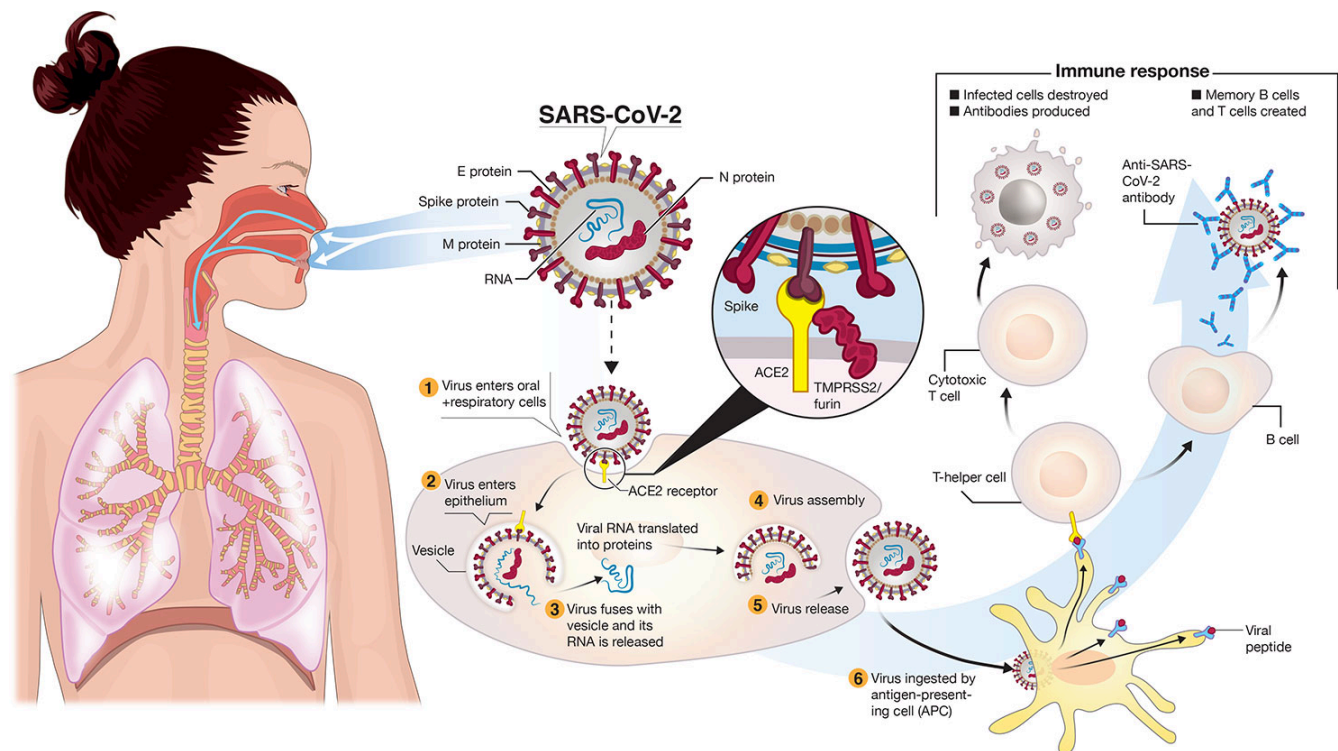
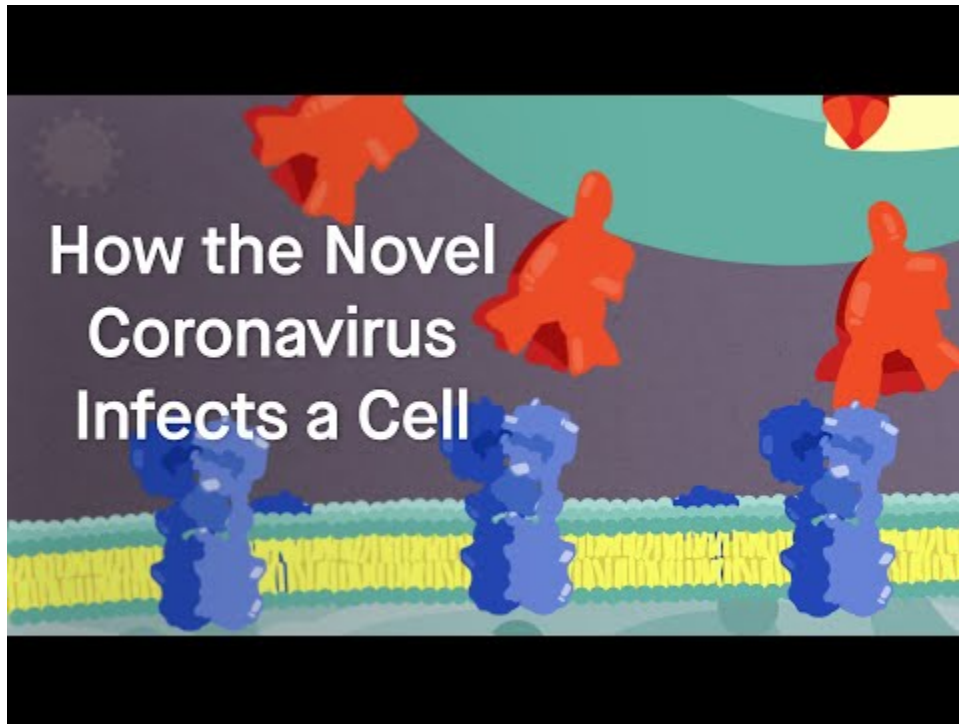

Figure 13.2.1 Transmission and Life-Cycle of SARS-CoV-2 Causing COVID-19. SARS-CoV-2 is transmitted via respiratory droplets of infected cases to oral and respiratory mucosal cells. The virus, possessing a single-stranded RNA genome wrapped in nucleocapsid (N) protein and three major surface proteins: membrane (M), envelope (E) and Spike, replicates and passes to the lower airways potentially leading to severe pneumonia. The gateway to host cell entry (magnified view) is via Spike-converting enzyme 2 (ACE2) interaction with cleavage of Spike in the prefusion state by proteases TMPRSS-2/furin. A simplified depiction of the life cycle of the virus is shown along with potential immune responses elicited. [[Long description](#)]

Take a look at the video below, *How the Novel Coronavirus Infects a Cell: Science, Simplified*, by Scripps Research (2020) on YouTube, describing how the novel coronavirus that causes COVID-19 enters the body and infects cells. Illustrated by a Scripps Research scientist, this installment of *Science, Simplified* gives an overview of the entire infection process.



A YouTube element has been excluded from this version of the text. You can view it online here:

<https://openogenetics.pressbooks.tru.ca/?p=2030>

Media Attribution

- **Figure 13.2.1** [Fphar-11-00937-g001](#) by Colin D. Funk, Craig Laferrière, and Ali Ardakani (2020), [CC BY 4.0](#), via Wikimedia Commons

Reference

Funk, C. D., Laferrière, C., Ardakani, A. (2020, June 19). A snapshot of the global race for vaccines targeting SARS-CoV-2 and the COVID-19 pandemic. *Frontiers in Pharmacology* 11. <https://doi.org/10.3389/fphar.2020.00937>

Scripps Research. (2020, July 13). How the novel coronavirus infects a cell (video file). YouTube. <https://youtu.be/dA70ZdYhhCg>

Long Description

- **Figure 13.2.1** Transmission and Life-Cycle of SARS-CoV-2 Causing COVID-19. SARS-CoV-2 is transmitted via respiratory droplets of infected cases to oral and respiratory mucosal cells. The virus, possessing a single-stranded RNA genome wrapped in nucleocapsid (N) protein and three major surface proteins: membrane (M), envelope (E) and Spike, replicates and passes to the lower airways potentially leading to severe pneumonia. The gateway to host cell entry (magnified view) is via Spike-converting enzyme 2 (ACE2) interaction with cleavage of Spike in the prefusion state by proteases TMPRSS-2/furin. A simplified depiction of the life cycle of the virus is shown along with potential immune responses elicited. [Back to [Figure 13.2.1](#)]

13.3 Genes Implicated in Severe COVID-19 Infection in Humans

Overview

The information in this section (Overview) was extracted from Elhabyan, A. et al. (2020), [The role of host genetics in susceptibility to severe viral infections in humans and insights into host genetics of severe COVID-19: A systematic review.](#)

Susceptibility to severe viral infections was reported to be associated with genetic variants in immune response genes. This article systematically reviewed the genes related to viral susceptibility that were reported in human genetic studies (case-reports and genome wide association studies) to understand the role of host viral interactions and to provide insights into the pathogenesis of severe COVID-19. Approximately 15% of cases are severe and some of them are accompanied by a dysregulated immune system and cytokine storm. There is increasing evidence that severe manifestations of COVID-19 might be attributed to human genetic variants in genes related to immune deficiency and/or inflammasome activation (cytokine storm). Forty genes were found to be associated with viral susceptibility and 21 of them were associated with severe SARS-CoV disease and severe COVID-19. Some of those genes were implicated in toll-like receptor pathways, others in C-lectin pathways, and others were related to inflammasome activation (cytokine storm).

Table 13.1 Summary of Review (Elhabyan et al., 2020) – Showing Genes Associated with Clinical Manifestation of SARS-CoV-2

Clinical Manifestation	Genes Associated
Susceptibility to SARS-CoV infection	CD14, HLA-B, FCGR2A, CCL2, CCL5, MxA, ABO, MBL, OAS-1, ICAM3, DC-SIGN
Susceptibility to SARS-CoV2 infection	ALOXE3, TMEM181, BRF2, ERAP2, LC6A20, LZTFL1, CCR9, FYCO1, CXCR6, XCR1, ABO, Apo

A Closer Look at Popular Theories

As researchers work tirelessly to uncover the genetic basis of COVID-19 severity and susceptibility, the following outlines some popular opinions based upon the science, as it stands when this was written. As the science advances, so will our theories and understanding.

- Emily Willingham’s (2020) article, [“Genes May Influence COVID-19 Risk, New Studies Hint”](#) at *Scientific American*, and Jocelyn Kaiser’s (2020) article, [“Found: genes that sway the course of the coronavirus”](#) at *Science* from American Association for the Advancement of Science. speak to early theories concerning **Chromosome 3 and ABO blood groups**.
- Another article from from Ann Gibbons (2020) at *Science*, [“Neanderthal gene found in many people may open cells to coronavirus and increase COVID-19 severity”](#) discusses the theory related to **Chromosome 2, specifically the DPP4 gene known as the Neanderthal gene** found in many people which may open cells to coronavirus and increase COVID-19 severity.

- An article from the National Institutes of Health (NIH, 2020), “[Scientists discover genetic and immunologic underpinnings of some cases of severe COVID-19](#)” speaks to a molecular explanation for **why more men than women die from COVID-19**.
- An article from John Hewitt (2020), *Medical Xpress*, “[Unique susceptibility to unique Sars-CoV-2 variants and vaccines](#)” gives a brief overview of how **individuals with different genetic variants in their immune system** components often have very different immune responses to SARS-CoV-2, and explains that they also will have different responses to vaccines.

Take a look at the video below by Dr. Alex Hoischen, Radboud University (Bionano Genomics, 2021), where he discusses his published results on genomic variants found in families with severe COVID-19. In two families with severely ill brothers, mutations were found in the Toll-Like Receptor 7 gene (TLR7), which affects the production of interferons, signaling molecules used to control the immune response. Several other studies have since made similar findings in other genes of the TLR family. Dr. Hoischen discussed how individual patients each may carry individually rare variants, that are collectively common and point to important pathways involved in the disease. His interest in the consortium is based on his understanding that larger SVs have a greater chance to be rare and disruptive, and genome-wide studies have lacked so far in their assessment.

The video below, *Rare Genetic Variants May Predispose to Severe COVID-19*, by Bionano Genomics (2021) on YouTube, discusses the links between genes and incidence of severe COVID-19 infection.

Rare genetic host factors in severe COVID-19

Presence of Genetic Variants Among Young Men With Severe COVID-19

Filtering step	Family 1 B-1	Segregate in Family 1 B-2	Family 2 B-1	Segregate in Family 2 B-2	Overlapping genes
Rare (<0.1% population frequency), loss-of-function coding variants	141	70	403	232	2 (TLR7, PLEKHA7)
Predicted LoF variants and highly conserved missense variants (PhyloP>3)	66	31	168	92	1 (TLR7)
Variants in genes with previous link to immune function	12	6	18	11	1 (TLR7)
Most interesting candidate gene	TLR7		TLR7		TLR7

Radboudumc

A YouTube element has been excluded from this version of the text. You can view it online here:

<https://opengenetics.pressbooks.tru.ca/?p=2032>

References

- Bionano Genomics. (2021, January 22). Rare genetic variants may predispose to severe COVID-19 (video file). YouTube. <https://www.youtube.com/watch?v=RaustWij4yg>
- Elhabyan, A. et. al. (2020). The role of host genetics in susceptibility to severe viral infections in humans and insights into host genetics of severe COVID-19: A systematic review. *Virus Research* 289(2020), 198163. <https://doi.org/10.1016/j.virusres.2020.198163>
- Gibbons, A. (2020, December 18). Neanderthal gene found in many people may open cells to coronavirus and increase COVID-19 severity. *Science*. <https://www.science.org/content/article/neanderthal-gene-found-many-people-may-open-cells-coronavirus-and-increase-covid-19>
- Hewitt, J. (2020, December 30). Unique susceptibility to unique Sars-CoV-2 variants and vaccines. *Medical Xpress*. <https://medicalxpress.com/news/2020-12-unique-susceptibility-sars-cov-variants-vaccines.html>
- Kaiser, J. (2020, October 13). Found: genes that sway the course of the coronavirus. *Science* 370(6514), 275-276. <https://www.science.org/doi/10.1126/science.370.6514.275>
- National Institutes of Health (NIH). (2020, September 24). Scientists discover genetic and immunologic underpinnings of some cases of severe COVID-19. U.S. Department of Health and Human Services. <https://www.nih.gov/news-events/news-releases/scientists-discover-genetic-immunologic-underpinnings-some-cases-severe-covid-19>
- Willingham, E. (2020, July 21). Genes may influence COVID-19 risk, new studies hint. *Scientific American*. <https://www.scientificamerican.com/article/genes-may-influence-covid-19-risk-new-studies-hint/>

13.4 Approaches for Vaccine Development Against SARS-CoV-2

The elucidation of the genome organization and functional domains of S protein for SARS-CoV (**Figure 13.4.1**), achieved through the work of scientists and geneticists all over the globe, has facilitated a deep understanding of the mode of action of this virus which has led to the development of a myriad of vaccine and drug candidates in an effort to mitigate the spread of this virus, as well as to assist in the diagnosis and management of infected patients.

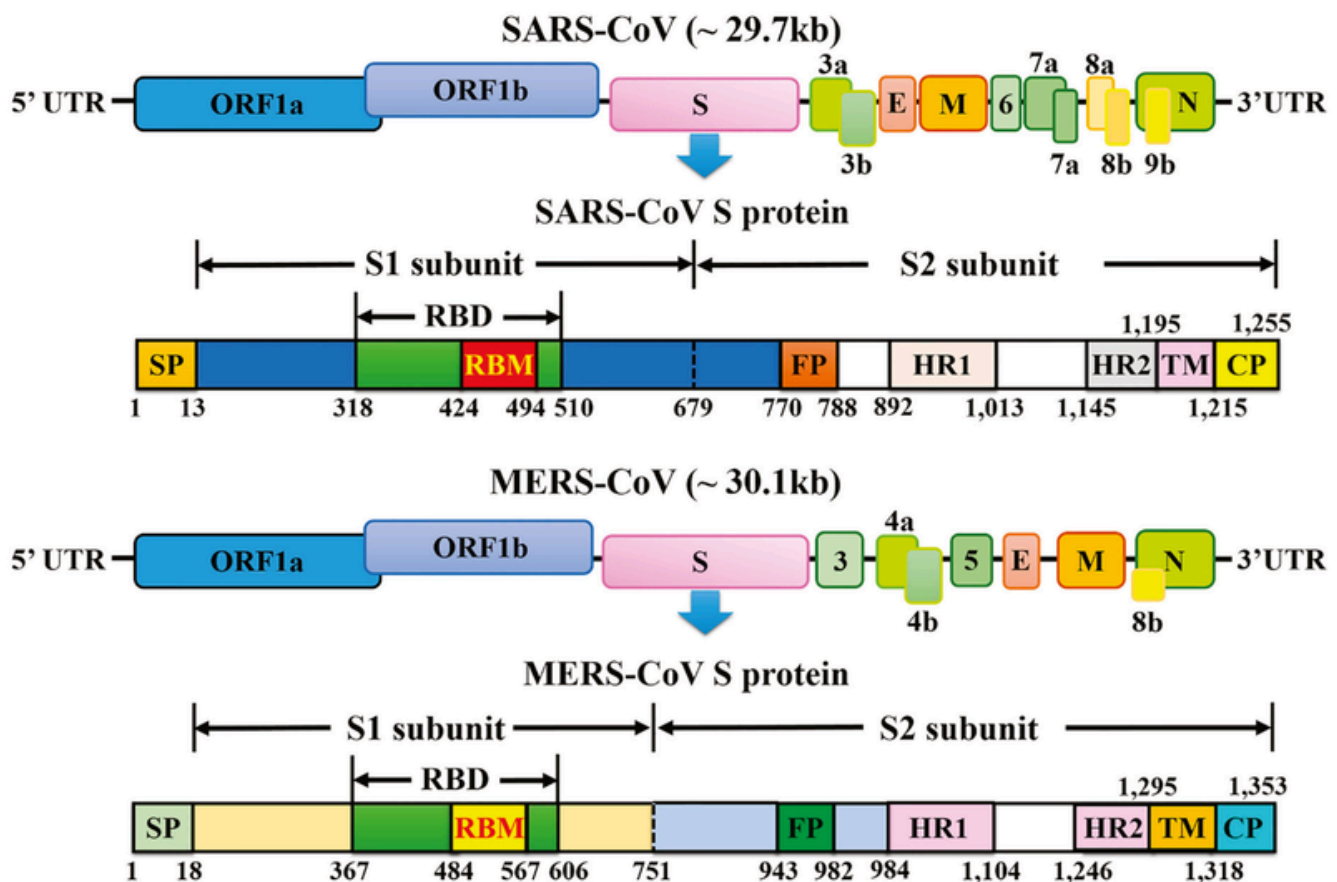

Figure 13.4.1 Schematic Representation of the Genome Organization and Functional Domains of S Protein for SARS-CoV and MERS-CoV. [\[Long description\]](#)

Figure 13.4.1 is a schematic representation of the genome organization and functional domains of S protein for SARS-CoV and MERS-CoV. The single-stranded RNA genomes of SARS-CoV and MERS-CoV encode two large genes, the ORF1a and ORF1b genes, which encode 16 non-structural proteins (nsp1–nsp16) that are highly conserved throughout coronaviruses. The structural genes encode the structural proteins, spike (S), envelope (E), membrane (M), and nucleocapsid (N), which are common features to all coronaviruses. The accessory genes (shades of green) are unique to different coronaviruses in terms of number, genomic organization, sequence, and function. The structure of each S protein is shown beneath the genome organization. The S protein mainly contains the S1 and S2 subunits. The residue numbers in each region represent their positions in the S protein of SARS and MERS, respectively. The S1/S2 cleavage

sites are highlighted by dotted lines. SARS-CoV, severe acute respiratory syndrome coronavirus; MERS-CoV, Middle East respiratory syndrome coronavirus; CP, cytoplasm domain; FP, fusion peptide; HR, heptad repeat; RBD, receptor-binding domain; RBM, receptor-binding motif; SP, signal peptide; TM, transmembrane domain.

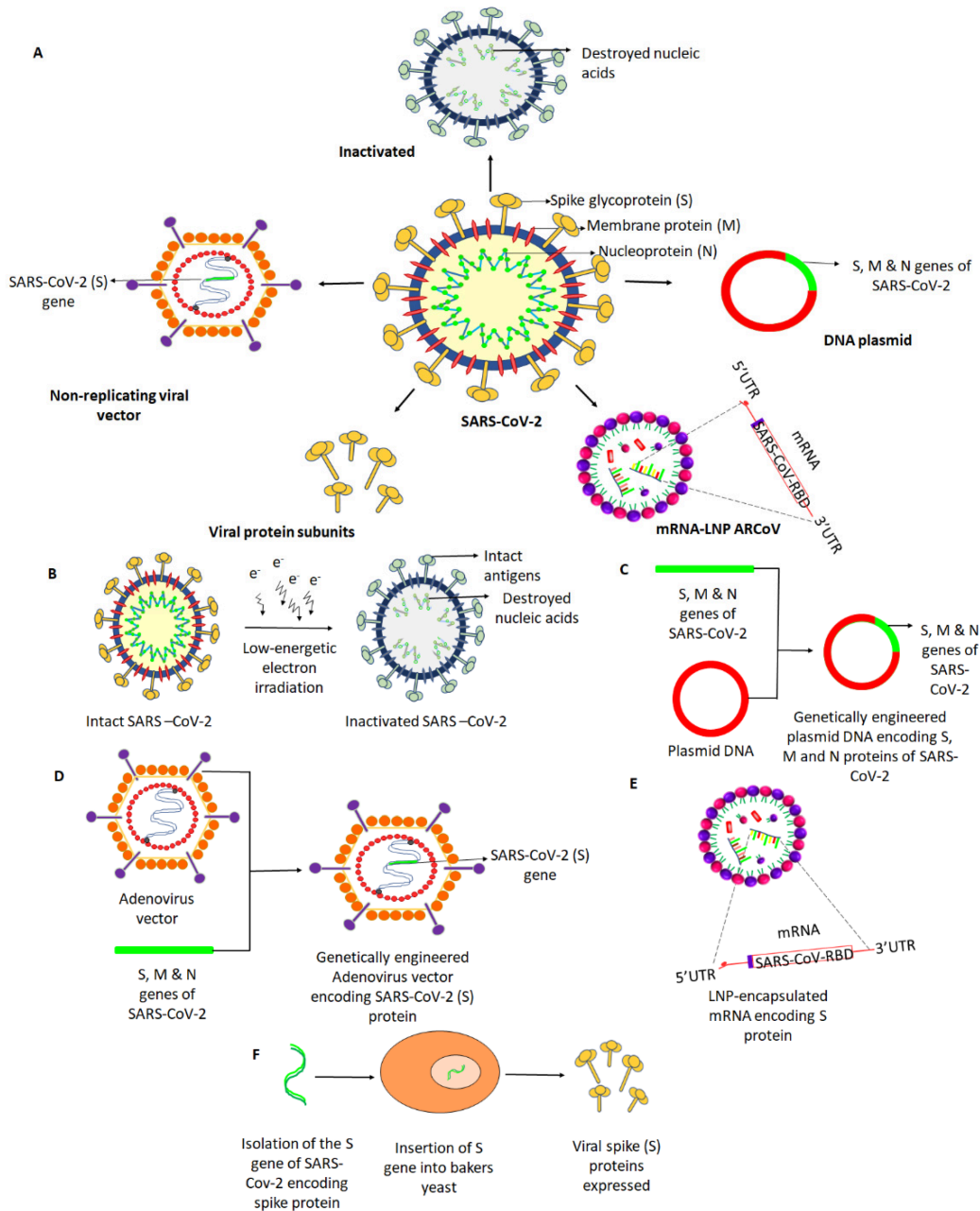

Figure 13.4.2 Different Approaches for the Development of Vaccine Candidates Against SARS-CoV-2 [[Long description](#)]

Different approaches for the development of vaccine candidates against SARS-CoV-2 have, and are being, developed and utilized. **Figure 13.4.2** summarizes these methods:

- A. Potential vaccines under development, involve five leading platforms (inactivated virus, protein subunit, DNA, RNA, and non-replicating viral vector), as depicted.
- B. Intact SARS-CoV-2 is neutralized by treatment with radiation to cease its ability to infect and replicate, while preserving the induction of an immune response.

- C. A plasmid DNA is genetically engineered with the S, M, and N genes of SARS-CoV-2 encoding the respective proteins that may facilitate an immune response.
- D. A replication-defective Adenovirus (Ad) vector is genetically engineered to express SARS-Cov-2 spike (S) protein.
- E. An mRNA (replication-defective) that encodes the S protein of SARS-CoV-2 is encapsulated in a lipid nanoparticle (LNP), which, when injected, induces the body cells to produce the spike protein and direct the immune response.
- F. Spike protein-encoding (S) gene of SARS-CoV-2 was isolated and genetically engineered into a baker's yeast, producing the spike protein antigens when grown. The produced S antigens can then be collected and purified.

Watch the video below called, *There are four types of COVID-19 vaccines: here's how they work*, by Gavi, the Vaccine Alliance (2020) on YouTube, which gives a brief overview of the main types of COVID-19 vaccines and the mechanism by which they bring about immunity in a patient.

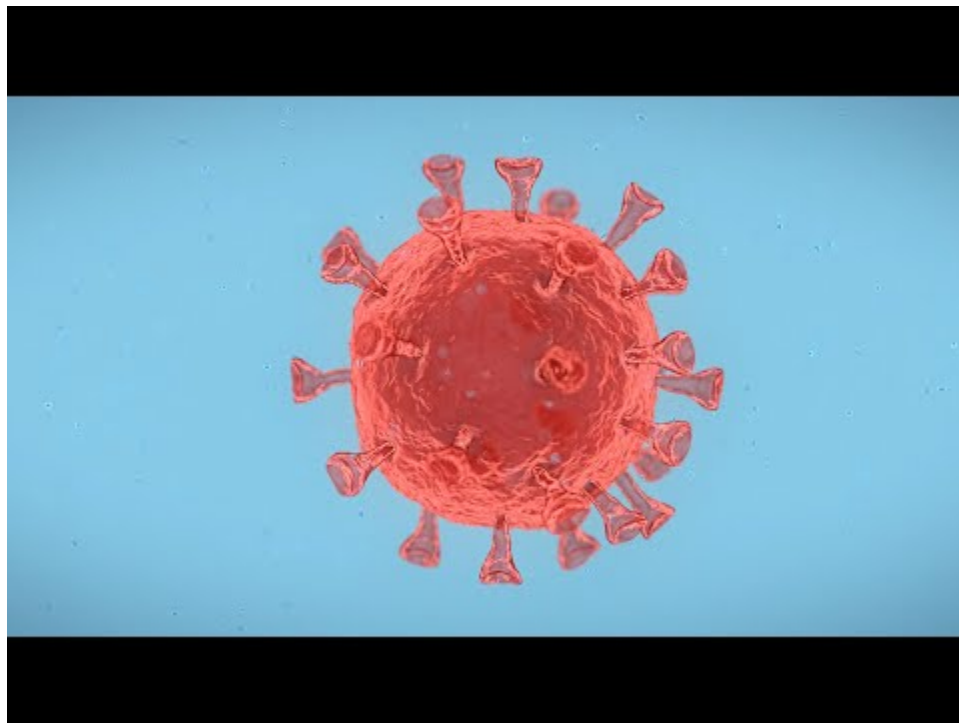

A YouTube element has been excluded from this version of the text. You can view it online here:

<https://opengenetics.pressbooks.tru.ca/?p=2028>

Media Attributions

- **Figure 13.4.1** [SARS-CoV MERS-CoV genome organization and S-protein domains](#) by Song, et al. (2019), [CC BY 4.0](#), via Wikimedia Commons
- **Figure 13.4.2** [Different approaches for the development of vaccine candidates against SARS-Cov-2](#) by Faheem et al. (2021), [CC BY 4.0](#), via Wikimedia Commons

References

- Faheem, M. S. et al. (2021). Platforms exploited for SARS-CoV-2 vaccine development. *Vaccines* 9(1), 11. <https://doi.org/10.3390/vaccines9010011>
- Gavi, the Vaccine Alliance. (2020, December 18). There are four types of COVID-19 vaccines: here's how they work (video file). YouTube. <https://www.youtube.com/watch?v=IFjVIlcCvc>
- Song Z et al. (2019, January 14). From SARS to MERS, Thrusting coronaviruses into the spotlight. *Viruses* 2019, 11(1), 59. <https://doi.org/10.3390/v11010059>

Long Descriptions

- **Figure 13.4.1** Schematic representation of the genome organization and functional domains of S protein for SARS-CoV and MERS-CoV. The single-stranded RNA genomes of SARS-CoV and MERS-CoV encode two large genes, the ORF1a and ORF1b genes, which encode 16 non-structural proteins (nsp1–nsp16) that are highly conserved throughout coronaviruses. The structural genes encode the structural proteins, spike (S), envelope (E), membrane (M), and nucleocapsid (N), which are common features to all coronaviruses. [Back to [Figure 13.4.1](#)]
- **Figure 13.4.2** Different Approaches for the Development of Vaccine Candidates Against SARS-Cov-2. (A) Potential vaccines under development involve five leading platforms (inactivated virus, protein subunit, DNA, RNA, and non-replicating viral vector), as depicted. (B) Intact SARS-CoV-2 is neutralized by treatment with radiation to cease its ability to infect and replicate, while preserving the induction of an immune response. (C) A plasmid DNA is genetically engineered with the S, M, and N genes of SARS-CoV-2 encoding the respective proteins that may facilitate an immune response. (D) A replication-defective Adenovirus (Ad) vector is genetically engineered to express SARS-Cov-2 spike (S) protein. (E) An mRNA (replication-defective) that encodes the S protein of SARS-CoV-2 is encapsulated in a lipid nanoparticle (LNP), which, when injected, induces the body cells to produce the spike protein and direct the immune response. (F) Spike protein-encoding (S) gene of SARS-CoV-2 was isolated and genetically engineered into a baker's yeast, producing the spike protein antigens when grown. The produced S antigens can then be collected and purified. [Back to [Figure 13.4.2](#)]

Chapter 13 Summary

The topics covered in this chapter can be summarized as follows:

- An introduction to the general group of RNA viruses known as coronaviruses with emphasis on the general structure of such viruses
- A summary of how the virus' surface spike protein mediates SARS-CoV-2 entry into human cells by binding to the ACE2 (Angiotensin-converting enzyme 2) receptor.
- A list of some of the genes Implicated in Severe COVID-19 Infection in Humans
- A discussion of the approaches for Vaccine Development Against SARS-Cov-2

Key Terms in Chapter 13

Key Terms – Genes and COVID-19 Susceptibility in Humans

- Angiotensin-converting enzyme 2
- C-lectin pathway
- Coronavirus
- Cytokine storm
- spike protein
- Toll-like receptor
- Vaccine

Appendix A: Key Milestones in Genetics and Molecular Biology Timeline

1859 *Natural Selection*



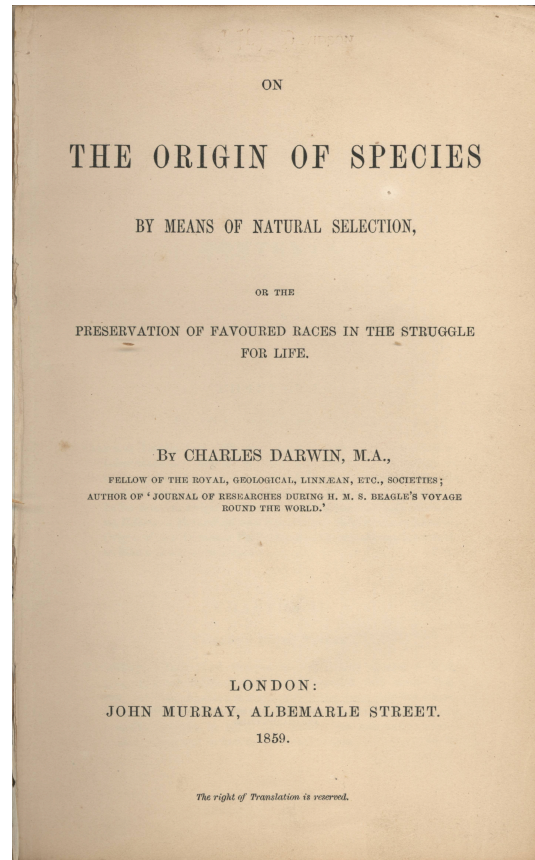











Charles Darwin wrote “*On the Origin of Species by Means of Natural Selection, or the Preservation of Favoured Races in the Struggle for Life.*”



The Origin of Species Title Page (1859)

1865 *Heredity Transmitted in Units*

Gregor Mendel's experiments on peas demonstrate that heredity is transmitted in discrete units. The understanding that genes remain distinct entities even if the characteristics of parents appear to blend in their children.

Characteristics of pea plants Gregor Mendel used in his inheritance experiments							
Seeds		Flower colour	Pod		Stem		size
form	cotyledons		form	colour	position of inflorescences	position of inflorescences	
 round roundish	 yellow	 white	 full	 yellow	 axial	 long	
 wrinkled	 green	 violet-red	 constricted between the seeds	 green	 terminal	 short	

Characteristics of Pea Plants Gregor Mendel Used in Inheritance Experiments

1869 *DNA Isolated*

Frederick Miescher isolates DNA from cells for the first time and calls it “nuclein.”



A Portrait of Friedrich Miescher (1844–1895)

1879 *Mitosis is Described*

Walter Flemming describes chromosome behavior during animal cell division. He stains chromosomes to observe them clearly and describes the whole process of mitosis in 1882.



A Portrait of Walther Flemming (1843–1905)

1902 *Chromosome Theory of Inheritance*

Walter Sutton observes that the segregation of chromosomes during meiosis matched the segregation pattern observed by Mendel.



A portrait of Walter S. Sutton (1877–1916)

1909 *The Word “Gene” is Coined*

Wilhelm Johannsen coins the word “gene” to describe the Mendelian unit of heredity. He also uses the terms genotype and phenotype to differentiate between the genetic traits of an individual and its outward appearance.

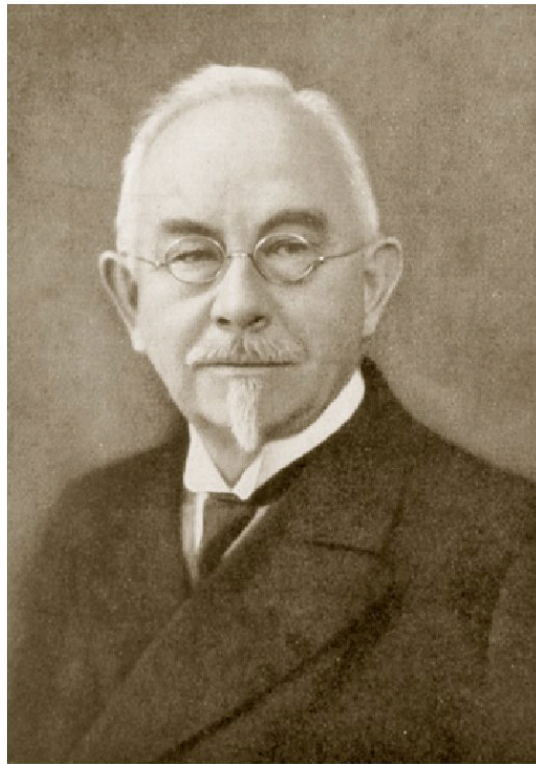

A Portrait of Wilhelm Johannsen (1857–1927), Danish Biologist

1911 Chromosomes Carry Genes

Thomas Hunt Morgan and his students study fruit fly chromosomes. They show that chromosomes carry genes and discover genetic linkage.

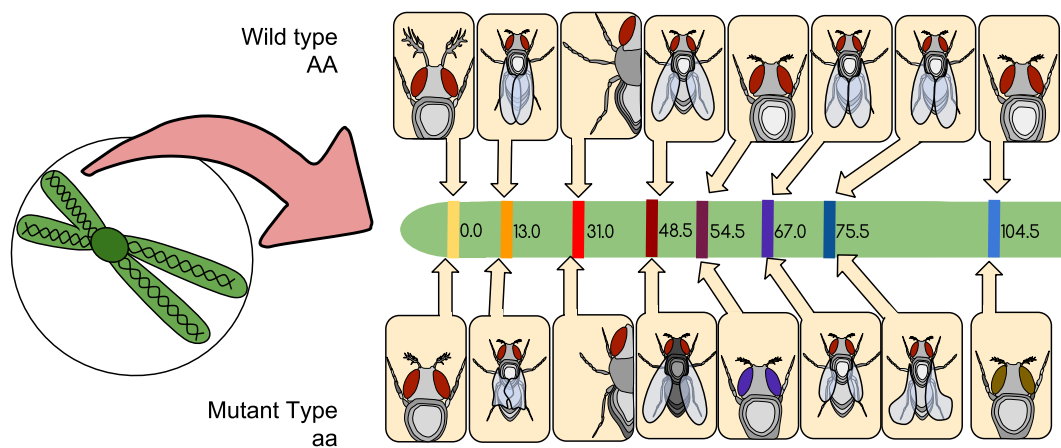

Drosophila (Common Fruit Fly) Gene Linkage Map

George Beadle and Edward Tatum's experiments on the red bread mold, *Neurospora crassa*, show that genes act by regulating distinct chemical events. They propose that each gene directs the formation of one enzyme.

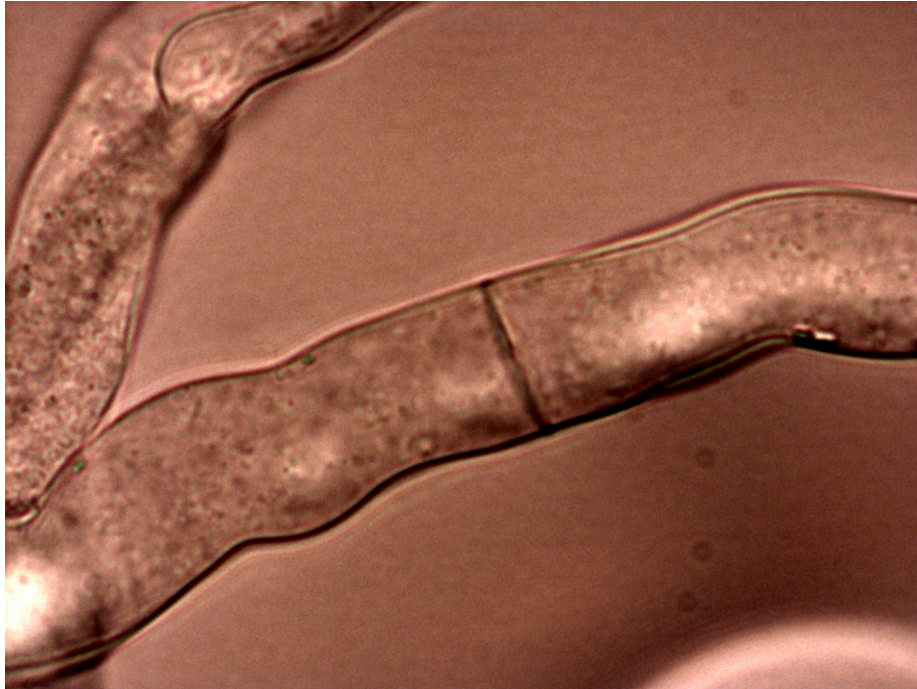

Neurospora Crassa hyphae (Red Bread Mold)

1952 *Genes are made of DNA*

Alfred Hershey & Martha Chase show that only the DNA of a virus needs to enter a bacterium to infect it, providing strong support for the idea that genes are made of DNA.



Scientists Martha Chase (1927–2003) and Alfred Hershey (1908–1997)

1953 **Double Helix**

Francis H. Crick and James D. Watson described the double helix structure of DNA. They received the Nobel Prize for their work in 1962.

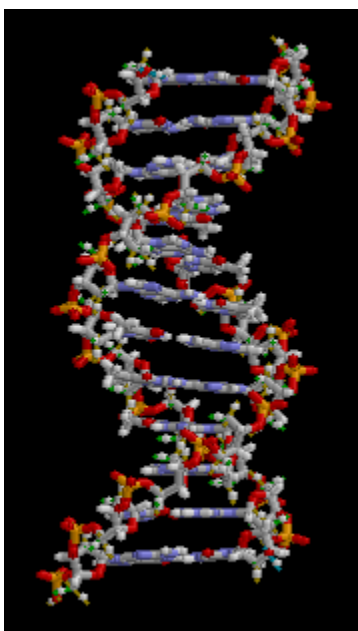

DNA Animation

Media Attributions

- **1859** *Natural Selection*: [The Origin of Species Title Page](#), from John Murray (Publisher), via Wikimedia Commons. [\[public domain\]](#)
- **1865** *Heredity Transmitted in Units*: [File:Gregor Mendel – characteristics of pea plants – english](#), by Scienza58 [username], via Wikimedia Commons. [\[Original image\]](#) by LadyofHats.] [CC0](#)
- **1869** *DNA Isolated*: [Friedrich Miescher \(scientist\)](#), by unknown artist, copied from <http://www.pbs.org/wgbh/nova/photo51/images/befo-miescher.jpg>, via Wikimedia Commons. [\[public domain\]](#)
- **1879** *Mitosis is Described*: [Walther Flemming \(1843 – 1905\)](#), by unknown author Original source: <http://www.laskerfoundation.org/news/gnn/timeline/1882a.html>, via Wikimedia Commons. [\[public domain\]](#)
- **1902** *Chromosome Theory of Inheritance*: [A portrait of Walter S. Sutton](#) taken prior to 1916; Original source from http://www.genomenetwork.org/resources/timeline/1902_Boveri_Sutton.jpg, via Wikimedia Commons. [\[public domain\]](#)
- **1909** *The Word “Gene” is Coined*: [Wilhelm Johannsen \(1857-1927\) Danish biologist](#), by unknown author, *The History of Biology* de Erik Nordenskiöld, Ed. Knopf, 1928, via Wikimedia Commons. [\[public domain\]](#)
- **1911** *Chromosomes Carry Genes*:
 - *Drosophila* Gene Linkage Map by Twaanders17, via Wikimedia Commons. [CC BY-SA 4.0](#)
 - *Neurospora crassa* hyphae by Roland Gromes, via Wikimedia Commons. [CC BY-SA 3.0](#)
- **1941** *One Gene, One Enzyme Hypothesis*: Scientists Alfred Hershey and Martha Chase, photograph by Rohit Kumar Sengupta, via Wikimedia Commons. [CC BY-SA 4.0](#)
- **1952** *Genes are made of DNA*: Scientists Alfred Hershey (1908–1997) and Martha Chase (1927–2003)
- **1953** *Double Helix*: [DNA animation \[gif\]](#) by brian0918 [username], via Wikimedia Commons. [\[public domain\]](#)

References

- A&E Television Networks. (2009, November 24). James D. Watson and Francis H.C. Crick (image). *Chemical structure of DNA discovered*. History.com. <https://www.history.com/this-day-in-history/watson-and-crick-discover-chemical-structure-of-dna>.
- Rohit Kumar Sengupta
- Murray, J. [publisher]. (2022, March 11). File:Origin of Species title page.jpg. *Wikimedia Commons*. https://commons.wikimedia.org/w/index.php?title=File:Origin_of_Species_title_page.jpg&oldid=637653752.
- Ruiz Villarreal, M. [user: ladyofhats]. (2018, October 9). File:Gregor Mendel – characteristics of pea plants – english [digital image – reworked by user: Scienza58]. *Wikimedia Commons*. https://commons.wikimedia.org/wiki/File:Gregor_Mendel_-_characteristics_of_pea_plants_-_english.png
- Wikipedia contributors. (2017, June 9). File:Friedrich Miescher.jpg. *Wikimedia Commons*. https://commons.wikimedia.org/w/index.php?title=File:Friedrich_Miescher.jpg&oldid=247219809
- Wikipedia contributors. (2021, February 16). Thomas Hunt Morgan. *Wikipedia*. https://en.wikipedia.org/w/index.php?title=Thomas_Hunt_Morgan&oldid=1007173283
- Wikipedia contributors. (2014, October 30). File:Walter sutton.jpg. *Wikimedia Commons*. https://commons.wikimedia.org/w/index.php?title=File:Walter_sutton.jpg&oldid=138199183 (Original source Genome News Network. (n.d.). [1902. Genetics and Genomics Timeline](http://www.genomenewsnetwork.org/resources/timeline/1902_Boveri_Sutton.php). http://www.genomenewsnetwork.org/resources/timeline/1902_Boveri_Sutton.php)
- Wikipedia contributors. (2020, August 12). File:Walther flemming 2.jpg. *Wikimedia Commons*. https://commons.wikimedia.org/w/index.php?title=File:Walther_flemming_2.jpg&oldid=438924135
- Wikipedia contributors. (2020, December 10). Wilhelm Johannsen. *Wikipedia*. https://en.wikipedia.org/w/index.php?title=Wilhelm_Johannsen&oldid=993478431